



# Parker Legris: Connecting You to the Best in Technology

aerospace  
climate control  
electromechanical  
filtration  
fluid & gas handling  
hydraulics  
pneumatics  
process control  
sealing & shielding



ENGINEERING YOUR SUCCESS.









A new Parker Legris catalogue is always an event.

We have updated the content so that this edition offers an even wider range of products for more applications: the range of LIQUIfit® fittings with metal adaptors for conveying beverages and fluids, the optic fibre range designed for "FTTx" infrastructures, as well as ranges specific to braking systems in trucks.

Our catalogue is available in different formats - paper, web, interactive - in order to facilitate product search. Stay connected, regardless of where you are: on the internet, a tablet, a smartphone...the information is just a click away!

Very complete and easy to use, this catalogue will be a useful tool, guiding you in the choice of solutions specific to your applications.

For advice or more information, please do not hesitate to contact us. Visit our web site today: [www.parkerlegris.com](http://www.parkerlegris.com).



# A Century of Dedication and Enthusiasm...

Inventor of the push-in fitting, Legris joined the Parker Hannifin Corporation, world leader in motion and control technologies, in October 2008.

## 3 Industrial Activities

Optimising the transport and control of many fluids (compressed air, liquids, gas) through innovative product design has been the motto of our teams for more than 100 years.

Today, Parker Legris' expertise is divided into three business activities:

**Legris Connectic:** fittings, couplers, function fittings, valves, tubing and accessories for industrial applications.

**Legris Transair:** air and fluid distribution systems for industrial buildings.

**Legris Autoline:** push-in connection solutions for automobile fuel lines.

## 150 Years of History

Our experience and expertise in the design, manufacturing and marketing of high-quality connectors allow us to provide our customers with solutions adapted to a variety of applications.

- 1848** Legris, a small valve manufacturer in France
- 1969** Invention of the LF 3000®, the first push-in fitting for compressed air
- 1988** Legris becomes a division of the Legris Industries Group

- 1996** Launch of Transair®
- 1997** Launch of Autoline
- 2008** Acquisition of Legris by the Parker Hannifin Corporation
- 2009** Legris becomes Parker Legris, a division of the Parker group





# ...Supporting Industrial Connectivity

## Parker Legris Sites

Parker Legris has 7 locations distributed across Europe.

**France:** Baillé, Guichen, Malestroit, Muzillac, Rennes

**Belgium:** Herstal

**Spain:** Terrassa

## Industrial Applications

Our products are used everywhere fluid control is required.

Our knowledge and expertise are deployed in a variety of sectors: production automation, packaging, transport, food process, and the medical industry.

Parker Legris is also involved in innovative sectors such as renewable energy, information and communication technologies.

## Our Distribution Network

We encourage local support and long-term partnerships with our customers.

Through our many sales outlets, professionals are on hand to provide you with technical advice and to offer you a wide choice of products local to your sites.

Do not hesitate to contact them for further information and advice.

1940



2012



# Your Applications Inspire Our Innovation

Innovation is Parker Legris' number one priority in order to provide solutions that meet your technological, energy reduction and environmental challenges.

## Our expertise is continually improving

We continually invest in our tools in order to anticipate market requirements in terms of industrial efficiency. Furthermore, our long-term partnerships with the most qualified organisations (universities, skills hubs, etc.) enable us to incorporate the latest technological advances in our product development. Lastly, constantly incorporating your needs into the design of our products keeps us at the forefront of the new industrial challenges.

## Together, we can build advanced and unique connector solutions

Here are a few examples:

### To increase the efficiency of your systems

The new LIQUIfit® range with metal adaptors - 316L stainless steel or FDA nickel-plated brass - designed for the transfer of industrial fluids, complements our push-in fitting range.

### To establish ultra high speed optic fibre networks

A brand-new range of push-in fittings combining transparency and proven technical characteristics has been developed. These connectors and gas blocks connect the micro-tubing that protects the optic fibre cables.

### To connect and ensure safe brake circuits for commercial vehicles

The Prestomatic ranges offer to this type of vehicle manufacturer the possibility of producing service brake circuits that meet strict safety requirements.

## This catalogue also contains details of our latest products:

Prestomatic 2, the PL range, customised products, promotional kits for blowguns, new technical characteristics for our standard ranges, new adaptors and much more.



# Quality and Safety, the Basis of Our Commitment

Our target is to provide our customers with the best solution and the highest quality. Certified ISO/TS 16949, Parker Legris includes customer quality at the heart of its processes.

## Invest in quality for increased productivity

The cost of a production stoppage due to a defective part is greater than the cost of all the connectors in the machine. Choosing the quality of the components in your machine is thus of primary importance; it also guarantees the safety and welfare of your employees. Furthermore, investing in quality increases your productivity over the long term and contributes to maintaining your brand image.

### We guarantee the quality and traceability of our solutions

Our products are fully inspected and dated individually during production in order to ensure quality and traceability.

We commit our name and our image to yours through the quality of our products.

### We protect your connectors to give you peace of mind

Our company exceeds its statutory responsibilities with regard to the safety of individuals and systems.

Certification and qualification processes are integrated upstream of our developments.

### We ensure the performance of your installations

Our product ranges are designed with a high safety factor and comply with quality management processes.

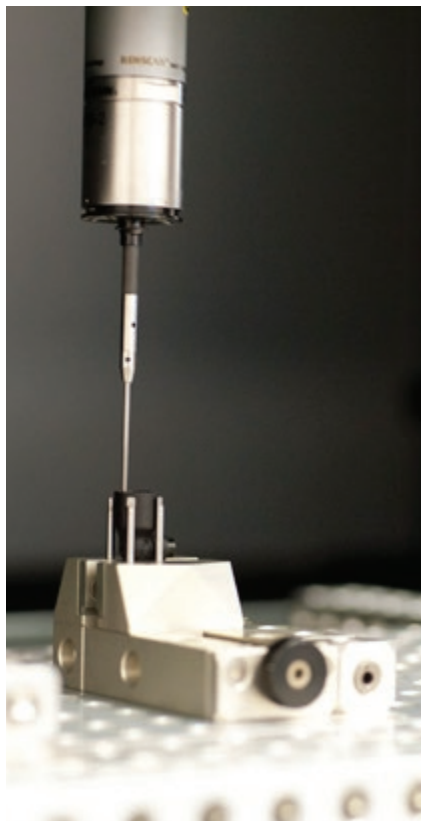



# Our Services Contribute to Your Performance

Our services integrate easily into your processes. Whether during the design phase, for promotion, or for administrative, business, or stock management of your components, our skills are here for you to use.

## Customised Products

We can help you develop customised solutions: fittings, manifolds, valves, etc.



## EDI Transmission

Implementation of computerised data exchange.

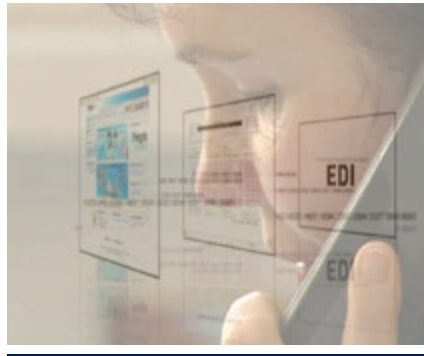

## Improved Stock Management

Packaging, bar codes and customised labels according to your needs.



## Technical Specifications

All the technical data for our products is available on-line.



## 2D and 3D Drawings

The CAD drawings of our products are available on-line in the 21 main formats used by the industry (Solidworks, Autocad, Pro/E, etc.).

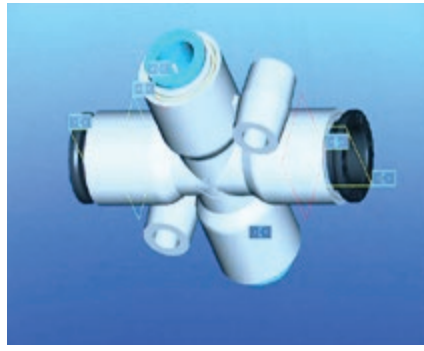

## Certificates and Regulations

Certificates of conformity for our products are available on our web site. Contact us for any further information you require.

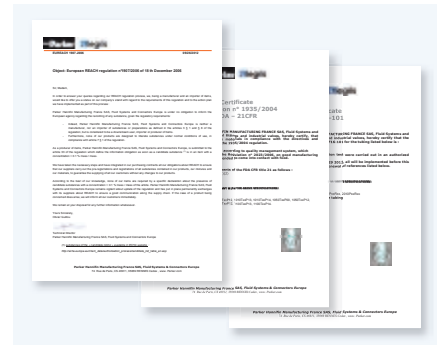

## e-Tools

Requests for quotations, stock availability, energy-saving calculators, searching for cross-references, etc. are available on-line.

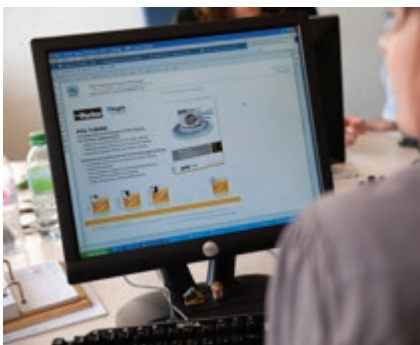

## Communication Tools

We can provide you with any promotional sales material you require: brochures, flash animations, sample kits, etc.



## e-Catalogue

Integration of our product data into your information systems (e-procurement, e-commerce site, etc.).





# Together, We Can Build Sustainable Development

Parker Legris, ISO 14001 certified, has made the conservation of resources and protection of the environment a major priority. Through our Eco-Design approach, we have incorporated improved environmental management as a permanent feature in the vision and mission of the company, aiming to benefit nature, technology and mankind.



## Protecting natural resources

By saving energy through the performance of our production facilities.

## Improving performance

By changing habits in order to promote new materials and concepts.

## Asserting our values for the protection of the environment

By having all our sites ISO 14001 certified in order to unify all our employees around clear objectives regarding the management of the environment.

## Our actions are coupled with your environmental process

### Reducing the impact on industrial sites

Parker Legris has integrated environmental protection management into the operation of its industrial sites. This approach has enabled 85% of waste to be recovered and has reduced energy consumption by 15%.

### Offering ecologically responsible products

Under its continuous improvement process, Parker Legris has integrated ecological design as an input parameter to innovation and uses Life Cycle Assessment (LCA) to optimise the environmental impact of its products.

### Providing information on the PEP (Product Environmental Profile)

This communication tool is common to all industries and professions and delivers a reliable and clear message for promoting ecological advances and incorporating this data within the LCA equipment.

### Getting ahead of regulations

Parker Legris goes beyond its statutory obligations and endeavours to find a good match between choice of materials, limitation of hazardous substances, selection of recycling channels and industrial performance to encourage the recycling of products at end of life.

## Using our technology reduces the environmental impact

LIQUIFIT®

### Tube-to-Tube Connector



Market Standard

### Tube-to-Tube Connector



- Parker Legris
- Market Standard in PP
- Market Standard in POM

### Tube-to-Tube Connector

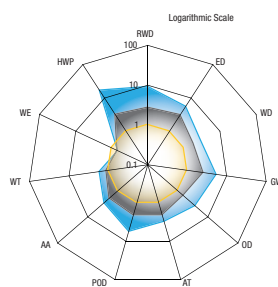

- RWD: Raw Material Depletion
- ED: Energy Depletion
- WD: Water Depletion
- GW: Global Warming

- OZ: Ozone Depletion
- AT: Air Toxicity
- POC: Photochemical Ozone Creation
- AA: Air Acidification

- WT: Water Toxicity
- WE: Water Eutrophication
- HWP: Hazardous Waste Production

### Generation 2



### Generation 3



Manufactured according to our continuous Eco-Design approach, the LF 3000® fitting optimises the environmental impact of the products.



**Global Warming:**  
Gains in terms of CO<sub>2</sub> rejection during a product's life cycle



# Directives and Regulations:

Parker Legris complies with the directives and regulations listed below and goes beyond its statutory obligations for the ranges in question.

## Industrial Regulations



**European RoHS directives: 2011/65/EC**  
Relating to the limitation of the use of 6 hazardous substances in electrical and electronic equipment (mercury, lead, cadmium, hexavalent chromium, PBB and PBDE).



**REACH regulation: 1907/2006**  
As a product manufacturer, we are subject to article 33 of the regulation which defines a duty to inform when a candidate substance is present at more than 0.1% weight for weight.



**Pressurised equipment directive: 97/23/EC**  
This directive regulates the design, manufacture and assessment of pressurised equipment to ensure operating safety.

**Machinery Directive 2006/42/EC**  
This directive harmonizes the safety and health requirements for machines with a high protection level. It also guarantees the free movement of machines on the European Union market.



**ATEX directive: 94/9/EC mandatory since 01/07/2003**  
This directive is mandatory for electrical and non-electrical equipment used in explosive gaseous or dusty atmospheres. The use of our products in these areas must be determined in accordance with the ATEX environment.



Pneumatic fluid power, push-in connectors for thermo-plastic tubing.



Standard for safety of flammability of plastic materials for parts in devices and appliances.



For grease only.  
Federal Institute for Materials Research and Testing  
Certification for the sensitivity to inflammation of oxygen gas.



Resistance to water and dust seepage

## Food Process Regulations and Certifications



**Regulation 1935/2004**  
This framework regulation relates to materials and objects designed to come into contact with foodstuffs. It describes specific measures per product group (Art. 5).



**CFR 21: Code of Federal Regulation  
Title 21: Food and Drugs**  
This code consists of lists of prohibited substances for materials intended to come into contact with foodstuffs.



**NSF 51: NSF / ANSI-51**  
Fittings and tubes complying with this standard are tested and approved by NSF for contact with drinks and foodstuffs.

## Quality Management Certification



**ISO TS 16949**  
Quality management systems - particular requirements for the application of ISO 9001:2000 for automotive production and relevant service part organizations.

**ISO 14001**  
Environmental management systems.  
Requirements with guidance for use.

**ISO 9001**  
This international standard specifies requirements for a quality management system when an organisation needs to demonstrate its ability to consistently provide products that meet customer and applicable statutory and regulatory requirements.

**Medical Devices - Quality Management Systems: Requirements for Regulatory Purposes**  
This international standard specifies requirements for a quality management system where an organisation needs to demonstrate its ability to provide medical devices and related services that consistently meet customer requirements and regulatory requirements applicable to medical devices and related services.

**ISO 13485**  
(pending)

The Parker Legris product range offers compliance with numerous European standards associated in particular with the directives and regulations referred to above. The official texts of these directives are available on the site: <http://eur-lex.europa.eu>.



# the Parker Legris Offer

## Water Treatment Certifications



**NSF 61: NSF / ANSI-61**  
Fittings and tubes complying with this standard are tested and approved by NSF for contact with drinking water.



**NSF 42 and 58: NSF/ANSI-42/58**  
Tubes complying with this standard are tested and approved by NSF for drinking water treatment systems.



**ACS: Attestation de Conformité Sanitaire** (France)  
Official approval issued by the Direction générale de la Santé Française (French Health Directorate), applies to constituent materials of equipment in contact with water intended for human consumption.

**KTW**

**KTW: Kunststoffe und Trinkwasser** (Germany)  
Guidelines for the health evaluation of equipment in contact with drinking water, assessment and certification carried out by the TZW.

**W270**

**W270: Food contact standard** (Germany)  
Standard describing a test method for determining the microbial growth on non-metal materials designed to come into contact with drinking water.  
Test and certification carried out by the TZW.



**WRAS: Water Regulations Advisory Scheme** (UK)  
Fittings approved by this programme are declared compliant for water supply by WRc - NSF.



**DM 174: Ministerial decree** (Italy)  
Declaration of hygiene compliance for equipment used for drinking water, tested and certified by the TIFQ.

## Regulations and Certifications for Life Sciences & Clean Room Applications

**USP  
Class VI (A)**

The United States Pharmacopeia (USP) establishes standards to ensure the quality of medicines and other health care technologies.

**ASTM G93**

**Standard Practice for Cleaning Methods and Cleanliness Levels for Material and Equipment Used in Oxygen-Enriched Environments**  
This practice covers the selection of methods and apparatus for cleaning materials and equipment intended for service in oxygen-enriched environments. Contamination problems encountered in the use of enriched air, mixtures of oxygen with other gases, or any other oxidizing gas may be solved by the same cleaning procedures applicable to most metallic and non-metallic materials and equipment.

**ISO 14644-1**

Clean Rooms and Associated Controlled Environments. Part 1: Classification of Air Cleanliness. The document covers the classification of air cleanliness in clean rooms and associated controlled environments exclusively in terms of concentration of airborne particles. Only particle populations having cumulative size distributions based on threshold (lower limit) size ranging from 0.1 <math>\mu\text{m}</math> to 5 <math>\mu\text{m}</math> are considered for classification purposes.

## Railway Regulations



**EN 45545-2**  
Railway applications - fire protection on railway vehicles. Requirements for fire behavior of materials and components.

**DIN 5510-2**  
Preventive fire protection in railway vehicles. Determines levels of protection, fire preventive measures and certification.

**NF F16-101**  
Method of classification of materials for rolling stock obtained from the results of standardised tests. Takes into account the combustion of the materials as well as the opacity and toxicity of emissions.



**EN 50086-2-4 replaced by NF EN 61386-24**  
Standard related to impact tests for buried systems.

**EN 50411-2-8**  
Fibre organisers and closures to be used in optical fibre communication systems.

## Regulations and Standards for Transportation



**EURO 6**  
Standard that reduces the level of certain polluting gases.

**DIN 74324, DIN 73378**  
Specification and tests related to thermoplastic tubing.

# Technical Guidelines

## Compressed Air Flow and Pressure Drop

Flow represents the quantity of compressed air passing through a section per unit time. It is expressed in l/min, m<sup>3</sup>/min or m<sup>3</sup>/h, at the value expressed in free air, under Standard Reference Atmospheric conditions (ANR) namely: **+20°C, 65 % relative humidity, 1.013 bar**, according to standards NFE 48100 and ISO R554, R558.

When in open position and subject to a supply pressure (**P**), the pneumatic component provides a flow (**d**) which generates a pressure drop at the outlet. The pressure difference therefore between the inlet orifice (upstream pressure) and the outlet orifice (downstream pressure), is called the **pressure drop** and is designated by **ΔP** (pressure differential).

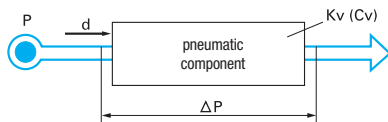

The **maximum allowable working pressure** of a component is the effective pressure to which this component may be subjected in a given installation.

The **upstream pressure** is the compressed air pressure at the component inlet.

The **downstream pressure** is the outlet pressure from the component.

The **differential pressure (ΔP)** is the pressure difference between the upstream and downstream pressures.

In order to have simple and usable values available for carrying out calculations and comparing the performances of pneumatic components, we use a flow factor called **Kv**. This experimental factor characterises the flow capacity of a component. It equates to the practical value of the flow of water in litres/minute under a Δp of 1 bar with bore fully open.

The flow factor Kv equates to a coefficient of conductivity - the higher its value, the better the flow provided by the component.

The Kv and pressure drop are linked by the following relationship:

$$Q_v = 26.7 K_v \sqrt{\Delta p \times P_{\text{upstream}}}$$

**Q<sub>v</sub>** = flow in l/min (ANR)

**K<sub>v</sub>** = flow factor

**Δp** = in bar

**P upstream:** in bar absolute

**Cv** is a flow factor equivalent to Kv, but expressed in US gallons per minute under a Δp of 1 PSI. Kv and Cv are therefore linked by the following relationships:

$$K_v = 14.3 C_v \quad - \quad C_v = 0.07 K_v$$

The flow indicated for certain products in the Parker Legris catalogue is the average flow at 6 bar expressed in NI/min of depressurised air at the Standard Reference Atmosphere (ANR).

## Pressure

The normal atmospheric pressure of the air is 1.013 bar at sea level (0 m altitude). It is generally used as a reference for pressure measurements but varies with altitude. For tests and measurements, it is preferable to use absolute bar which relates to an absolute pressure.

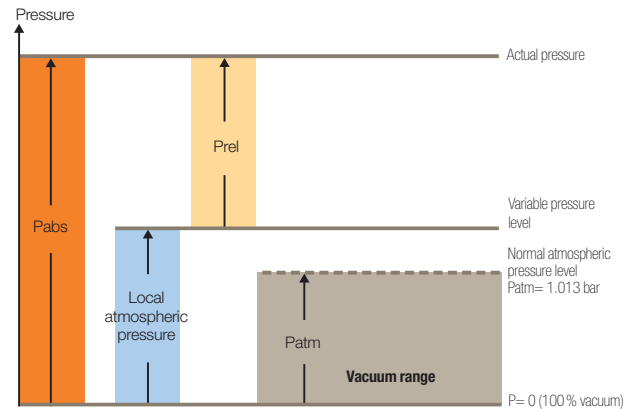

$$P_{abs} = P_{atm} + P_{rel}$$

**Pabs** : absolute pressure

**Prel** : relative pressure

**Patm** : atmospheric pressure

The pressure is expressed in bar according to industrial practice. It is the result of a force of daN applied to a surface area in cm<sup>2</sup>.

$$1 \text{ bar} = \frac{1 \text{ daN}}{1 \text{ cm}^2} = 10^5 \text{ pascal}$$

## Vacuum and Vacuum Levels

Vacuum appears when the atmosphere is rarefied. By removing the air from an enclosed space, a depression (or vacuum) is created relative to atmospheric pressure.

Vacuum therefore relates to the state of a fluid where the pressure is less than atmospheric pressure.

The vacuum level may be expressed as:

**depression level** = relative pressure value compared to atmospheric pressure

**vacuum level** in absolute value (defined in comparison with absolute zero)

The common unit of vacuum is the millimetre of mercury (**mm Hg**).

Classification of vacuum

• medium vacuum	10 <sup>13</sup>	to	10 mbar absolute
• primary vacuum	10	to	10 <sup>-3</sup> mbar absolute
• secondary vacuum	10 <sup>-3</sup>	to	10 <sup>-6</sup> mbar absolute
• molecular vacuum	10 <sup>-6</sup>	to	10 <sup>-9</sup> mbar absolute
• ultra-vacuum			< 10 <sup>-9</sup> mbar absolute

# Conversion Tables

## Units Used in this Catalogue

1 meter = 3.281 feet  
1 foot = 0.30480 meters

Symbol	Unit
A	ampere
bar	bar
°C	degree Celsius
dBA	decibel
Hz	hertz
kg	kilogram
m	metre
m²	square metre
m³/h	cubic metres per hour
min	minute
mm	millimetre
mm Hg	millimetres of mercury
N	Newton
NI	litres at standard reference atmospheric pressure (ANR)*
V	volt

## Units of Flow

l/min	Cfm	m³/h
600	21	36
1200	43	72
1800	64	108
2400	85	144
3000	106	180
3600	128	216
4200	149	252
4800	170	288
5400	191	324
6000	213	360
6600	234	396
7200	255	432
7800	277	468

\*Parker Legris carries out its tests under normal pressure and temperature conditions (1013 mbar, +20°C). All flows mentioned in this catalogue are therefore expressed in NI/min.

## Units of Vacuum

Depression (mm Hg)	Vacuum (%)	Absolute Pressure (mbar)	Depression (mbar)
0	0	1000	0
-75	10	900	-100
-100	13.3	867	-133
-150	20	800	-200
-200	26.7	733	-267
-225	30	700	-300
-300	40	600	-400
-375	50	500	-500
-400	53.3	467	-533
-450	60	400	-600
-500	66.7	333	-667
-525	70	300	-700
-600	80	200	-800
-675	90	100	-900
-690	92	80	-920

## Units of Pressure

1 bar = 100.000 Pa = 100 kPa = 14.5 psi  
1 Pa = 0.00001 bar = 0.000145 psi  
1 psi = 0.069 bar = 6897.8 Pa

bar	kPa	psi	psi	kPa	bar
0.0005	0.05	0.0073	0.007	0.05	0.0005
0.001	0.10	0.0145	0.015	0.1	0.0010
0.005	0.5	0.0725	0.070	0.48	0.0048
0.01	1	0.145	0.150	1.04	0.0104
0.05	5	0.725	0.700	4.83	0.0483
0.069	6.9	1.000	1.000	6.90	0.0690
0.1	10	1.450	1.500	10.35	0.1035
0.25	25	3.625	3.000	20.70	0.2070
0.5	50	7.250	7.000	48.30	0.4830
0.75	75	10.875	10.000	69.00	0.6900
1.0	100	14.500	15.000	103.50	1.0350
1.5	150	21.750	20.000	138.00	1.3800
2.0	200	29.000	25.000	172.50	1.7250
2.5	250	36.250	30.000	207.00	2.0700
3.0	300	43.500	35.000	241.50	2.4150
3.5	350	50.750	40.000	276.00	2.7600
4.0	400	58.000	50.000	345.00	3.4500
4.5	450	65.250	60.000	414.00	4.1400
5.0	500	72.500	70.000	483.00	4.8300
5.5	550	79.750	80.000	552.00	5.5200
6.0	600	87.000	90.000	621.00	6.2100
7.0	700	101.500	100.000	690.00	6.9000
8.0	800	116.000	110.000	759.00	7.5900
9.0	900	130.500	125.000	828.00	8.2800
10.0	1000	145.000	150.000	1035.00	10.3500
12.0	1200	174.000	175.000	1207.50	12.0750
14.0	1400	203.000	200.000	1380.00	13.8000
16.0	1600	232.000	225.000	1552.50	15.5250
18.0	1800	261.000	250.000	1725.00	17.2500
20.0	2000	290.000	300.000	2070.00	20.7000

## Units of Temperature

0 °C = +32 °F  
0 °F = -17.8 °C

°F	°C	°C	°F
-40	-40.0	-40	-40
-30	-34.4	-30	-22
-20	-28.9	-20	-4
-10	-23.3	-10	+14
0	-17.8	0	+32
+10	-12.2	+10	+50
+20	-6.7	+20	+68
+30	-1.1	+30	+86
+40	+4.4	+40	+104
+50	+10.0	+50	+122
+60	+15.6	+60	+140
+70	+21.1	+70	+158
+80	+26.7	+80	+176
+90	+32.2	+90	+194
+100	+37.8	+100	+212
+110	+43.3	+110	+230
+120	+48.9	+120	+248
+130	+54.4	+130	+266
+140	+60.0	+140	+284
+150	+65.6	+150	+302
+160	+71.1	+160	+320
+170	+76.7	+170	+338
+180	+82.2	+180	+356
+190	+87.8	+190	+374
+200	+93.3	+200	+392
+210	+98.9	+210	+410
+220	+104.4	+220	+428
+230	+110.0	+230	+446
+240	+115.6	+240	+464
+250	+121.1	+250	+482

# Fitting Threads

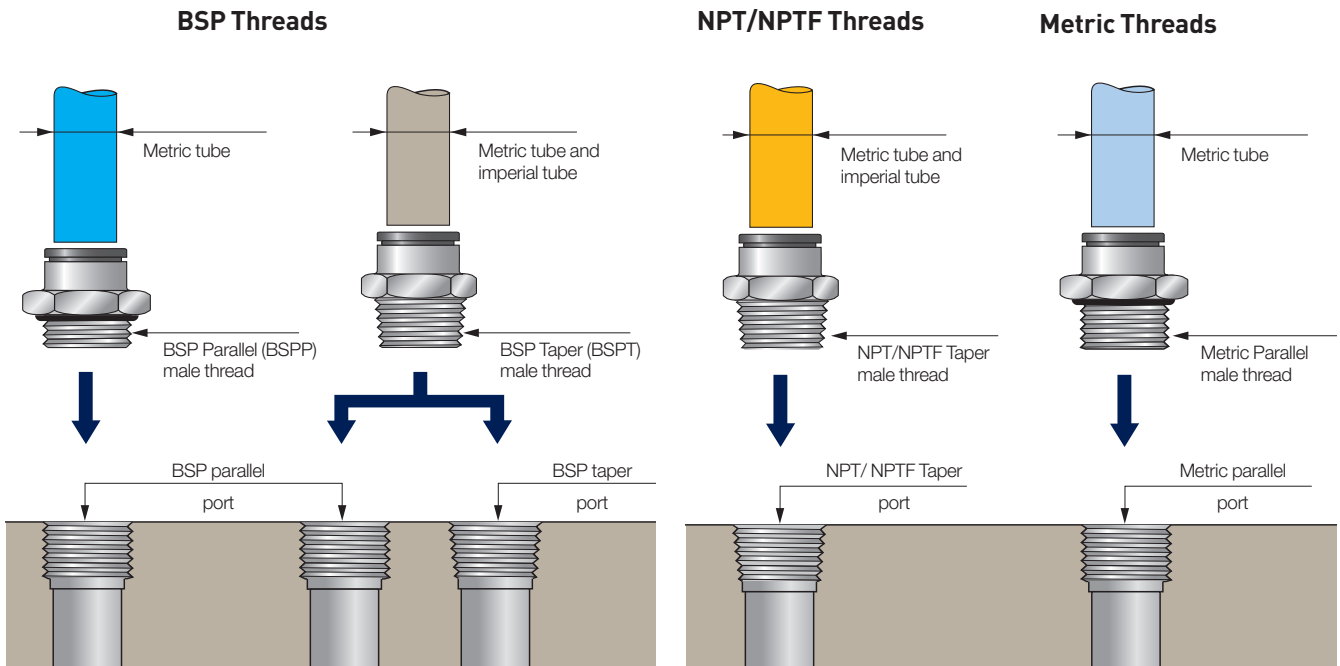

## BSP Threads (British Standard Pipe)

There are two types of "Pipe" profile threads:

- **Parallel (BSPP):** these threads fit in matching parallel ports. Sealing is provided by an O-ring gasket or a sealing washer.
- **Taper (BSPT):** these threads fit in matching parallel or taper ports. Sealing is provided by a pre-coating on the thread.

### Thread designation

#### • BSP Parallel (BSPP):

G followed by the denomination, according to standard ISO 228-1.  
Example: 1/8 BSP parallel thread = G1/8

#### • BSP Taper (BSPT):

R followed by the denomination, according to standard ISO 7-1.  
Example: 1/8 BSP taper (BSPP) thread = R1/8

#### • Female threads:

BSP parallel: G followed by the designation  
BSP taper: R followed by the designation

## NPT Threads (National Pipe Thread)

This is an American standard taper thread which fits into the matching taper port. Sealing is provided by a pre-coating on the thread.  
Example: 1/8 NPT thread = 1/8 NPT

## NPTF Threads (National Pipe Thread Fuel)

This is an American standard taper thread which fits into the same taper port with no additional sealing or into a taper port with a sealant.

## Metric Threads

These ISO-profile threads are parallel and are fit into the matching parallel port. Sealing is provided by an O-ring or a sealing washer.

### Thread designation

- M depending on the diameter and pitch in millimetres, separated by a multiplication sign, in accordance with standards ISO 68-1 and ISO 965-1.  
Example: metric thread diameter 7 with a pitch of 1 mm = M7x1

## Thread Identification

BSP Thread	Code	NPT/NPTF Threads	Code
1/8"	10	1/16"	08
1/4"	13	1/8"	11
3/8"	17	1/4"	14
1/2"	21	3/8"	18
3/4"	27	1/2"	22
1"	34	3/4"	28
1 1/4"	42	1"	35
1 1/2"	49	1 1/4"	43
2"	48	1 1/2"	50
		2"	44

Metric Thread	Code	Metric Thread	Code	Metric Thread	Code
M3x0.5	09	M12x1.25	66	M22x1.5	82
M5x0.8	19	M12x1.5	67	M24x1.5	83
M6x1	52	M13x1.25	68	M27x1.5	85
M7x1	55	M14x1.25	70	M30x2	88
M8x1	56	M14x1.5	71	M33x1.5	90
M8x1.25	57	M16x1.25	74	M39x1.5	36
M10x1	60	M16x1.5	75	M42x1.5	37
M10x1.5	62	M18x1.5	78	M42x2	96
M12x1	65	M20x1.5	80	M48x2	98



# Principle and Advantages of Our Connection Systems

A very large number of technical solutions exist for connecting two pipes together. Leader in industrial connection systems, Parker Legris offers a very wide range of technologies and materials to cover all requirements.

## Push-In Fittings

Tube retention with gripping ring

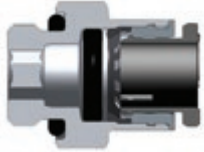

Tube retention with collet

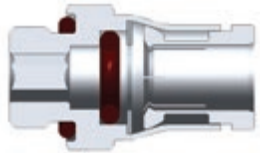

Tube retention with reversed collet

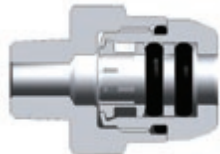

## Principle

Connected and sealed simply by pushing the tube into the fitting.  
Disconnected by pushing on the release button.

### Tube retention with gripping ring:

- No damage to the tube
- Ideal for polymer tubes
- Particularly compact

### Tube retention with collet:

- Robust solution for harsh environments
- Resistant to high pressure, excellent lifespan
- Ideal for grooved metal tubes

### Tube retention with reversed collet:

- Protected disconnection
- Can withstand very high pressures
- Double sealing

## Advantages

Allows flexible and modular systems to be produced quickly.

Provides a compact and lightweight connection solution.

Facilitates installation due to a swivelling body.

Reliability of the connection ensured through the one-piece design.

Suitable for use with a wide range of tubes.

Prolongs the lifespan of your systems.

## Compression Fittings



## Principle

Connection and sealing achieved by crimping a metal olive onto a tube.  
The seals are metal to metal.

## Advantages

Can withstand very high pressures and temperatures.

Allows all types of tube to be connected, both polymer and metal.

Increases the lifetime of the fitting.

## Spigot Compression Fittings



## Principle

Connection and sealing by the distortion and gripping of a plastic tube.

## Advantages

Intended for the connection of very flexible or non-calibrated tubes.

## Couplers

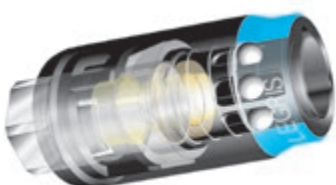

## Principle

A probe with an international profile connects the circuit to the coupler. Certain couplers have a safety device which enables the circuit to be vented before releasing the probe.

## Advantages

Suitable for frequent connection and disconnection.

# Product Selection Table

Push-In Fittings	Materials	Fluids	Maximum Pressure (bar)	Temperature		Performance in Aggressive Environments	
				Min.	Max.	Mechanical	Chemical
<b>LF 3000®</b>	Technical polymer/brass/NBR	Compressed air	20	-20°C	+80°C	Good	Moderate
<b>LF 3200</b>	Nickel-plated brass/NBR	Compressed air	20	-15°C	+80°C	Excellent	Moderate
<b>LIQUIfit®</b>	Bio-sourced polymer/nickel-plated brass FDA/316L stainless steel/EPDM	Liquids	16	-10°C	+95°C	Moderate	Good
<b>LF 6270, Optic Fibre</b>	Polycarbonate /NBR or silicone	Compressed air or water	25	-20°C*	+80°C	Excellent	Moderate
<b>Prestomatic 3</b>	Technical polymer/brass/NBR	Compressed air, air-brake systems	25	-50°C*	+100°C	Good	Moderate
<b>Prestomatic 2</b>	Brass/NBR	Compressed air, air brake systems	25	-50°C*	+100°C	Good	Moderate
<b>LF 3600</b>	Chemical nickel-plated brass FDA/FKM	All brass-compatible fluids	30	-25°C	+150°C	Excellent	Good
<b>LF 6100</b>	Brass/NBR	Oil, analytical gases	60	-40°C	+120°C	Excellent	Moderate
<b>LF 3800 / LF 3900</b>	316L - 303 stainless steel/FKM	All fluids	30	-25°C	+150°C	Excellent	Excellent

\*temperature must be lowered while circuit is under pressure

## Cartridges and Customised Products

<b>LF 3000®</b>	Technical polymer/brass or chemical nickel-plated brass/NBR	Compressed air	20	-20°C	+80°C	Good	Moderate
<b>LIQUIfit®</b>	Bio-sourced polymer/ brass or nickel-plated brass/EPDM	Liquids	16	-10°C	+95°C	Moderate	Good
<b>LF 3600</b>	Chemical nickel-plated brass FDA/FKM	All brass-compatible fluids	30	-20°C	+150°C	Excellent	Good
<b>LF 3800 / LF 3900</b>	316L - 303 stainless steel/FKM	All fluids	30	-20°C	+150°C	Excellent	Excellent
<b>FTL</b>	Brass/NBR	Compressed air	16	-25°C	+80°C	Good	Moderate

## Technical Tubing and Hose

<b>Semi-Rigid PA</b>	Semi-rigid bio-sourced polyamide	Compressed air, industrial fluids	50	-40°C	+100°C	Good	Good
<b>Rigid PA</b>	Rigid polyamide	Compressed air, industrial fluids	58	-40°C	+80°C	Good	Good
<b>Fireproof High Resistance PA</b>	Polyamide with flame-retardant additive	Coolants, industrial fluids (lubricants), compressed air	50	-50°C	+100°C	Excellent	Moderate
<b>Anti-Spark PA and PU with or without PVC sheath</b>	Semi-rigid polyamide with PVC sheath Polyurethane ether with PVC sheath Single-layer polyurethane ether with flame-retardant additive	Compressed air, coolants, industrial fluids	36 (PA) 14 (PU)	-20°C	+80°C +70°C	Excellent	Good
<b>PU single and multi-tube</b>	Polyurethane ester Polyurethane ether "Crystal" food-quality polyurethane ether	Compressed air, industrial fluids (water) or food industry fluids	12	-20°C	+70°C	Excellent	Moderate Good Good
<b>Antistatic PU</b>	Polyurethane filled with conductive particles	Compressed air	10	-20°C	+70°C	Excellent	Moderate
<b>Advanced PE</b>	Polyethylene, 50% reticulated	All fluids	16	-40°C	+95°C	Good	Excellent
<b>FEP</b>	Fluoropolymer: fluorinated ethylene-propylene	All fluids	28	-40°C	+150°C	Good	Excellent
<b>PFA</b>	Fluoropolymer: high purity and coloured perfluoroalkoxy FDA	All fluids	36	-196°C	+260°C	Excellent	Excellent
<b>Antistatic PFA</b>	Fluoropolymer: perfluoroalkoxy filled with conducting particles	All fluids	36	-196°C	+260°C	Excellent	Good
<b>Self-Fastening NBR</b>	NBR with polyamide braid	Compressed air, coolants	16	-20°C	+100°C	Excellent	Good
<b>Braided PU</b>	Polyurethane with polyester braid	Compressed air, industrial fluids	15	-40°C	+75°C	Excellent	Good

## Function Fittings

<b>Polymer Flow Regulators</b>	Technical polymer/nickel-plated brass	Compressed air	10	0°C	+70°C	Good	Moderate
<b>Metal Flow Regulators</b>	Treated brass/nickel-plated brass	Compressed air	10	-25°C*	+70°C	Excellent	Moderate

\*depending on the model

This table is not exhaustive; you will find additional technical information in the various chapters of this catalogue which will enable you to select the product you need.



Function Fittings (continued)	Materials	Fluids	Maximum Pressure (bar)	Temperature		Performance in Aggressive Environments	
				Min.	Max.	Mechanical	Chemical
<b>Stainless Steel Flow Regulators</b>	316L stainless steel	Compressed air	40	-15°C	+120°C	Excellent	Excellent
<b>Blocking Fittings</b>	Nickel-plated brass	Compressed air	10	-20°C	+70°C	Excellent	Good
<b>Piloted Non-Return Valve</b>	Technical polymer/nickel-plated brass	Compressed air	10	-5°C	+60°C	Good	Moderate
<b>Non-Return Fitting</b>	Technical polymer/nickel-plated brass	Compressed air	10	0°C	+70°C	Good	Moderate
<b>LIQUIFIT® Non-Return Fitting</b>	POM	Compressed air, drinkable water, treated water, beverages	10	0°C	+0°C	Good	Moderate
<b>Silencers</b>	Polymer, sintered bronze, nickel-plated brass, 316L stainless steel	Compressed air	12	-20°C	+180°C	Good	Moderate

\*depending on the model

## Compression Fittings

<b>Brass Fittings</b>	Brass	Compressed air, industrial fluids	550 (depending on the type of tubing used)	-60°C	+250°C	Excellent	Good
<b>Stainless Steel Fittings</b>	316L stainless steel	All fluids	400 (80 bar in aggressive environment)	-60°C	+250°C	Excellent	Excellent
<b>PL Spigot Fittings</b>	Nickel-plated brass	Compressed air, industrial fluids	40 (depending on the type of nut used)	-40°C	+100°C	Good	Good

## Industrial Valves

<b>Universal and Customised Series Ball Valves</b>	Nickel-plated brass	Compressed air, industrial fluids	40	-40°C*	+100°C	Excellent	Good
<b>Mini Series Ball Valves</b>	Technical polymer/nickel-plated brass	Compressed air	10	-20°C	+80°C	Good	Moderate
<b>DVGW Series Ball Valves</b>	Nickel-plated brass	Gas, water	40	-40°C	+170°C	Excellent	Good
<b>LIQUIFIT® Ball Valves</b>	Polypropylene	Drinking water, treated water, beverages	10	-15°C	+100°C	Moderate	Good
<b>Standard Series Ball Valves</b>	Nickel- or chromium-plated brass	All industrial fluids	30	-20°C	+130°C	Excellent	Good
<b>Stainless Steel Series Ball Valves</b>	316L stainless steel	All fluids	65	-20°C	+150°C	Excellent	Excellent
<b>Axial Valves</b>	Nickel-plated brass	Compressed air	10	-20°C	+135°C	Excellent	Good

\*depending on the model

## Industrial Blowguns

<b>Polymer</b>	Technical polymer	Compressed air	10	-20°C	+50°C	Good	Moderate
<b>Metal</b>	Aluminium or nickel-plated brass	Industrial fluids	20	-20°C	+100°C	Excellent	Good

## Quick-Acting Couplers

<b>C 9000 Safety Couplers</b>	Technical polymer	Compressed air	16	-20°C	+60°C	Good	Moderate
<b>Metal Quick-Acting Couplers</b>	Nickel-plated brass	Compressed air, compatible fluids	20	-20°C	+100°C	Excellent	Good
<b>Coupleurs séries mini, médium et maxi</b>	Nickel-plated brass	Water and air	20	-20°C	+100°C	Excellent	Good

## Adaptors and Manifolds

<b>Brass Adaptors with sealing washer</b>	Brass	Compressed air	200	-20°C	+100°C	Good	Moderate
<b>Brass Adaptors without sealing washer</b>	Brass	Compressed air	200	-40°C	+150°C	Good	Moderate
<b>Nickel-Plated Brass Adaptors</b>	Nickel-plated brass	Compressed air	60	-10°C	+80°C	Good	Moderate
<b>Stainless Steel Adaptors</b>	316L stainless steel	All fluids	200	-20°C	+180°C	Excellent	Excellent
<b>Manifolds</b>	Anodised aluminium, brass	Compressed air	20	-10°C	+80°C	Excellent	Good

# Part Number Identification

The part numbers used for our product ranges are coded in such a way as to make it easy to identify any particular item. Detailed explanations of these part numbers can be found in the corresponding chapters.

## Fittings and Valves

The part numbers are selected using a technical mnemonic code.

Each fitting and valve is identified by:

- model series (4 digits)
- nominal diameter (2 digits)

- thread or 2<sup>nd</sup> nominal diameter (2 digits)
- a suffix, if applicable

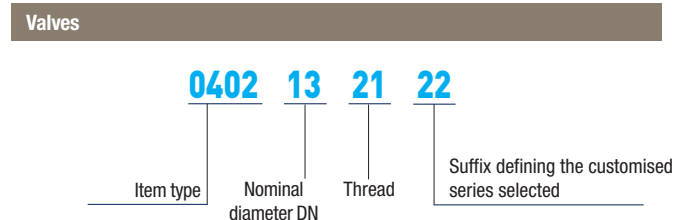
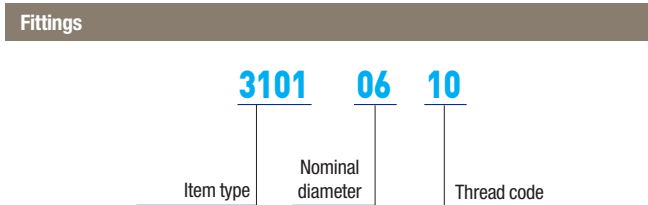

**Nominal diameter code:** equates to the outside diameter of the tube.  
**Thread code:** see tables page 12.

**Nominal diameter code:** equates to the bore diameter of the valve.  
**Thread code:** see tables page 12.

When the product does not have a thread, the code used is: 00.

## Technical Tubing and Hose

The part numbers are selected using a technical mnemonic code.

Each tube and hose is identified by:

- model series (4 digits and a letter)
- nominal diameter (2 digits)

- colour (2 digits)
- inside diameter, if applicable

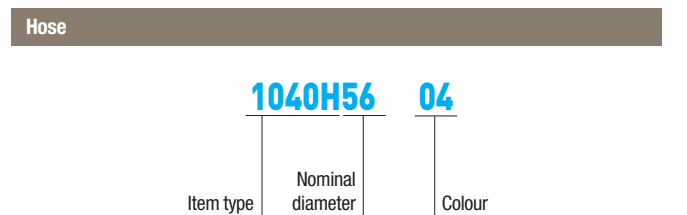
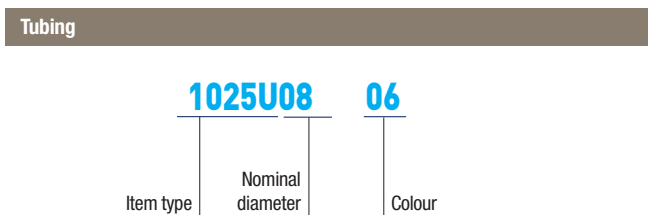

**Nominal diameter code:** equates to the outside diameter.  
**Colour code:** see table below.

**Nominal diameter code:** equates to the inside diameter code.  
**Colour code:** see table below.

00 = □    01 = ■    02 = ■    03 = ■    04 = ■    05 = ■    06 = ■    07 = ■    08 = □

For other colours, refer to chapter "Technical Tubing and Hose".

## Push-In Fittings

Chapter 1

LF 3000®/LF 3200  
LIQUIfit®  
LF 6270, Optic Fibre

Prestomatic  
LF 3600/LF 6100  
LF 3800/LF 3900



## Cartridges and Customised Products

Chapter 2

Polymer: Carstick® & Quick Fitting  
Metal: LF Cartridges & FTL Fittings  
Customised Products



## Technical Tubing and Hose

Chapter 3

Flexible Calibrated Tubing  
Calibrated Multi-Tubing  
Recoil Tubing and Hose

Calibrated Braided Hose  
Accessories



## Function Fittings

Chapter 4

Flow Control Regulators  
Piloted Function Fittings  
Non-Return Valves & LIQUIfit®

Pressure Fittings  
Other Function Fittings  
Silencers



## Compression Fittings

Chapter 5

Brass Compression Fittings  
Stainless Steel Compression Fittings  
PL Nickel-Plated Brass Spigot Fittings



## Industrial Valves

Chapter 6

Ball Valves & LIQUIfit®  
Needle & Butterfly Valves  
Axial Valves



## Industrial Blowguns

Chapter 7

Polymer  
Metal  
Kits



## Quick-Acting Couplers

Chapter 8

Polymer: C 9000 Safety  
Metal: Nickel-Plated Brass and Steel



## Adaptors and Manifolds

Chapter 9

Adaptors: Brass, Nickel-Plated Brass, Stainless Steel  
Manifolds



# Push-In Fittings

**LF 3000<sup>®</sup> and LF 3200**

**LIQUIfit<sup>®</sup>**

**LF 6270, Optic Fibre**

**Prestomatic**

**LF 3600 and LF 6100**

**LF 3800/LF 3900**





# Principle and Advantages of the Push-In Fitting

The **push-in fitting** is the most intuitive way of connecting tubes to a fitting in order to create a fluid distribution network. Thanks to its **quick installation**, versatility and **exceptional lifespan**, the push-in fitting contributes to improving machine efficiency. Moreover, the advanced patented design of the LF 3000® contributes to reducing **total cost of use**.

## Connection

- Manual connection and disconnection without the use of tools
- Release button available in 5 colours, to identify different circuits

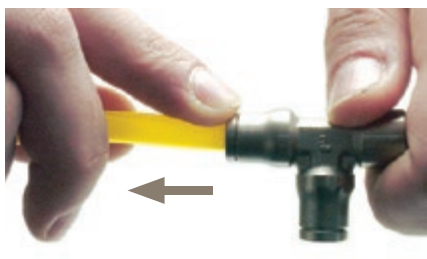
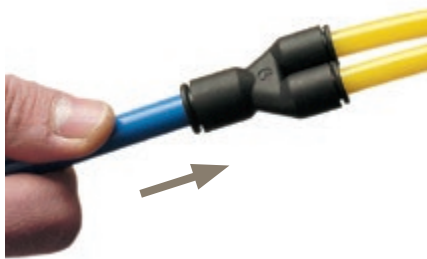

## Assembly

All straight connectors are fitted with an internal hexagon for ease of assembly with the use of an Allen spanner. This enables assembly in restricted spaces.

### Threads

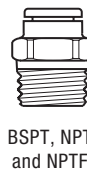

### Close Porting Assembly



Our fittings are designed for internal (above) or external assembly.

## Sealing and 100 % Leak-Tested

The quality of the sealing material, selected specifically for the application, ensures excellent longevity of the fitting. In this way, Parker Legris offers the best return on investment on the market.

### Quality of Design

- Unique and patented sealing technology
- Rigorous selection of materials:  
NBR: ideally suited for compressed air  
EPDM: perfectly suited for food and beverage  
FKM: all fluids and high temperatures
- 100 % leak-tested in the production process

### Benefits of Use

- The lowest leak rate on the market, whatever the temperature and length of use
- Perfectly suited to primary vacuum
- Full bore for optimum flow
- Optimum gripping of tube guaranteed

## Gripping Ring Technology

- Ideal for polymer tubing, even for soft tubing
- Excellent tube guidance
- No tube movement under pressure
- Very compact solution

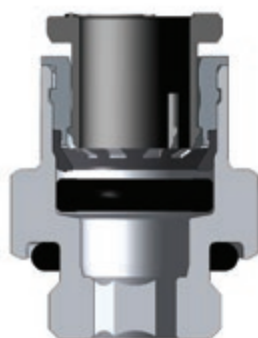

## Gripping with Collet

- For polymer and grooved metal tubing (groove drawings available on request)
- Resistant to high pressure, excellent lifespan
- Robust solution for harsh environments

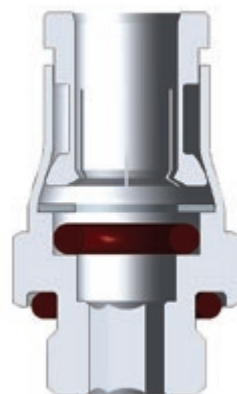

## Gripping with Reversed Collet

- For rigid polymer and grooved metal tubing
- Resistant to high pressure
- Excellent durability
- Optimum sealing

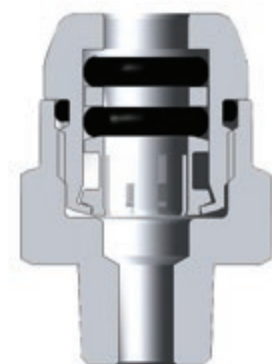

# Push-In Fittings

## LF 3000® Push-In Fittings

(P. 1-4)



**Fluids:** compressed air

**Materials:** technical polymer, nickel-plated brass, NBR

**Pressure:** 20 bar

**Temperature:** -20°C to +80°C

**Ø metric:** 3 mm to 16 mm

**Ø inch:** 1/8" to 1/2"

## LF 3200 Push-In Fittings (3 mm)

(P. 1-39)



**Fluids:** compressed air, non-corrosive fluids

**Materials:** chemical nickel-plated brass, NBR

**Pressure:** 20 bar

**Temperature:** -15°C to +80°C

**Ø metric:** 3 mm

## LIQUIfit® Push-In Fittings

(P. 1-44)



**Fluids:** water, beverages, coolants, inert gases

**Materials:** biopolymer, EPDM, nickel-plated brass or stainless steel

**Pressure:** 16 bar

**Temperature:** -10°C to +95°C

**Ø metric:** 4 mm to 12 mm

**Ø inch:** 5/32" to 1/2"

## LF 6270 Connectors for Optic Fibre Networks

(P. 1-73)



**Fluids:** compressed air, industrial water

**Materials:** technical polymer, NBR

**Pressure:** 25 bar

**Temperature:** -20°C to +80°C

**Ø metric:** 5 mm to 14 mm

## Prestomatic Push-In Fittings

(P. 1-83)



**Fluids:** compressed air

**Materials:** technical polymer, brass, NBR

**Pressure:** 25 bar

**Temperature:** -50°C to +100°C

**Ø metric:** 6 mm to 16 mm

## Braking System Adaptors

(P. 1-90)



**Fluids:** compressed air

**Materials:** brass, NBR

**Pressure:** 25 bar

**Temperature:** -40°C to +100°C

## LF 3600 Push-In Fittings

(P. 1-95)



**Fluids:** compressed air, slightly corrosive industrial fluids

**Materials:** high phosphorus nickel-plated brass, FKM

**Pressure:** 30 bar

**Temperature:** -25°C to +150°C

**Ø metric:** 4 mm to 14 mm

## LF 6100 Push-In Fittings

(P. 1-107)



**Fluids:** compressed air, oil, water

**Materials:** brass, NBR

**Pressure:** 60 bar

**Temperature:** -40°C to +120°C

**Ø metric:** 4 mm to 10 mm

## LF 3800/LF 3900 Push-In Fittings

(P. 1-113)



**Fluids:** industrial fluids, chemicals, medical fluids, beverages

**Materials:** stainless steel, FKM

**Pressure:** 30 bar

**Temperature:** -25°C to +150°C

**Ø metric:** 4 mm to 12 mm

**Ø inch:** 3/16" to 1/2"

For more details on these ranges, you will find a selection guide in the "Introduction" section of this catalogue.



# LF 3000® Push-In Fittings Range

## Stud Fittings

### Straights

**3175**  
BSPT/NPT  
Page 1-7



**3101**  
BSPP/Metric  
Page 1-8



**3181**  
Metric  
Page 1-8



**3114**  
BSPP/Metric  
Page 1-9



**3121**  
BSPT/NPT  
Page 1-9



**3131**  
BSPP/Metric  
Page 1-10



### Straights - Inch

**3175**  
NPT/BSPT  
Page 1-7/8



**3121**  
NPT  
Page 1-9



### Elbows

**3109**  
BSPT/NPT  
Page 1-10



**3199**  
BSPP/Metric  
Page 1-11



**3192**  
BSPP  
Page 1-12



**3129**  
BSPT  
Page 1-12



**3169**  
BSPP/Metric  
Page 1-13



**3113**  
BSPT  
Page 1-13



**3133**  
BSPP/Metric  
Page 1-13



### Elbows - Inch

**3109**  
NPT/BSPT  
Page 1-11



### Tees

**3108**  
BSPT  
Page 1-14



**3198**  
BSPP/Metric  
Page 1-14



**3103**  
BSPT  
Page 1-14



**3193**  
BSPP/Metric  
Page 1-15



### Y

**3148**  
BSPT  
Page 1-15



**3158**  
BSPP/Metric  
Page 1-15



**3112**  
BSPT  
Page 1-16



**3132**  
BSPP  
Page 1-16



### Cartridge

**3100**  
Carstick®  
Page 1-16



### Cartridge - Inch

**3100**  
Carstick®  
Page 1-16



## Tube-to-Tube Fittings

### Straight

**3106**  
Page 1-17



### Straight - Inch

**3106**  
Page 1-17



### Elbow

**3102**  
Page 1-17



### Elbow - Inch

**3102**  
Page 1-17



### Tee

**3104**  
Page 1-18



### Tee - Inch

**3104**  
Page 1-18



### Y

**3140**  
Page 1-18



### Cross

**3107**  
Page 1-19



## Bulkhead Connector Fittings

### Straights

**3116**  
Page 1-20



**3146**  
Page 1-20



**3136**  
Page 1-20



### Elbow

**3139**  
Page 1-20



## Multiple Fittings

### Y

**3144**  
Page 1-21



### Tee

**3304**  
Page 1-21



### Elbow

**3306**  
Page 1-21



### Manifold

**3310**  
Page 1-21





# LF 3000® Push-In Fittings Range

## Plug-In Fittings and Accessories

Elbows			Elbows - Inch		Tees		Y	
<b>3182</b> Page 1-22	<b>3184</b> Page 1-22	<b>3180</b> Page 1-22	<b>3182</b> Page 1-22		<b>3183</b> Page 1-23	<b>3188</b> Page 1-23	<b>3142</b> Page 1-23	<b>3143</b> Page 1-23
								
Accessories					Accessories - Inch			
<b>3120</b> Page 1-24	<b>3166</b> Page 1-24	<b>3168</b> Page 1-24	<b>3126</b> Page 1-25	<b>3122</b> Page 1-25	<b>3151</b> Page 1-25	<b>3166</b> Page 1-24	<b>3168</b> Page 1-24	<b>3126</b> Page 1-25
								



## Banjo Fittings

Banjo Fittings						
<b>3118</b> BSPP/Metric Page 1-27	<b>3018</b> BSPT Page 1-27	<b>3124</b> BSPP/Metric Page 1-27	<b>3149</b> BSPP/Metric Page 1-27	<b>3119</b> BSPP/Metric Page 1-27		
						
Modular Banjo Fittings						
<b>3538</b> Single Body Page 1-28	<b>3539</b> Double Body Page 1-28	<b>3549</b> Y Body Page 1-28	<b>3527</b> BSPP/Metric Page 1-29	<b>3528</b> BSPP/Metric Page 1-29	<b>3529</b> BSPP Page 1-29	<b>3524</b> BSPP/Metric Page 1-29
						

## Multi-Connectors

<b>3300</b> Page 1-31	<b>3320</b> Page 1-31	<b>3321</b> Page 1-31	<b>3329</b> Page 1-31	<b>3379</b> Page 1-32	<b>3381</b> Page 1-32
					

## Self-Sealing and Oscillating Fittings

Self-Sealing Fittings			Oscillating Fittings	
<b>3391</b> BSPP Page 1-35	<b>3091</b> BSPT Page 1-35	<b>3160</b> Page 1-35	<b>3159</b> BSPT Page 1-35	<b>3189</b> BSPP/Metric Page 1-35
				

## Accessories for Push-In Fittings

<b>3130</b> Page 1-37	<b>Clip</b> Page 1-37	<b>3000 70</b> Page 1-37	<b>3110</b> Page 1-37	<b>0178</b> BSPP/Metric Page 1-37	<b>0222</b> BSPP/Metric Page 1-37
					

# LF 3000® Push-In Fittings

The LF 3000® range, with its wide variety of shapes and configurations, allows you to find **the perfect product to meet your needs** and thus **optimise the use** of your equipment.

## Product Advantages

### Extreme Durability for Optimum Profitability

40 years of expertise  
 Conforms to ISO 14743  
 Ideal for vacuum or pressure applications  
 Tried-and-tested longevity according to DI 2006/42/CE requirements  
 Materials with high resistance  
 Durability of product and equipment

### Maximum Machine Efficiency

100% leak-tested in production  
 Full bore for optimum flow  
 Tube fixed during connection, preventing leakage  
 Excellent vacuum performance thanks to the patented sealing technology

### Productivity & Maintenance Improvement

Compact and aesthetic design: reduced dimensions for space-saving  
 Lightweight: reduced energy consumption of operating systems  
 Parallel threaded fitting with a patented captive O-ring seal  
 Maximum flexibility due to the wide product range  
 Date coding to guarantee quality and traceability  
 Automatic sealing guaranteed, in both static and dynamic applications



Robotics  
 Automotive Process  
 Pneumatics  
 Semi-Conductors  
 Textile  
 Packaging  
 Vacuum

Applications

## Technical Characteristics

<b>Compatible Fluids</b>	Compressed air Other fluids: please consult us
<b>Working Pressure</b>	Vacuum to 20 bar
<b>Working Temperature</b>	-20°C to +80°C

Tightening Torque (daN.m)	Threads								
	M3 x0.5	M5 x0.8	M7 x1	M10 x1	M12 x1.5	G1/8	G1/4	G3/8	G1/2
	0.06	0.16	0.8	0.8	1.1	0.8	1.2	3	3.5

Reliable performance is dependent upon the type of fluid conveyed, component materials and tubing being used.  
 Use is guaranteed with a vacuum of 755 mm Hg (99% vacuum).

### Component Materials

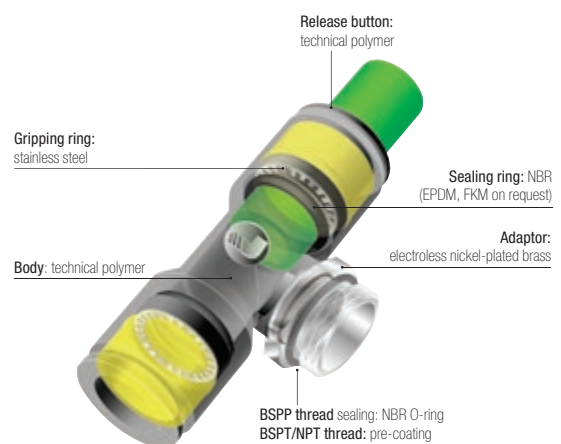

### Silicone-free

### Regulations

DI: 2006/42/EC test according to ISO 19973-5.  
 ISO 14743: Pneumatic fluid power, push-in connectors for thermoplastic tubes

DI: 97/23/EC (PED)  
 DI: 2002/95/EC (RoHS), 2011/65/EC  
 DI: 1907/2006 (REACH)

# Stud Fittings

## 3175 Stud Fitting, Male BSPT Thread

Nickel-plated brass, NBR

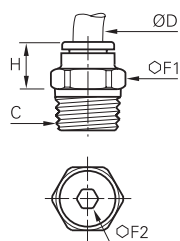

ØD	C		F1	F2	H	Kg
4	R1/8	<a href="#">3175 04 10</a>	10	3	9.5	0.005
	R1/4	<a href="#">3175 04 13</a>	14	3	6.5	0.012
	R3/8	<a href="#">3175 04 17</a>	17	3	8	0.024
6	R1/8	<a href="#">3175 06 10</a>	10	4	11.5	0.005
	R1/4	<a href="#">3175 06 13</a>	14	4	8.5	0.011
	R3/8	<a href="#">3175 06 17</a>	17	4	8.5	0.022
8	R1/2	<a href="#">3175 06 21</a>	21	4	9	0.043
	R1/8	<a href="#">3175 08 10</a>	13	5	20	0.011
	R1/4	<a href="#">3175 08 13</a>	14	6	17	0.014
	R3/8	<a href="#">3175 08 17</a>	17	6	13	0.021
10	R1/2	<a href="#">3175 08 21</a>	21	6	12	0.040
	R1/8	<a href="#">3175 10 10</a>	16	5	22.5	0.017
	R1/4	<a href="#">3175 10 13</a>	16	7	20	0.017
	R3/8	<a href="#">3175 10 17</a>	17	8	16.5	0.019
12	R1/2	<a href="#">3175 10 21</a>	21	8	14	0.036
	R1/4	<a href="#">3175 12 13</a>	19	7	26.5	0.029
	R3/8	<a href="#">3175 12 17</a>	19	9	24	0.028
14	R1/2	<a href="#">3175 12 21</a>	21	10	19.5	0.036
	R3/8	<a href="#">3175 14 17</a>	22	9	28.5	0.044
16	R1/2	<a href="#">3175 14 21</a>	24	10	23.5	0.047
	R3/8	<a href="#">3175 16 17</a>	27	9	32.5	0.068
	R1/2	<a href="#">3175 16 21</a>	27	12	32.5	0.079

Pre-coated thread

## 3175 Stud Fitting, Male NPT Thread

Nickel-plated brass, NBR

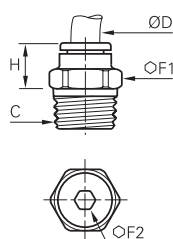

ØD	C		F1	F2	H	Kg
6	NPT1/8	<a href="#">3175 06 11</a>	11	4	11.5	0.006
	NPT1/4	<a href="#">3175 06 14</a>	14	4	8.5	0.013
10	NPT1/4	<a href="#">3175 10 14</a>	16	7	20	0.018
	NPT3/8	<a href="#">3175 10 18</a>	18	8	16.5	0.023
12	NPT1/2	<a href="#">3175 10 22</a>	22	8	14	0.037
	NPT3/8	<a href="#">3175 12 18</a>	19	9	24	0.030
	NPT1/2	<a href="#">3175 12 22</a>	22	10	19.5	0.037

Pre-coated thread

## 3175 Stud Fitting, Male NPT Thread

Inch

Nickel-plated brass, NBR

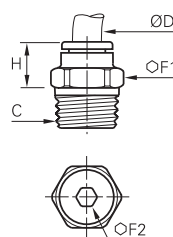

ØD	C		F1	F2	H	Kg
1/8	NPT1/8	<a href="#">3175 53 11</a>	11	2	7.2	0.006
	NPT1/4	<a href="#">3175 53 14</a>	14	2	8	0.015
1/4	NPT1/8	<a href="#">3175 56 11</a>	11	4	11.9	0.006
	NPT1/4	<a href="#">3175 56 14</a>	14	4	9.4	0.013
	NPT3/8	<a href="#">3175 56 18</a>	18	5	7.6	0.024
3/8	NPT1/8	<a href="#">3175 60 11</a>	16	4	22.7	0.019
	NPT1/4	<a href="#">3175 60 14</a>	16	7	20.5	0.019
1/2	NPT3/8	<a href="#">3175 60 18</a>	18	7	17.5	0.026
	NPT3/8	<a href="#">3175 62 18</a>	22	9.5	25.9	0.047
	NPT1/2	<a href="#">3175 62 22</a>	24	9.5	22.1	0.064

Pre-coated thread

Other products are available upon request; please do not hesitate to consult us.

# Stud Fittings

## 3175 Stud Fitting, Male BSPT Thread

Inch

Nickel-plated brass, NBR

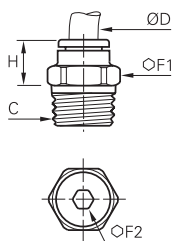

ØD	C		F1	F2	H	Kg
1/8	R1/8	3175 53 10	11	3	8.5	0.005
	R1/8	3175 55 10	11.1	3.2	15.5	0.009
3/16	R1/4	3175 55 13	14.3	4	15	0.020
	R1/8	3175 56 10	11	4	12	0.006
1/4	R1/4	3175 56 13	14	4	9.5	0.021
	R1/4	3175 60 13	18	5	7.5	0.018
3/8	R3/8	3175 60 17	13	5	20	0.019
	R1/2	3175 60 21	14	6	16.8	0.061
1/2	R1/4	3175 62 13	22	6	26.9	0.044
	R3/8	3175 62 17	22	7	25.9	0.048
	R1/2	3175 62 21	24	7	20.5	0.049

Pre-coated thread

## 3101 Stud Fitting, Male BSPP and Metric Thread

Nickel-plated brass, NBR

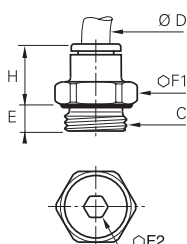

ØD	C		E	F1	F2	H	Kg
3	M3x0.5	3101 03 09*	2.5	8	-	12.5	0.003
	M5x0.8	3101 03 19	3.5	8	2.5	12.5	0.004
	M3x0.5	3101 04 09*	2.5	8	-	14.5	0.003
	M5x0.8	3101 04 19	3	9	2.5	14	0.004
4	M7x1	3101 04 55	5	10	2.5	14	0.004
	G1/8	3101 04 10	5	13	3	11.5	0.007
	G1/4	3101 04 13	5.5	16	3	10.5	0.011
	M5x0.8	3101 06 19	3.5	11	2.5	16	0.005
	M7x1	3101 06 55	5	10	3	16	0.006
	M10x1	3101 06 60	5	13	4	13	0.007
6	M12x1.5	3101 06 67	5.5	15	4	13	0.009
	G1/8	3101 06 10	5	13	4	13	0.007
	G1/4	3101 06 13	5.5	16	4	12.5	0.010
	G3/8	3101 06 17	5.5	20	4	13	0.020
	G1/2	3101 06 21	7.5	24	4	20	0.040
	M10x1	3101 08 60	5	13	5	21	0.011
8	M12x1.5	3101 08 67	5.5	15	5	21	0.015
	G1/8	3101 08 10	4.5	13	5	20.5	0.011
	G1/4	3101 08 13	5.5	16	6	19.5	0.016
	G3/8	3101 08 17	5.5	20	6	18	0.022
	G1/2	3101 08 21	7.5	24	6	16.5	0.039
	G1/4	3101 10 13	5.5	16	7	23	0.018
10	G3/8	3101 10 17	5.5	20	8	19.5	0.021
	G1/2	3101 10 21	7.5	24	8	18.5	0.033
12	G1/4	3101 12 13	5.5	19	7	27.5	0.027
	G3/8	3101 12 17	5.5	20	9	27	0.029
14	G1/2	3101 12 21	7	24	11	22.5	0.035
	G3/8	3101 14 17	5.5	22	9	29.5	0.041
16	G1/2	3101 14 21	7	24	11	28	0.046
	G3/8	3101 16 17	7.5	27	9	32.5	0.061
	G1/2	3101 16 21	9	27	12	32.5	0.066

\*Bi-material O ring seal

## 3181 Stud Fitting Round Body, Male Metric Thread

Nickel-plated brass, NBR

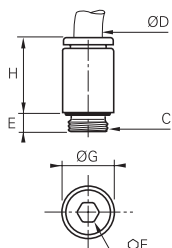

ØD	C		E	F	G	H	Kg
4	M5x0.8	3181 04 19	3.5	2.5	8.5	14.5	0.003
	M7x1	3181 04 55	5	3	10	14	0.004
6	M5x0.8	3181 06 19	3.5	2.5	11	16.5	0.005
	M7x1	3181 06 55	5	3	10	16	0.005

The internal hexagon and circular external shape ensure that model 3181 provides highly compact assembly.

They can be easily installed with an Allen key without the need of a spanner.

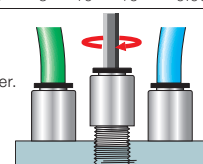

# Stud Fittings

## 3114 Stud Fitting, Female BSPP and Metric Thread

Nickel-plated brass, NBR

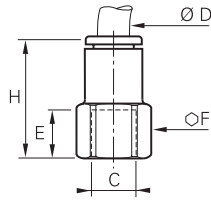

ØD	C		E	F	H	Kg
4	M5x0.8	<a href="#">3114 04 19</a>	6.5	8	19.5	0.005
	G1/8	<a href="#">3114 04 10</a>	9.5	13	22.5	0.009
	G1/4	<a href="#">3114 04 13</a>	13.5	16	26.5	0.015
6	G1/8	<a href="#">3114 06 10</a>	9.5	13	24.5	0.011
	G1/4	<a href="#">3114 06 13</a>	13.5	16	28.5	0.016
	G1/8	<a href="#">3114 08 10</a>	9.5	13	29	0.015
8	G1/4	<a href="#">3114 08 13</a>	13.5	16	33	0.021
	G3/8	<a href="#">3114 08 17</a>	14	19	34	0.025
	G1/4	<a href="#">3114 10 13</a>	13.5	16	36	0.027
10	G3/8	<a href="#">3114 10 17</a>	14	19	36	0.027
	G1/2	<a href="#">3114 10 21</a>	19.5	24	41.5	0.048
12	G3/8	<a href="#">3114 12 17</a>	14	19	40	0.033
	G1/2	<a href="#">3114 12 21</a>	19.5	24	45.5	0.053
14	G3/8	<a href="#">3114 14 17</a>	14	22	42.5	0.057
16	G1/2	<a href="#">3114 16 21</a>	15	27	49	0.096

## 3121 Stud Standpipe, Male BSPT Thread

Technical polymer, nickel-plated brass

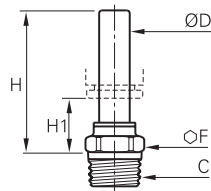

ØD	C		F	H	H1	Kg
4	R1/8	<a href="#">3121 04 10</a>	10	26	14	0.005
	R1/4	<a href="#">3121 04 13</a>	14	26.5	14.5	0.014
6	R1/8	<a href="#">3121 06 10</a>	10	28	14	0.005
	R1/4	<a href="#">3121 06 13</a>	14	28.5	14.5	0.014
8	R1/8	<a href="#">3121 08 10</a>	10	29.5	11	0.005
	R1/4	<a href="#">3121 08 13</a>	14	28.5	10	0.012
	R3/8	<a href="#">3121 08 17</a>	17	28.5	10	0.016
10	R1/4	<a href="#">3121 10 13</a>	15	36	15.5	0.012
	R3/8	<a href="#">3121 10 17</a>	17	36	15.5	0.017
	R1/2	<a href="#">3121 10 21</a>	21	36	15.5	0.028
12	R3/8	<a href="#">3121 12 17</a>	17	36.5	12	0.018
	R1/2	<a href="#">3121 12 21</a>	21	36.5	12	0.030
14	R1/2	<a href="#">3121 14 21</a>	21	41	13.5	0.042

Pre-coated thread

## 3121 Stud Standpipe, Male NPT Thread

Technical polymer, nickel-plated brass

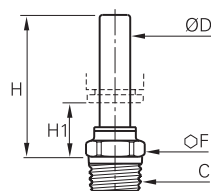

ØD	C		F	H	H1	Kg
4	NPT1/8	<a href="#">3121 04 11</a>	11	25.9	14.5	0.007
	NPT1/4	<a href="#">3121 04 14</a>	14	26.4	15	0.017
8	NPT1/8	<a href="#">3121 08 11</a>	11	29.5	10.9	0.008
	NPT1/4	<a href="#">3121 08 14</a>	14	28.4	9.9	0.014

Pre-coated thread

## 3121 Stud Standpipe, Male NPT Thread

Inch

Technical polymer, nickel-plated brass

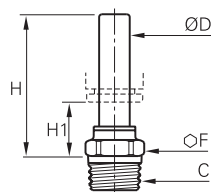

ØD	C		F	H	H1	Kg
1/4	NPT1/8	<a href="#">3121 56 11</a>	11	30	15.5	0.001
	NPT1/4	<a href="#">3121 56 14</a>	14	28.4	14.5	0.001
3/8	NPT1/8	<a href="#">3121 60 11</a>	15	44.4	16.5	0.013
	NPT1/4	<a href="#">3121 60 14</a>	15	36.1	17	0.014
1/2	NPT3/8	<a href="#">3121 60 18</a>	18	36.1	15.5	0.023
	NPT3/8	<a href="#">3121 62 18</a>	17	36.6	9.4	0.026
	NPT1/2	<a href="#">3121 62 22</a>	21	37.1	9.9	0.046

Pre-coated

5/32" (4 mm) and 5/16" (8 mm) are also available.

# Stud Fittings

## 3131 Stud Standpipe, Male BSPP and Metric Thread

Technical polymer, nickel-plated brass, NBR

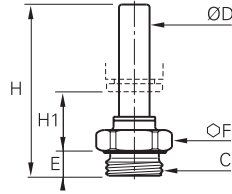

ØD	C		E	F	H	H1	Kg
4	M5x0.8	<a href="#">3131 04 19</a>	3.5	8	31	16	0.002
	G1/8	<a href="#">3131 04 10</a>	5	13	30	13.5	0.005
	G1/4	<a href="#">3131 04 13</a>	5.5	16	31	13.5	0.010
6	G1/8	<a href="#">3131 06 10</a>	5	13	32	13.5	0.005
	G1/4	<a href="#">3131 06 13</a>	5.5	16	33	13.5	0.010
	G1/8	<a href="#">3131 08 10</a>	5	13	35.5	12.5	0.008
8	G1/4	<a href="#">3131 08 13</a>	5.5	16	34.5	10.5	0.010
	G3/8	<a href="#">3131 08 17</a>	5.5	20	34.5	10.5	0.015
	G1/4	<a href="#">3131 10 13</a>	5.5	16	43.5	17.5	0.012
10	G3/8	<a href="#">3131 10 17</a>	5.5	20	41.5	15.5	0.015
	G1/2	<a href="#">3131 10 21</a>	7.5	24	41.5	15.5	0.024
12	G3/8	<a href="#">3131 12 17</a>	5.5	20	42	12	0.015
	G1/2	<a href="#">3131 12 21</a>	7	24	43.5	12	0.025
14	G3/8	<a href="#">3131 14 17</a>	5.5	20	46.5	14	0.015
	G1/2	<a href="#">3131 14 21</a>	7	24	48	13.5	0.025

## 3109 Stud Elbow, Male BSPT Thread

Technical polymer, nickel-plated brass, NBR

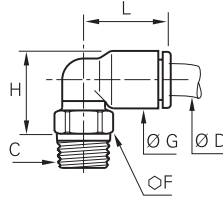

ØD	C		F	G	H	L	Kg
4	R1/8	<a href="#">3109 04 10</a>	10	8.5	13.5	14	0.006
	R1/4	<a href="#">3109 04 13</a>	14	8.5	14	14	0.015
	R3/8	<a href="#">3109 04 17</a>	17	8.5	13.5	14	0.018
6	R1/8	<a href="#">3109 06 10</a>	10	10.5	15.5	16	0.006
	R1/4	<a href="#">3109 06 13</a>	14	10.5	16	16	0.015
	R3/8	<a href="#">3109 06 17</a>	17	10.5	16	16	0.019
8	R1/2	<a href="#">3109 06 21</a>	21	10.5	16.5	16	0.034
	R1/8	<a href="#">3109 08 10</a>	10	13.5	19	23	0.007
	R1/4	<a href="#">3109 08 13</a>	14	13.5	18	23	0.014
10	R3/8	<a href="#">3109 08 17</a>	17	13.5	18	23	0.018
	R1/2	<a href="#">3109 08 21</a>	21	13.5	19.5	23	0.032
	R1/8	<a href="#">3109 10 10</a>	15	16	23	26.5	0.012
12	R1/4	<a href="#">3109 10 13</a>	15	16	22	26.5	0.014
	R3/8	<a href="#">3109 10 17</a>	17	16	22	26.5	0.020
	R1/2	<a href="#">3109 10 21</a>	21	16	22	26.5	0.032
14	R1/4	<a href="#">3109 12 13</a>	15	19	25	31	0.016
	R3/8	<a href="#">3109 12 17</a>	17	19	25	31	0.022
	R1/2	<a href="#">3109 12 21</a>	21	19	25	31	0.035
16	R3/8	<a href="#">3109 14 17</a>	20	22	30.5	35.5	0.031
	R1/2	<a href="#">3109 14 21</a>	24	22	28.5	35.5	0.041
	R3/8	<a href="#">3109 16 17</a>	27	27	53	39	0.106
	R1/2	<a href="#">3109 16 21</a>	27	27	53	39	0.104

Pre-coated thread  
The body swivels for positioning purposes.

## 3109 Stud Elbow, Male NPT Thread

Technical polymer, nickel-plated brass, NBR

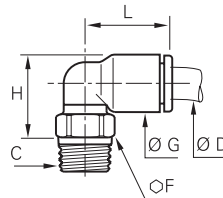

ØD	C		F	G	H	L	Kg
4	NPT1/8	<a href="#">3109 04 11</a>	11	8.4	13.5	14	0.007
	NPT1/4	<a href="#">3109 04 14</a>	14	8.4	14	14	0.016
6	NPT1/8	<a href="#">3109 06 11</a>	11	10.5	15.5	16	0.007
	NPT1/4	<a href="#">3109 06 14</a>	14	10.5	16	16	0.016
8	NPT1/8	<a href="#">3109 08 11</a>	11	13.5	19	23.1	0.009
	NPT1/4	<a href="#">3109 08 14</a>	14	13.5	18	23.1	0.015
	NPT1/4	<a href="#">3109 10 14</a>	15	16	23	26.5	0.017
10	NPT3/8	<a href="#">3109 10 18</a>	18	16	22	26.5	0.023
	NPT1/2	<a href="#">3109 10 22</a>	22	16	23	26.5	0.045
12	NPT3/8	<a href="#">3109 12 18</a>	18	19	25	31	0.027
	NPT1/2	<a href="#">3109 12 22</a>	22	19	26	31	0.033

Pre-coated thread  
The body swivels for positioning purposes.

# Stud Fittings

## 3109 Stud Elbow, Male NPT Thread

Inch

Technical polymer, nickel-plated brass, NBR

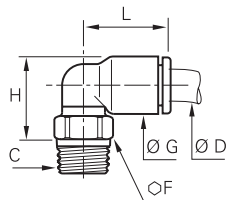

ØD	C		F	G	H	L	Kg
1/8	NPT1/8	3109 53 11	11	8.5	13.5	14.5	0.007
	NPT1/4	3109 53 14	14	8.5	14	14.5	0.015
1/4	NPT1/8	3109 56 11	11	10.9	17	18	0.008
	NPT1/4	3109 56 14	14	10.9	16	18	0.014
	NPT3/8	3109 56 18	18	10.9	16.5	18	0.020
3/8	NPT1/8	3109 60 11	15	16	23.1	27.4	0.013
	NPT1/4	3109 60 14	15	16	23.1	27.4	0.017
1/2	NPT3/8	3109 62 18	18	16	22.1	27.4	0.024
	NPT1/2	3109 62 22	20	22.1	31	35.1	0.033
			24	22.1	28.4	35.1	0.045

Pre-coated thread. The body swivels for positioning purposes.  
5/32"(4 mm) and 5/16"(8 mm) are also available.

## 3109 Stud Elbow, Male BSPT Thread

Inch

Technical polymer, nickel-plated brass, NBR

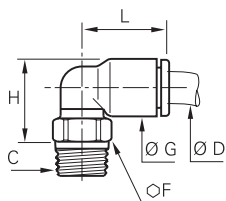

ØD	C		F	G	H	L	Kg
1/8	R1/8	3109 53 10	10	8.5	13.5	14.5	0.011
3/16	R1/8	3109 55 10	11	10.9	17	21.6	0.010
	R1/4	3109 55 13	14	8.4	14	14	0.016
1/4	R1/8	3109 56 10	10	10.9	17	18	0.006
	R1/4	3109 56 13	14	10.9	17	18	0.013
3/8	R1/4	3109 60 13	15	16	22.1	26.4	0.016
	R3/8	3109 60 17	17	16	22.1	26.4	0.054
	R1/4	3109 62 13	20	22.1	31	35.1	0.064
1/2	R3/8	3109 62 17	20	22.1	31	35.1	0.067
	R1/2	3109 62 21	24	22.1	28.4	35.1	0.046

Pre-coated thread. The body swivels for positioning purposes.  
5/32"(4 mm) and 5/16"(8 mm) are also available.

## 3199 Stud Elbow, Male BSPP and Metric Thread

Technical polymer, nickel-plated brass, NBR

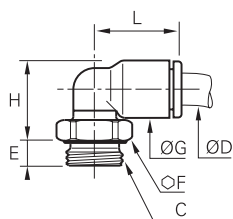

ØD	C		E	F	G	H	L	Kg
3	M3x0.5	3199 03 09	2.5	8	8.5	15	14.5	0.003
	M5x0.8	3199 03 19	3.5	8	8.5	13.5	14.5	0.003
	M3x0.5	3199 04 09*	2.5	8	8.5	15	14.5	0.002
	M5x0.8	3199 04 19	3.5	8	8.5	13.5	14	0.002
4	M7x1	3199 04 55	4.5	10	8.5	15	14	0.005
	G1/8	3199 04 10	5	13	8.5	13	14	0.006
	G1/4	3199 04 13	5.5	16	8.5	13	14	0.011
	M5x0.8	3199 06 19	3.5	8	10.5	15.5	16	0.003
	M7x1	3199 06 55	4.5	10	10.5	17.5	16	0.006
	M10x1	3199 06 60	5	13	10.5	15	14	0.006
6	M12x1.5	3199 06 67	5.5	15	10.5	15	16	0.009
	G1/8	3199 06 10	5	13	10.5	15	16	0.006
	G1/4	3199 06 13	5.5	16	10.5	15	16	0.011
	G3/8	3199 06 17	5.5	20	10.5	15.5	16	0.022
	G1/2	3199 06 21	7	24	10.5	16	16	0.028
	M10x1	3199 08 60	5	13	13.5	20.5	23	0.009
8	M12x1.5	3199 08 67	5.5	15	13.5	19.5	23	0.009
	G1/8	3199 08 10	4.5	13	13.5	20.5	23	0.009
	G1/4	3199 08 13	5.5	16	13.5	18.5	23	0.012
	G3/8	3199 08 17	5.5	20	13.5	18.5	23	0.017
	G1/2	3199 08 21	7	24	13.5	19	23	0.027
	G1/4	3199 10 13	5.5	16	16	23.5	26.5	0.014
10	G3/8	3199 10 17	5.5	20	16	22	26.5	0.017
	G1/2	3199 10 21	7.5	24	16	22	26.5	0.027
	G1/4	3199 12 13	5.5	16	19	26.5	31	0.016
12	G3/8	3199 12 17	5.5	20	19	25	31	0.019
	G1/2	3199 12 21	7	24	19	25	31	0.029
14	G3/8	3199 14 17	5.5	20	22	32.5	35.5	0.029
	G1/2	3199 14 21	7	24	22	27	35.5	0.028
16	G3/8	3199 16 17	7.5	27	27	54.5	39	0.101
	G1/2	3199 16 21	9	27	27	54.5	39	0.097

The body swivels for positioning purposes.  
\*Bi-material seal

# Stud Fittings

## 3192 Stud Elbow, Female BSPP Thread

Technical polymer, nickel-plated brass, NBR

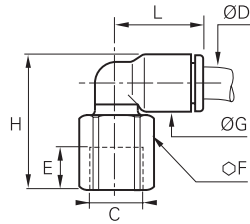

ØD	C		E	F	G	H	L	Kg
4	G1/8	<a href="#">3192 04 10</a>	8.5	13	8.5	23	14	0.010
	G1/4	<a href="#">3192 04 13</a>	11.5	16	8.5	27	14	0.017
6	G1/8	<a href="#">3192 06 10</a>	8.5	13	10.5	25	16	0.010
	G1/4	<a href="#">3192 06 13</a>	11.5	16	10.5	29	16	0.017
8	G1/8	<a href="#">3192 08 10</a>	8.5	13	13.5	28	23	0.012
	G1/4	<a href="#">3192 08 13</a>	11.5	16	13.5	32	23	0.020
	G3/8	<a href="#">3192 08 17</a>	12	19	13.5	33	23	0.026
10	G1/4	<a href="#">3192 10 13</a>	11	16	16	34.5	26.5	0.020
	G3/8	<a href="#">3192 10 17</a>	12	19	16	35	26.5	0.024
	G1/2	<a href="#">3192 10 21</a>	16	24	16	41	26.5	0.048
12	G1/4	<a href="#">3192 12 13</a>	11	16	19	38	30.5	0.023
	G3/8	<a href="#">3192 12 17</a>	12	19	19	38.5	30.5	0.027
	G1/2	<a href="#">3192 12 21</a>	16	24	19	43.5	30.5	0.050

The body swivels for positioning purposes.

## 3129 Extended Stud Elbow, Male BSPT Thread

Technical polymer, nickel-plated brass, NBR

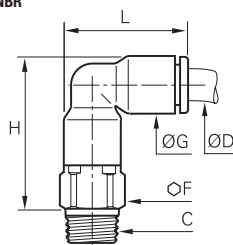

ØD	C		F	G	H	L	Kg
4	R1/8	<a href="#">3129 04 10</a>	10	8.5	23	19	0.009
	R1/4	<a href="#">3129 04 13</a>	14	8.5	23.5	19	0.018
6	R1/8	<a href="#">3129 06 10</a>	10	10.5	27	22.5	0.010
	R1/4	<a href="#">3129 06 13</a>	14	10.5	27.5	22.5	0.020
8	R1/8	<a href="#">3129 08 10</a>	13	13.5	34.5	29.5	0.018
	R1/4	<a href="#">3129 08 13</a>	14	13.5	32.5	29.5	0.022
	R3/8	<a href="#">3129 08 17</a>	17	13.5	33	29.5	0.032
10	R1/4	<a href="#">3129 10 13</a>	15	16	39.5	34.5	0.031
	R3/8	<a href="#">3129 10 17</a>	17	16	39.5	34.5	0.042
	R1/2	<a href="#">3129 10 21</a>	21	16	39.5	34.5	0.058
12	R1/4	<a href="#">3129 12 13</a>	19	19	45.5	40.5	0.051
	R3/8	<a href="#">3129 12 17</a>	19	19	45.5	40.5	0.047
	R1/2	<a href="#">3129 12 21</a>	21	19	45.5	40.5	0.052
14	R3/8	<a href="#">3129 14 17</a>	21	22	51.5	46.5	0.064
	R1/2	<a href="#">3129 14 21</a>	21	22	51.5	46.5	0.070

Pre-coated thread

The body swivels for positioning purposes.

Parker Legris offers the solution to enable many types of configuration options.

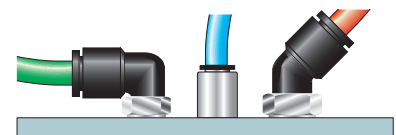



# Stud Fittings

## 3169 Extended Stud Elbow, Male BSPP and Metric Thread

Technical polymer, nickel-plated brass, NBR

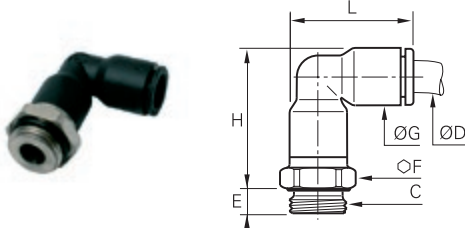

ØD	C		E	F	G	H	L	Kg
4	M5x0.8	3169 04 19	3.5	8	8.5	23	19	0.006
	M7x1	3169 04 55	4.5	10	8.5	22.5	19	0.008
	G1/8	3169 04 10	5	13	8.5	22.5	19	0.008
	G1/4	3169 04 13	5.5	16	8.5	22.5	19	0.013
6	M5x0.8	3169 06 19	3.5	10	10.5	27.5	23	0.008
	M7x1	3169 06 55	4.5	10	10.5	26	23	0.012
	G1/8	3169 06 10	5	13	10.5	27	23	0.011
	G1/4	3169 06 13	5.5	16	10.5	27	23	0.016
8	G1/8	3169 08 10	5	13	13.5	36	29.5	0.018
	G1/4	3169 08 13	5.5	16	13.5	33	29.5	0.020
	G3/8	3169 08 17	5.5	20	13.5	33	29.5	0.028
10	G1/4	3169 10 13	5.5	16	16	40.5	34.5	0.027
	G3/8	3169 10 17	5.5	20	16	40.5	34.5	0.036
	G1/2	3169 10 21	7.5	24	16	40.5	34.5	0.050
12	G1/4	3169 12 13	5.5	19	19	44.5	40.5	0.044
	G3/8	3169 12 17	5.5	20	19	42	40.5	0.038
	G1/2	3169 12 21	7.5	24	19	42	40.5	0.043
14	G3/8	3169 14 17	5.5	22	22	51	46.5	0.059
	G1/2	3169 14 21	7.5	24	22	48.5	46.5	0.063
16	G3/8	3169 16 17	7.5	27	27	82.5	52	0.220
	G1/2	3169 16 21	9	27	27	82.5	52	0.206

The body swivels for positioning purposes.

## 3113 45° Elbow, Male BSPT Thread

Technical polymer, nickel-plated brass, NBR

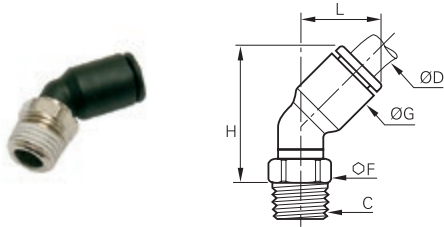

ØD	C		F	G	H	L	Kg
4	R1/8	3113 04 10	10	9	21	13	0.006
	R1/4	3113 04 10	10	11	24.5	14.5	0.006
6	R1/8	3113 06 10	14	11	25	14.5	0.015
	R1/4	3113 06 13	14	11	25	14.5	0.015
8	R1/8	3113 08 10	10	13.5	30	19.5	0.007
	R1/4	3113 08 13	14	13.5	28.5	19.5	0.014
	R3/8	3113 08 17	17	13.5	28.5	19.5	0.018
	R1/4	3113 10 13	15	16	33.5	23	0.014
10	R3/8	3113 10 17	17	16	33.5	23	0.019
	R1/2	3113 10 21	21	16	34	23	0.032
	R1/4	3113 12 13	15	19	39	26	0.016
12	R3/8	3113 12 17	17	19	39	26	0.022
	R1/2	3113 12 21	21	19	39	26	0.034

Pre-coated thread  
The body swivels for positioning purposes.  
This model prevents distortion of the tube.

## 3133 45° Elbow, Male BSPP and Metric Thread

Technical polymer, nickel-plated brass, NBR

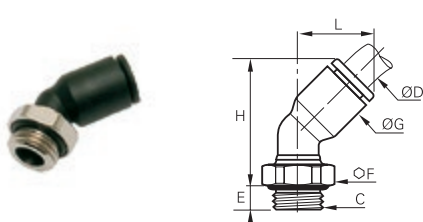

ØD	C		E	F	G	H	L	Kg
4	M5x0.8	3133 04 19	3.5	8	9	23	13	0.003
	G1/8	3133 04 10	4.5	13	9	20.5	13	0.006
6	M5x0.8	3133 06 19	3.5	8	11	28	14.5	0.003
	G1/8	3133 06 10	4.5	13	11	24	14.5	0.006
8	G1/4	3133 06 13	5.5	16	11	24	14.5	0.011
	G1/8	3133 08 10	4.5	13	13.5	31	19.5	0.009
	G1/4	3133 08 13	5.5	16	13.5	29	19.5	0.012
10	G3/8	3133 08 17	5.5	20	13.5	29	19.5	0.017
	G1/4	3133 10 13	5.5	16	16	35	23	0.014
	G3/8	3133 10 17	5.5	20	16	33.5	23	0.017
	G1/2	3133 10 21	7	24	16	33.5	23	0.026
12	G1/4	3133 12 13	5.5	16	19	40.5	26	0.016
	G3/8	3133 12 17	5.5	20	19	39	26	0.019
	G1/2	3133 12 21	7	24	19	39	26	0.028

The body swivels for positioning purposes.  
This model prevents distortion of the tube.

# Stud Fittings

## 3108 Stud Branch Tee, Male BSPT Thread

Technical polymer, nickel-plated brass, NBR

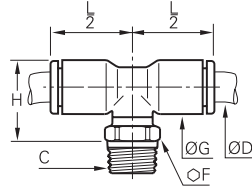

ØD	C		F	G	H	L/2	Kg
4	R1/8	<a href="#">3108 04 10</a>	10	8.5	15.5	14	0.006
	R1/4	<a href="#">3108 04 13</a>	14	8.5	16	14	0.015
6	R1/8	<a href="#">3108 06 10</a>	10	10.5	17.5	16	0.007
	R1/4	<a href="#">3108 06 13</a>	14	10.5	18	16	0.016
8	R1/8	<a href="#">3108 08 10</a>	10	13.5	22	23	0.009
	R1/4	<a href="#">3108 08 13</a>	14	13.5	21	23	0.016
10	R3/8	<a href="#">3108 08 17</a>	17	13.5	21	23	0.020
	R1/4	<a href="#">3108 10 13</a>	15	16	24	26.5	0.017
	R3/8	<a href="#">3108 10 17</a>	17	16	24	26.5	0.022
12	R1/2	<a href="#">3108 10 21</a>	21	16	24	26.5	0.035
	R1/4	<a href="#">3108 12 13</a>	15	19	27	31	0.021
	R3/8	<a href="#">3108 12 17</a>	17	19	27	31	0.026
14	R1/2	<a href="#">3108 12 21</a>	21	19	27	31	0.039
	R3/8	<a href="#">3108 14 17</a>	20	22	30.5	35	0.037
16	R1/2	<a href="#">3108 14 21</a>	24	22	28.5	35	0.048
	R3/8	<a href="#">3108 16 17</a>	27	27	53	38.5	0.128
	R1/2	<a href="#">3108 16 21</a>	27	27	53	38.5	0.124

Pre-coated thread. The body swivels for positioning purposes.

## 3198 Stud Branch Tee, Male BSPP and Metric Thread

Technical polymer, nickel-plated brass, NBR

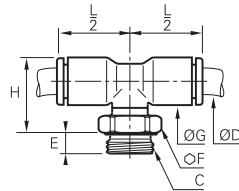

ØD	C		E	F	G	H	L/2	Kg
4	M5x0.8	<a href="#">3198 04 19</a>	3.5	8	8.5	17.5	14	0.003
	G1/8	<a href="#">3198 04 10</a>	5	13	8.5	15	14	0.006
	G1/4	<a href="#">3198 04 13</a>	5.5	16	8.5	15	14	0.011
6	M5x0.8	<a href="#">3198 06 19</a>	3.5	8	10.5	19.5	16	0.004
	G1/8	<a href="#">3198 06 10</a>	5	13	10.5	17	16	0.007
	G1/4	<a href="#">3198 06 13</a>	5.5	16	10.5	17	16	0.012
8	G1/8	<a href="#">3198 08 10</a>	4.5	13	13.5	23.5	23	0.011
	G1/4	<a href="#">3198 08 13</a>	5.5	16	13.5	21.5	23	0.014
	G3/8	<a href="#">3198 08 17</a>	5.5	20	13.5	21.5	23	0.019
10	G1/4	<a href="#">3198 10 13</a>	5.5	16	16	26	26.5	0.017
	G3/8	<a href="#">3198 10 17</a>	5.5	20	16	24	26.5	0.020
	G1/2	<a href="#">3198 10 21</a>	7.5	24	16	24	26.5	0.029
12	G1/4	<a href="#">3198 12 13</a>	5.5	16	19	29	31	0.021
	G3/8	<a href="#">3198 12 17</a>	5.5	20	19	27	31	0.024
	G1/2	<a href="#">3198 12 21</a>	7	24	19	27	31	0.033
14	G3/8	<a href="#">3198 14 17</a>	5.5	20	22	32.5	35.5	0.036
	G1/2	<a href="#">3198 14 21</a>	7	24	22	27	35.5	0.035
16	G3/8	<a href="#">3198 16 17</a>	7.5	27	27	54.5	38.5	0.121
	G1/2	<a href="#">3198 16 21</a>	9	27	27	54.5	38.5	0.117

The body swivels for positioning purposes.

## 3103 Stud Run Tee, BSPT Thread

Technical polymer, nickel-plated brass, NBR

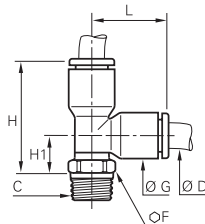

ØD	C		F	G	H	H1	L	Kg
4	R1/8	<a href="#">3103 04 10</a>	10	8.5	23.5	9	14.5	0.006
	R1/4	<a href="#">3103 04 13</a>	14	8.5	24	9.5	14.5	0.015
6	R1/8	<a href="#">3103 06 10</a>	10	10.5	27.5	10	17.5	0.007
	R1/4	<a href="#">3103 06 13</a>	14	10.5	28	10.5	17.5	0.016
8	R1/8	<a href="#">3103 08 10</a>	10	13.5	35	12	23	0.009
	R1/4	<a href="#">3103 08 13</a>	14	13.5	34	11	23	0.016
	R3/8	<a href="#">3103 08 17</a>	17	13.5	34	11	23	0.020
10	R1/4	<a href="#">3103 10 13</a>	15	16	40.5	14	26.5	0.017
	R3/8	<a href="#">3103 10 17</a>	17	16	40.5	14	26.5	0.022
	R1/2	<a href="#">3103 10 21</a>	21	16	40.5	14	26.5	0.035
12	R1/4	<a href="#">3103 12 13</a>	15	19	46.5	15.5	31	0.021
	R3/8	<a href="#">3103 12 17</a>	17	19	46.5	15.5	31	0.026
14	R1/2	<a href="#">3103 12 21</a>	21	19	46.5	15.5	31	0.039
	R3/8	<a href="#">3103 14 17</a>	20	22	55	19.5	35.5	0.038
16	R1/2	<a href="#">3103 14 21</a>	24	22	52.5	17.5	35.5	0.048
	R3/8	<a href="#">3103 16 17</a>	27	27	78	27	38.5	0.126
	R1/2	<a href="#">3103 16 21</a>	27	27	78	27	38.5	0.124

Pre-coated thread  
The body swivels for positioning purposes.

# Stud Fittings

## 3193 Stud Run Tee, Male BSPP and Metric Thread

Technical polymer, nickel-plated brass, NBR

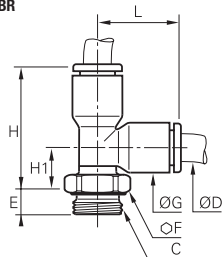

ØD	C		E	F	G	H	H1	L	Kg
4	M5x0.8	<a href="#">3193 04 19</a>	3.5	8	8.5	26	11.5	14.5	0.003
	G1/8	<a href="#">3193 04 10</a>	5	13	8.5	23	8.5	14.5	0.006
	G1/4	<a href="#">3193 04 13</a>	5.5	16	8.5	23	8.5	14.5	0.011
6	M5x0.8	<a href="#">3193 06 19</a>	3.5	8	10.5	29.5	12.5	17.5	0.004
	G1/8	<a href="#">3193 06 10</a>	5	13	10.5	27	10	17.5	0.007
	G1/4	<a href="#">3193 06 13</a>	5.5	16	10.5	27	10	17.5	0.012
8	G1/8	<a href="#">3193 08 10</a>	4.5	13	13.5	36.5	14	23	0.011
	G1/4	<a href="#">3193 08 13</a>	5.5	16	13.5	34.5	12	23	0.014
	G3/8	<a href="#">3193 08 17</a>	5.5	20	13.5	34.5	12	23	0.019
10	G1/4	<a href="#">3193 10 13</a>	5.5	16	16	42	15.5	26.5	0.017
	G3/8	<a href="#">3193 10 17</a>	5.5	20	16	40.5	14	26.5	0.020
	G1/2	<a href="#">3193 10 21</a>	7.5	24	16	40.5	14	26.5	0.029
12	G1/4	<a href="#">3193 12 13</a>	5.5	16	19	48	17	31	0.021
	G3/8	<a href="#">3193 12 17</a>	5.5	20	19	46.5	15.5	31	0.024
	G1/2	<a href="#">3193 12 21</a>	7	24	19	46.5	15.5	31	0.033
14	G3/8	<a href="#">3193 14 17</a>	5.5	20	22	56.5	21.5	35.5	0.036
	G1/2	<a href="#">3193 14 21</a>	7	24	22	51	16	35.5	0.035
	G3/8	<a href="#">3193 16 17</a>	7.5	27	27	79.5	41	38.5	0.121
16	G1/2	<a href="#">3193 16 21</a>	9	27	27	79.5	41	38.5	0.117

The body swivels for positioning purposes.

## 3148 Y Piece, Male BSPT Thread

Technical polymer, nickel-plated brass, NBR

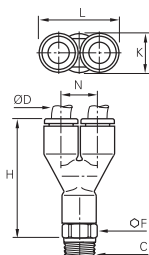

ØD	C		F	H	K	L	N	Kg
4	R1/8	<a href="#">3148 04 10</a>	10	32.5	8.5	17.5	9	0.009
	R1/4	<a href="#">3148 04 13</a>	14	33	8.5	17.5	9	0.019
6	R1/8	<a href="#">3148 06 10</a>	10	39.5	10.5	21.5	11	0.011
	R1/4	<a href="#">3148 06 13</a>	14	40	10.5	21.5	11	0.021
8	R1/8	<a href="#">3148 08 10</a>	13	56.5	13.5	28	14.5	0.020
	R1/4	<a href="#">3148 08 13</a>	14	55.5	13.5	28	14.5	0.025
10	R1/4	<a href="#">3148 10 13</a>	14	60	19	39	20	0.033
	R3/8	<a href="#">3148 10 17</a>	16	60.5	19	39	20	0.042
	R1/2	<a href="#">3148 10 21</a>	24	61	19	39	20	0.062
12	R3/8	<a href="#">3148 12 17</a>	19	66	19	39	20	0.053
	R1/2	<a href="#">3148 12 21</a>	21	66	19	39	20	0.059

Pre-coated thread

The body swivels for positioning purposes.

## 3158 Y Piece, Male BSPP and Metric Thread

Technical polymer, nickel-plated brass, NBR

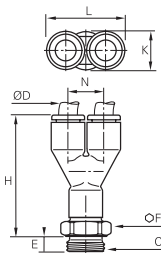

ØD	C		E	F	H	K	L	N	Kg
4	M5x0.8	<a href="#">3158 04 19</a>	3.5	8	32.5	8.5	17.5	9	0.006
	G1/8	<a href="#">3158 04 10</a>	5	13	32	8.5	17.5	9	0.009
	G1/4	<a href="#">3158 04 13</a>	5.5	16	32.5	8.5	17.5	9	0.014
6	M5x0.8	<a href="#">3158 06 19</a>	3.5	10	39.5	10.5	21.5	11	0.009
	G1/8	<a href="#">3158 06 10</a>	5	13	39	10.5	21.5	11	0.012
	G1/4	<a href="#">3158 06 13</a>	5.5	16	39.5	10.5	21.5	11	0.017
8	G1/8	<a href="#">3158 08 10</a>	5	13	49	13.5	28	14.5	0.020
	G1/4	<a href="#">3158 08 13</a>	5.5	16	49.5	13.5	28	14.5	0.023
	G3/8	<a href="#">3158 08 17</a>	6	19	48	13.5	28	14.5	0.030
10	G1/4	<a href="#">3158 10 13</a>	5.5	16	58	16	33	17	0.031
	G3/8	<a href="#">3158 10 17</a>	6	20	57.5	16	33	17	0.040
	G1/2	<a href="#">3158 10 21</a>	7	24	58	16	33	17	0.054
12	G3/8	<a href="#">3158 12 17</a>	6	20	62	19	39	20	0.044
	G1/2	<a href="#">3158 12 21</a>	7	24	63	19	39	20	0.050

The body swivels for positioning purposes.

# Stud Fittings

## 3112 Double Y Piece, Male BSPT Thread

Technical polymer, nickel-plated brass, NBR

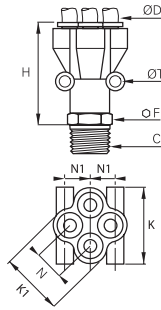

ØD	C		F	H	K	K1	N	N1	ØT	Kg
4	R1/8	<a href="#">3112 04 10</a>	13	41.5	25.5	21	10	8.5	3.7	0.022
	R1/4	<a href="#">3112 04 13</a>	14	43.5	25.5	21	10	8.5	3.7	0.027
6	R1/8	<a href="#">3112 06 10</a>	19	54.5	31.5	26.5	12	10	3.7	0.041
	R1/4	<a href="#">3112 06 13</a>	19	57.5	31.5	26.5	12	10	3.7	0.047

Pre-coated thread  
The body swivels for positioning purposes.

## 3132 Double Y, Male BSPP Thread

Technical polymer, nickel-plated brass, NBR

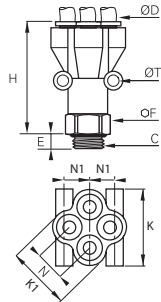

ØD	C		E	F	H	K	K1	N	N1	ØT	Kg
4	G1/8	<a href="#">3132 04 10</a>	5	13	41	25.5	21	10	8.5	3.7	0.022
	G1/4	<a href="#">3132 04 13</a>	5.5	16	40	25.5	21	10	8.5	3.7	0.026
6	G1/8	<a href="#">3132 06 10</a>	5	19	53.5	31.5	26.5	12	10	3.7	0.040
	G1/4	<a href="#">3132 06 13</a>	5.5	19	52.5	31.5	26.5	12	10	3.7	0.042

The body swivels for positioning purposes.

## 3100 Carstick® Cartridge

Brass, NBR

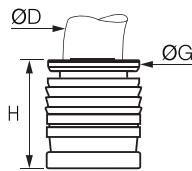

ØD		G	G1	H	L	Kg
4	<a href="#">3100 04 00</a>	8	11	10	554	0.001
6	<a href="#">3100 06 00</a>	10	14.5	11.5	629	0.002
8	<a href="#">3100 08 00</a>	13	15	15	794	0.002
10	<a href="#">3100 10 00</a>	15.5	19.5	17	930	0.005
12	<a href="#">3100 12 00</a>	19.5	21	19.5	1038	0.010
14	<a href="#">3100 14 00</a>	21	24.5	22.5	1100	0.013

50 cartridges per Carstick®.  
Cavity dimensions are available in chapter 2. For the 14 mm cartridge, please consult us regarding cavity dimensions.

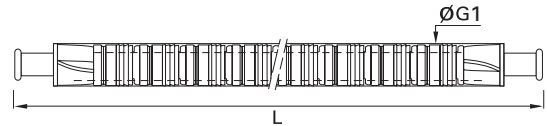

## 3100 Carstick® Cartridge

Nickel-plated brass, NBR

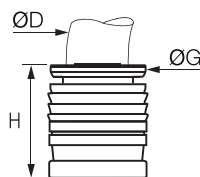

ØD		G	G1	H	L	Kg
1/8	<a href="#">3100 53 00 99</a>	7	10	9	508	0.002
1/4	<a href="#">3100 56 00 99</a>	10.5	14.5	12	600	0.003
3/8	<a href="#">3100 60 00 99</a>	15.5	19	16.5	930	0.006

50 cartridges per Carstick®.  
5/32" (4 mm) and 5/16" (8 mm) also available.  
Cavity dimensions are available in chapter 2.

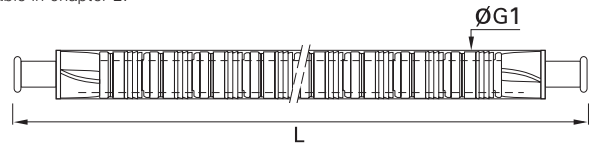

Other products are available upon request; please do not hesitate to consult us.

# Tube-to-Tube Fittings

## 3106 Equal and Unequal Tube-to-Tube Connector

Technical polymer, NBR

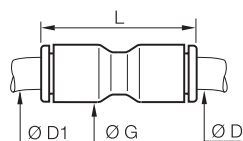

ØD	ØD1		G	L	Kg
3	3	<a href="#">3106 03 00</a>	8.5	25	0.002
	4	<a href="#">3106 03 04</a>	8.5	25	0.002
4	1/4	<a href="#">3106 04 56</a>	11	29.5	0.005
	4	<a href="#">3106 04 00</a>	8.5	25	0.001
	6	<a href="#">3106 04 06</a>	11	28	0.002
	8	<a href="#">3106 04 08</a>	13.5	38	0.005
6	1/4	<a href="#">3106 06 56</a>	13.5	36	0.009
	6	<a href="#">3106 06 00</a>	10.5	28.5	0.002
	8	<a href="#">3106 06 08</a>	13.5	38	0.005
	10	<a href="#">3106 06 10</a>	16	42	0.007
8	8	<a href="#">3106 08 00</a>	13.5	38	0.004
	10	<a href="#">3106 08 10</a>	16	42	0.008
	12	<a href="#">3106 08 12</a>	19	50.5	0.026
10	10	<a href="#">3106 10 00</a>	16	42	0.005
	12	<a href="#">3106 10 12</a>	19	50.5	0.019
12	1/2	<a href="#">3106 12 62</a>	22	56.5	0.024
	12	<a href="#">3106 12 00</a>	19	50.5	0.009
	14	<a href="#">3106 12 14</a>	22	56	0.026
	16	<a href="#">3106 12 16</a>	27	61	0.066
14	14	<a href="#">3106 14 00</a>	22	56	0.014
16	16	<a href="#">3106 16 00</a>	27	60.5	0.041

## 3106 Equal and Unequal Tube-to-Tube Connector

Inch

Technical polymer, NBR

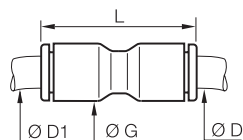

ØD	ØD1		G	L	Kg
1/4	1/4	<a href="#">3106 56 00</a>	10.9	29.5	0.002
	3/8	<a href="#">3106 60 00</a>	16	42	0.006
3/8	10	<a href="#">3106 60 10</a>	12	50.5	0.029
	1/4	<a href="#">3106 60 56</a>	16	41	0.016
1/2	1/2	<a href="#">3106 62 00</a>	22	55	0.016

5/32"(4 mm) and 5/16"(8 mm) also available

## 3102 Equal and Unequal Elbow

Technical polymer, NBR

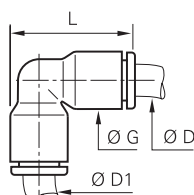

ØD	ØD1		G	L	Kg
4	4	<a href="#">3102 04 00</a>	8.5	19	0.001
	6	<a href="#">3102 04 06</a>	10.5	22.5	0.004
6	6	<a href="#">3102 06 00</a>	10.5	22.5	0.002
	8	<a href="#">3102 06 08</a>	13.5	29.5	0.008
8	8	<a href="#">3102 08 00</a>	13.5	29.5	0.004
	10	<a href="#">3102 08 10</a>	16	34.5	0.012
10	10	<a href="#">3102 10 00</a>	16	34.5	0.006
	12	<a href="#">3102 10 12</a>	19	40.5	0.020
12	12	<a href="#">3102 12 00</a>	19	40.5	0.010
14	14	<a href="#">3102 14 00</a>	22	46.5	0.015
16	16	<a href="#">3102 16 00</a>	27	52	0.043

## 3102 Equal and Unequal Elbow

Inch

Technical polymer, NBR

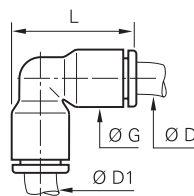

ØD	ØD1		G	L	Kg
1/4	1/4	<a href="#">3102 56 00</a>	11	23.5	0.002
3/8	3/8	<a href="#">3102 60 00</a>	16	34	0.006
1/2	1/2	<a href="#">3102 62 00</a>	22	35	0.017

5/32"(4 mm) and 5/16"(8 mm) also available

# Tube-to-Tube Fittings

## 3104 Equal and Unequal Tee

Technical polymer, NBR

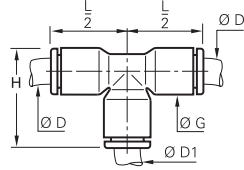

ØD	ØD1		G	H	L/2	Kg
3	3	<a href="#">3104 03 00</a>	8.5	19	14.5	0.004
4	4	<a href="#">3104 04 00</a>	8.5	19	14.5	0.002
	6	<a href="#">3104 04 06</a>	10.5	22.5	17.5	0.007
6	4	<a href="#">3104 06 04</a>	10.5	22.5	17.5	0.005
	6	<a href="#">3104 06 00</a>	10.5	22.5	17.5	0.003
	8	<a href="#">3104 06 08</a>	13.5	29.5	23	0.015
8	4	<a href="#">3104 08 04</a>	13.5	29	17.5	0.013
	6	<a href="#">3104 08 06</a>	13.5	29.5	23	0.010
	8	<a href="#">3104 08 00</a>	13.5	29.5	23	0.006
10	10	<a href="#">3104 08 10</a>	16	34.5	26.5	0.020
	4	<a href="#">3104 10 04</a>	16	33	26	0.023
	8	<a href="#">3104 10 08</a>	16	34.5	26.5	0.014
12	10	<a href="#">3104 10 00</a>	16	34.5	26.5	0.009
	12	<a href="#">3104 10 12</a>	19	40.5	31	0.034
	4	<a href="#">3104 12 04</a>	19	39	31	0.040
14	10	<a href="#">3104 12 10</a>	19	40.5	31	0.024
	12	<a href="#">3104 12 00</a>	19	40.5	31	0.014
16	8	<a href="#">3104 14 08</a>	22	46	35.5	0.053
	14	<a href="#">3104 14 00</a>	22	46	35.5	0.023
16	12	<a href="#">3104 16 12</a>	27	52.5	39	0.088
	16	<a href="#">3104 16 00</a>	27	52	39	0.063

## 3104 Equal and Unequal Tee

Inch

Technical polymer, NBR

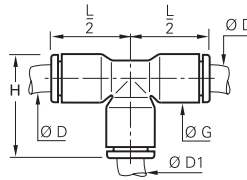

ØD	ØD1		G	H	L/2	Kg
5/32	1/4	<a href="#">3104 04 56</a>	11	23.5	18	0.008
1/8	1/8	<a href="#">3104 53 00</a>	8.4	19	14.5	0.003
	1/4	<a href="#">3104 53 56</a>	11	23.5	18	0.011
3/16	3/16	<a href="#">3104 55 00</a>	10.9	27.2	21.6	0.016
	5/32	<a href="#">3104 56 04</a>	11	23.5	18.5	0.014
	1/4	<a href="#">3104 56 00</a>	11	23	24	0.003
1/4	1/8	<a href="#">3104 56 53</a>	11	23.5	18.5	0.007
	3/8	<a href="#">3104 56 60</a>	16	33.5	24.5	0.017
	1/4	<a href="#">3104 60 56</a>	16	32.5	25.5	0.019
3/8	1/2	<a href="#">3104 60 62</a>	22	46	35	0.069
	3/8	<a href="#">3104 60 00</a>	16	34	26	0.009
	1/2	<a href="#">3104 62 00</a>	22	46	35	0.026
1/2	1/4	<a href="#">3104 62 56</a>	22.1	45.2	35.3	0.021
	3/8	<a href="#">3104 62 60</a>	22	46	35	0.060

5/32\*(4 mm) and 5/16\*(8 mm) also available

## 3140 Equal and Unequal Single Y Piece

Technical polymer, NBR

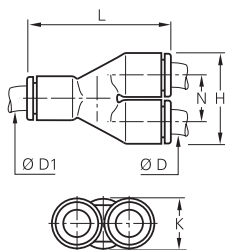

ØD	ØD1		H	K	L	N	Kg
4	4	<a href="#">3140 04 00</a>	17.5	8.5	28.5	9	0.002
	6	<a href="#">3140 04 06</a>	17.5	10.5	33	9	0.003
6	6	<a href="#">3140 06 00</a>	21.5	10.5	35	11	0.003
	8	<a href="#">3140 06 08</a>	22.5	13.5	41	11.5	0.005
8	8	<a href="#">3140 08 00</a>	28	13.5	45	14.5	0.006
	10	<a href="#">3140 08 10</a>	28	16	47	14.5	0.007
10	10	<a href="#">3140 10 00</a>	33	16	53	17	0.010
	12	<a href="#">3140 10 12</a>	33	19	57	17	0.012
12	12	<a href="#">3140 12 00</a>	39	19	57	17	0.017



# Tube-to-Tube Fittings

## 3107 Equal and Unequal Cross

Technical polymer, NBR

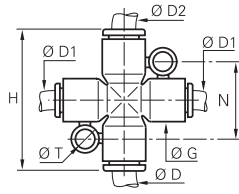

ØD	ØD1	ØD2		G	H	N	ØT	Kg
4	4	4	 <b>3107 04 00</b>	11	36	20	4.2	0.014
6	4	6	<b>3107 04 06</b>	11	36	20	4.2	0.009
4	4	6	<b>3107 06 04</b>	11	36	20	4.2	0.012
6	6	6	<b>3107 06 00</b>	11	36	20	4.2	0.005
8	6	8	<b>3107 06 08</b>	11	46	22.5	4.2	0.018
6	6	8	<b>3107 08 06</b>	13.5	46	22.5	4.2	0.022
8	8	8	<b>3107 08 00</b>	13.5	46	22.5	4.2	0.009

Boxes protect the contents and are designed to meet your requirements:

- part numbers and corresponding product pictures allow for immediate visual identification
- bar codes
- easy storage
- tamper-proof system of opening/closing
- recyclable material



# Bulkhead Connector Fittings

## 3116 Equal Bulkhead Connector

Technical polymer, NBR

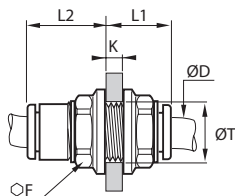

ØD		F	K <sub>max</sub>	L1	L2	ØT <sub>min</sub>	Kg
4	<a href="#">3116 04 00</a>	13	5.5	15	10	10.5	0.003
6	<a href="#">3116 06 00</a>	15	8.5	18	10.5	12.5	0.004
8	<a href="#">3116 08 00</a>	18	14.5	25	13.5	15.5	0.007
10	<a href="#">3116 10 00</a>	22	14.5	27.5	15.5	18.5	0.011
12	<a href="#">3116 12 00</a>	26	18.5	33	18	22.5	0.019
14	<a href="#">3116 14 00</a>	29	20.5	37.5	20.5	25.5	0.028

## 3146 Equal Mixed Bulkhead Connector

Nickel-plated brass, NBR

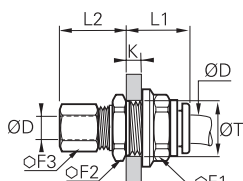

ØD		F1	F2	F3	K <sub>max</sub>	L1	L2	ØT <sub>min</sub>	Kg
4	<a href="#">3146 04 00</a>	13	13	10	7	17.5	17.5	10.5	0.018
6	<a href="#">3146 06 00</a>	15	17	13	8	19	18	12.5	0.029
8	<a href="#">3146 08 00</a>	18	19	14	8	20.5	20.5	15.5	0.036
10	<a href="#">3146 10 00</a>	22	22	19	8.5	23	24.5	18.5	0.066
12	<a href="#">3146 12 00</a>	26	25	22	8.5	27	25	22.5	0.096
14	<a href="#">3146 14 00</a>	29	29	24	10.5	27	27	25.5	0.124

Push-in connection with compression fitting

## 3136 Bulkhead Connector, Female BSPP Thread

Nickel-plated brass, NBR

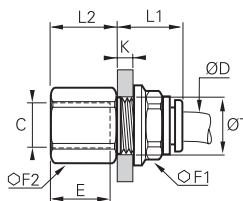

ØD	C		E	F1	F2	K <sub>max</sub>	L1	L2	ØT <sub>min</sub>	Kg
4	G1/8	<a href="#">3136 04 10</a>	9.5	13	13	7	17	11.5	10.5	0.015
	G1/4	<a href="#">3136 04 13</a>	13.5	13	16	7	17	15.5	10.5	0.021
6	G1/8	<a href="#">3136 06 10</a>	9.5	15	15	8	19	10.5	12.5	0.020
	G1/4	<a href="#">3136 06 13</a>	13.5	15	17	7	19	15.5	12.5	0.027
8	G3/8	<a href="#">3136 06 17</a>	12	15	22	8	19	16	12.5	0.041
	G1/8	<a href="#">3136 08 10</a>	9.5	18	17	8	20.5	10.5	15.5	0.029
10	G1/4	<a href="#">3136 08 13</a>	13.5	18	17	8	20.5	14.5	15.5	0.029
	G3/8	<a href="#">3136 10 17</a>	14	22	22	8.5	23	16	18.5	0.051
12	G3/8	<a href="#">3136 12 17</a>	14	26	24	8.5	27	16	22.5	0.079
	G1/2	<a href="#">3136 12 21</a>	19.5	26	27	8.5	27	21.5	22.5	0.098
16	G3/8	<a href="#">3136 16 17</a>	12	29	29	10.5	30	15	27.5	0.125
	G1/2	<a href="#">3136 16 21</a>	15	29	29	10.5	30	19.5	27.5	0.126

## 3139 Equal Bulkhead Elbow

Technical polymer, nickel-plated brass, NBR

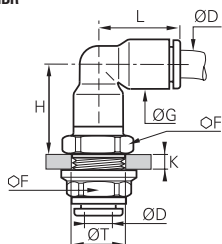

ØD		F	G	H	K <sub>max</sub>	L	ØT <sub>min</sub>	Kg
4	<a href="#">3139 04 00</a>	13	8.5	17	6.5	14.5	10.5	0.014
6	<a href="#">3139 06 00</a>	15	10.5	19.5	7	17.5	12.5	0.021
8	<a href="#">3139 08 00</a>	18	13.5	24	8	23	15.5	0.032
10	<a href="#">3139 10 00</a>	22	16	28	8.5	26	18.5	0.049
12	<a href="#">3139 12 00</a>	26	19	33	8.5	31	22.5	0.086
14	<a href="#">3139 14 00</a>	29	25.5	37.5	10.5	36	25.5	0.117

The body swivels for positioning purposes.

# Multiple Fittings

## 3144 Equal and Unequal Multiple Y Piece

Technical polymer, NBR

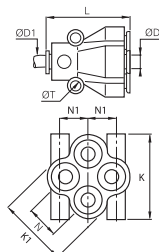

ØD	ØD1		K	K1	L	N	N1	ØT	Kg
4	4	<a href="#">3144 04 04</a>	25.5	21	30.5	10	8.5	3.7	0.016
	6	<a href="#">3144 04 06</a>	26	21	30.5	10	10	3.7	0.013
6	6	<a href="#">3144 06 06</a>	31.5	26.5	37.5	12	8.5	3.7	0.031
	8	<a href="#">3144 06 08</a>	31.5	26.5	38	12	10	3.7	0.026

## 3304 Multiple Tee

Technical polymer, NBR

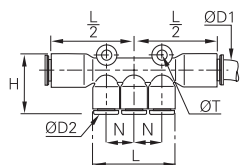

ØD1	ØD2		H	L	L/2	N	ØT	Kg
6	4	<a href="#">3304 06 04</a>	24.5	34	37	11.5	4.2	0.015
8	4	<a href="#">3304 08 04</a>	24.5	34	37	11.5	4.2	0.012
6	6	<a href="#">3304 06 06</a>	24.5	34	37	11.5	4.2	0.010
	8	<a href="#">3304 10 06</a>	36	44	40.5	14.5	4.2	0.019
10	8	<a href="#">3304 10 08</a>	36	44	40.5	15.5	4.2	0.015

## 3306 90° Multiple Elbow

Technical polymer, NBR

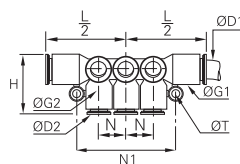

ØD1	ØD2		G	G1	H	L/2	N	N1	ØT	Kg
6	4	<a href="#">3306 06 04</a>	13.5	11	18.5	36	43	11.5	4.2	0.034
8	4	<a href="#">3306 08 04</a>	13.5	11	18.5	36.5	43	11.5	4.2	0.025
	6	<a href="#">3306 08 06</a>	13.5	11	18.5	36.5	43	11.5	4.2	0.022
10	6	<a href="#">3306 10 06</a>	16	13.5	23	42	52	14.5	4.2	0.048
	8	<a href="#">3306 10 08</a>	16	13.5	23.5	42	52	14.5	4.2	0.021

## 3310 In-Line Manifold

Treated aluminium, NBR

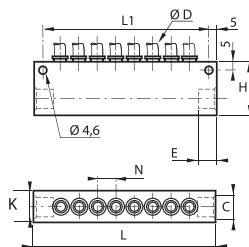

ØD	C		Number of Outlets	E	H	K	L	L1	N	Kg
4	G1/4	<a href="#">3310 04 13</a>	8	10	33	20	114	104	11.5	0.164
6	G1/4	<a href="#">3310 06 13</a>	8	10	33	20	114	104	12.5	0.170
8	G3/8	<a href="#">3310 08 17</a>	6	12	33	20	114	104	15	0.148
10	G1/2	<a href="#">3310 10 21</a>	6	16	48	25	145.5	135.5	17	0.334
12	G1/2	<a href="#">3310 12 21</a>	6	16	45	25	158	148	20.5	0.370

# Plug-In Fittings and Accessories

## 3182 Equal and Unequal Plug-In Elbow

Technical polymer, NBR

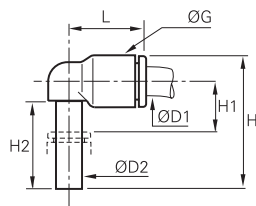

ØD1	ØD2		G	H	H1	H2	L	Kg
4	4	<a href="#">3182 04 00</a>	8.5	23	6	15.5	14	0.001
	6	<a href="#">3182 04 06</a>	10.5	26.5	7	17	16	0.003
6	4	<a href="#">3182 06 04</a>	10.5	24.5	7	15.5	16	0.001
	6	<a href="#">3182 06 00</a>	10.5	26.5	7	17	16	0.001
8	8	<a href="#">3182 08 00</a>	13.5	33.5	8	21.5	23	0.007
	10	<a href="#">3182 08 10</a>	16	39	10	24.5	26.5	0.010
10	10	<a href="#">3182 10 00</a>	16	39	10	24.5	26.5	0.004
	12	<a href="#">3182 10 12</a>	19	44.5	10.5	27.5	31	0.017
12	12	<a href="#">3182 12 00</a>	19	45.5	10.5	27.5	31	0.007

## 3182 Equal Plug-In Elbow

Inch

Technical polymer, NBR

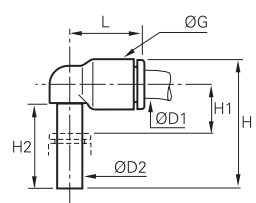

ØD1	ØD2		G	H	H1	H2	L	Kg
1/4	1/4	<a href="#">3182 56 00</a>	11	27.5	7.5	18	18.5	0.002
3/8	3/8	<a href="#">3182 60 00</a>	16	38.5	9	24	26	0.010
1/2	1/2	<a href="#">3182 62 00</a>	22	51	13	28	35	0.030

5/32"(4 mm) and 5/16"(8 mm) also available

## 3184 Extended Equal and Unequal Plug-In Elbow

Technical polymer, NBR

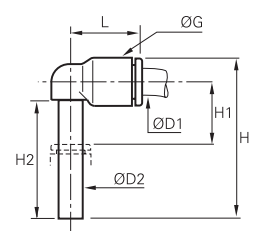

ØD1	ØD2		G	H	H1	H2	L	Kg
4	4	<a href="#">3184 04 00</a>	8.5	32.5	15.5	25	14	0.004
	6	<a href="#">3184 04 06</a>	10.5	38.5	19	29	16	0.004
6	6	<a href="#">3184 06 00</a>	10.5	38.5	19	29	16	0.002
	8	<a href="#">3184 06 08</a>	13.5	49	23.5	37	23	0.007
8	8	<a href="#">3184 08 00</a>	13.5	49	23.5	37	23	0.003
	10	<a href="#">3184 08 10</a>	16	56	26.5	41.5	26.5	0.011
10	10	<a href="#">3184 10 00</a>	16	56	26.5	41.5	26.5	0.005
	12	<a href="#">3184 10 12</a>	19	62.5	28	45.5	31	0.017
12	12	<a href="#">3184 12 00</a>	19	62.5	28	45.5	31	0.008

## 3180 45° Plug-In Equal Elbow

Technical polymer, NBR

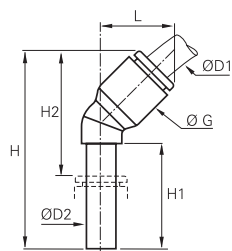

ØD1	ØD2		G	H	H1	H2	L	Kg
4	4	<a href="#">3180 04 00</a>	9	33.5	19	21	13	0.001
6	6	<a href="#">3180 06 00</a>	11	39	21	25	14.5	0.002
8	8	<a href="#">3180 08 00</a>	13.5	44	21.5	25.5	19.5	0.003
10	10	<a href="#">3180 10 00</a>	16	53	27	32.5	23	0.004
12	12	<a href="#">3180 12 00</a>	19	58.5	27.5	34	26.5	0.007

# Plug-In Fittings and Accessories

## 3183 Equal and Unequal Plug-In Run Tee

Technical polymer, NBR

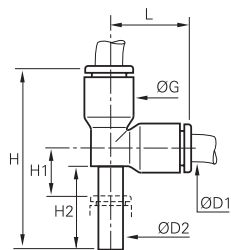

ØD1	ØD2		G	H	H1	H2	L	Kg
4	4	<a href="#">3183 04 00</a>	8.5	33	6	15.5	14.5	0.002
	6	<a href="#">3183 04 06</a>	10.5	38.5	7	17	17.5	0.007
6	6	<a href="#">3183 06 00</a>	10.5	38.5	7	17	17	0.002
	8	<a href="#">3183 06 08</a>	13.5	48.5	8	21.5	23	0.013
8	8	<a href="#">3183 08 00</a>	13.5	49	8	21.5	23	0.005
	10	<a href="#">3183 08 10</a>	16	56.5	10.5	24.5	26.5	0.018
10	10	<a href="#">3183 10 00</a>	16	57	10.5	24.5	26.5	0.007
	12	<a href="#">3183 10 12</a>	19	65.5	10.5	27.5	31	0.034
12	12	<a href="#">3183 12 00</a>	19	65.5	10.5	27.5	31	0.011

## 3188 Equal and Unequal Plug-In Branch Tee

Technical polymer, NBR

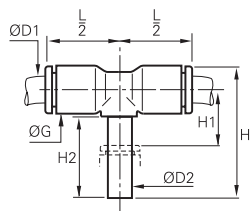

ØD1	ØD2		G	H	H1	H2	L/2	Kg
4	4	<a href="#">3188 04 00</a>	8.5	25	8	15.5	14.5	0.002
	6	<a href="#">3188 04 06</a>	10.5	28.5	9	17	16	0.007
6	6	<a href="#">3188 06 00</a>	10.5	28.5	9	17	16	0.002
	8	<a href="#">3188 06 08</a>	13.5	36.5	11	21.5	22	0.014
8	8	<a href="#">3188 08 00</a>	13.5	36.5	11	21.5	23	0.004
	10	<a href="#">3188 08 10</a>	16	41	12.5	24.5	26.5	0.018
10	10	<a href="#">3188 10 00</a>	16	41	12.5	24.5	26.5	0.007
	12	<a href="#">3188 10 12</a>	19	46.5	12.5	27.5	31	0.031
12	12	<a href="#">3188 12 00</a>	19	46.5	12.5	27.5	31	0.012

## 3142 Equal and Unequal Plug-In Single Y Piece

Technical polymer, NBR

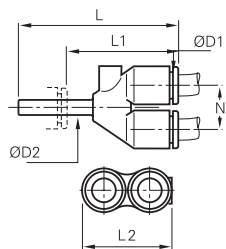

ØD1	ØD2		L	L1	L2	N	Kg
4	4	<a href="#">3142 04 00</a>	34	21.5	17.5	9	0.002
	6	<a href="#">3142 04 06</a>	35.5	21.5	17.5	9	0.002
6	6	<a href="#">3142 06 00</a>	39.5	25.5	21.5	11	0.004
	8	<a href="#">3142 06 08</a>	44	25.5	21.5	11	0.015
8	8	<a href="#">3142 08 00</a>	50.5	32	28	14.5	0.007
	10	<a href="#">3142 08 10</a>	53.5	32	28	14.5	0.024
10	10	<a href="#">3142 10 00</a>	57.5	36	33	17	0.010
	12	<a href="#">3142 10 12</a>	60	35	33	17	0.037
12	12	<a href="#">3142 12 00</a>	66	41	39	20	0.017

## 3143 Multiple Plug-In Y Piece

Technical polymer, nickel-plated brass, NBR

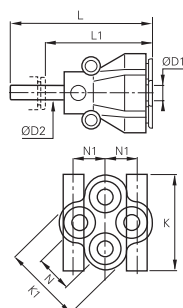

ØD1	ØD2		K	K1	L	L1	N	N1	Kg
4	6	<a href="#">3143 04 06</a>	26	21.5	49.5	35.5	11	8.5	0.018
	8	<a href="#">3143 04 08</a>	26	21.5	51	32	11	8.5	0.021
6	8	<a href="#">3143 06 08</a>	31.5	26.5	57.5	39	12	10	0.035

# Plug-In Fittings and Accessories

## 3120 Stem Connector

Technical polymer

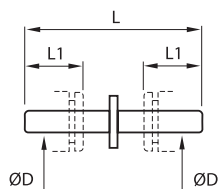

ØD		L	L1	Kg
4	<a href="#">3120 04 00</a>	34.5	12	0.001
6	<a href="#">3120 06 00</a>	38.5	14	0.001
8	<a href="#">3120 08 00</a>	41	18.5	0.001
10	<a href="#">3120 10 00</a>	51.5	20.5	0.002
12	<a href="#">3120 12 00</a>	60	24.5	0.004
14	<a href="#">3120 14 00</a>	69.5	25.5	0.007

This model exists in nickel-plated brass; please use suffix 85. Example: 3120 04 00 85  
Only compatible with Parker Legris fittings. Drawing available upon request.

## 3166 Plug-In Reducer

Technical polymer, NBR

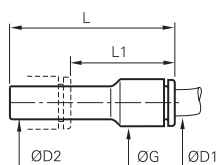

ØD1	ØD2		G	L	L1	Kg
3	4	<a href="#">3166 03 04</a>	8.5	37.5	23.5	0.002
4	6	<a href="#">3166 04 06</a>	8.5	37.5	23.5	0.001
4	8	<a href="#">3166 04 08</a>	8.5	37.5	19	0.001
	10	<a href="#">3166 04 10</a>	12	44	22.5	0.003
6	8	<a href="#">3166 06 08</a>	10.5	37.5	20	0.001
	10	<a href="#">3166 06 10</a>	10.5	38	17.5	0.002
	12	<a href="#">3166 06 12</a>	14.5	46	23	0.005
8	14	<a href="#">3166 08 14</a>	14.5	48	23	0.006
	10	<a href="#">3166 08 10</a>	13.5	49	28.5	0.003
	12	<a href="#">3166 08 12</a>	13.5	49	24.5	0.004
8	14	<a href="#">3166 08 14</a>	17	48	23	0.007
	12	<a href="#">3166 10 12</a>	21.5	56.5	33.5	0.005
10	14	<a href="#">3166 10 14</a>	21.5	58.5	33.5	0.005
	12	<a href="#">3166 12 14</a>	23.5	58.5	33.5	0.007

## 3166 Plug-In Reducer

Inch

Technical polymer, NBR

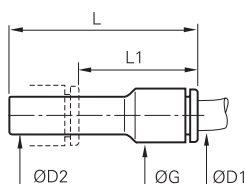

ØD1	ØD2		G	L	L1	Kg
1/4	5/16	<a href="#">3166 56 08</a>	11	41	23	0.002
	3/8	<a href="#">3166 56 60</a>	11	41	21	0.002

## 3168 Plug-In Increaser

Technical polymer, NBR

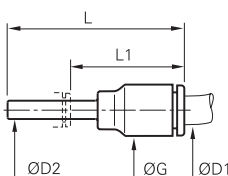

ØD1	ØD2		G	L	L1	Kg
6	4	<a href="#">3168 06 04</a>	10.5	35	23	0.001
8	6	<a href="#">3168 08 06</a>	13.5	45	31.5	0.003
	1/4	<a href="#">3168 08 56</a>	16	40	25.5	0.009
10	8	<a href="#">3168 10 08</a>	16	42.5	21	0.004
12	10	<a href="#">3168 12 10</a>	19	49	24.5	0.012

## 3168 Plug-In Increaser

Inch

Technical polymer, NBR

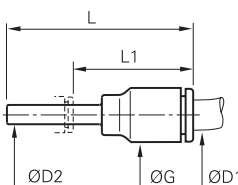

ØD1	ØD2		G	L	L1	Kg
1/4	3/16	<a href="#">3168 56 55</a>	20.5	41	25	0.002
	5/32	<a href="#">3168 56 04</a>	11	41	29	0.001



# Plug-In Fittings and Accessories

## 3126 Blanking Plug

Technical polymer

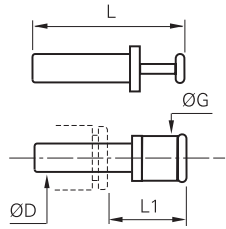

ØD		G	L	L1	Kg
3	<a href="#">3126 03 00</a>	6	25	13.5	0.001
4	<a href="#">3126 04 00</a>	4	30	15.5	0.001
6	<a href="#">3126 06 00</a>	8	33	16.5	0.001
8	<a href="#">3126 08 00</a>	10	35	17.5	0.001
10	<a href="#">3126 10 00</a>	12	42	21	0.002
12	<a href="#">3126 12 00</a>	14	45	22	0.003
14	<a href="#">3126 14 00</a>	16	49	23.5	0.005
16	<a href="#">3126 16 00*</a>	19	57	30	0.064

\*Nickel-plated brass

## 3126 Blanking Plug

Inch

Technical polymer

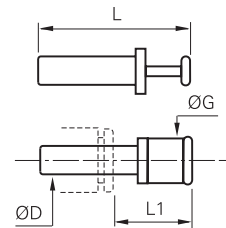

ØD		G	L	L1	Kg
1/4	<a href="#">3126 56 00</a>	8	36.5	22	0.001
3/8	<a href="#">3126 60 00</a>	12	42	22	0.002
1/2	<a href="#">3126 62 00</a>	15	48.5	21.5	0.003

5/32"(4 mm) and 5/16"(8 mm) also available

## 3122 Plug-In Barb Connector

Technical polymer

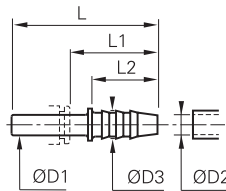

ØD1	ØD2		ØD3	L	L1	L2	Kg
4	3.2	<a href="#">3122 04 53</a>	5	37	25	17	0.004
	5	<a href="#">3122 04 05</a>	7	37	25	17	0.005
6	5	<a href="#">3122 06 05</a>	7	39	25	17	0.001
	6.3	<a href="#">3122 08 56</a>	8.5	39.5	21	17	0.001
8	8	<a href="#">3122 08 08</a>	10	44.5	26	22	0.001
	6.3	<a href="#">3122 10 56</a>	8	45	24.5	17	0.002
10	8	<a href="#">3122 10 08</a>	10	50	29.5	22	0.002
	8	<a href="#">3122 12 08</a>	10	50	26	22	0.002
12	10	<a href="#">3122 12 10</a>	12	48.5	25.5	22.5	0.002
	12.5	<a href="#">3122 12 62</a>	14.5	57	34	22.5	0.004
14	12.5	<a href="#">3122 14 62</a>	14.5	59.5	34.5	22.5	0.022

## 3151 End Cap

Technical polymer, NBR

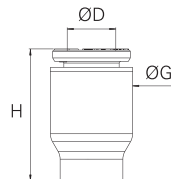

ØD		G	H	Kg
4	<a href="#">3151 04 00</a>	8.5	15	0.001
6	<a href="#">3151 06 00</a>	10.5	17	0.001
8	<a href="#">3151 08 00</a>	13.5	22	0.003
10	<a href="#">3151 10 00</a>	16	22	0.003
12	<a href="#">3151 12 00</a>	19	28	0.005
14	<a href="#">3151 14 00</a>	22	31	0.009

Other products are available upon request; please do not hesitate to consult us.

# Banjo Fittings

This range of fittings is ideal when access is only possible from above and **orientation of the tube** is required. This range of modular fittings includes single and multiple configurations, allowing **wide flexibility of design**.

## Product Advantages

**Compact**

- Compact design with minimum space between fittings
- Banjo bolt designed for maximum flow
- Easy access, even when fittings are close together
- Easy assembly and automatic sealing:
  - with pre-coating on taper threads
  - with an integral O-ring seal on parallel threads
- Safe operation: orientation of tube is ensured
- 100% leak-tested in production
- Date coding to guarantee quality and traceability

**Modular**

- Effortless stacking of banjo bodies to allow construction of 2 to 6 outlets
- Orientable (360°) for perfect alignment
- Modular: tube diameters may be different



**Applications**

- Robotics
- Automotive Process
- Pneumatics
- Semi-Conductors
- Textile
- Packaging

## Technical Characteristics

<b>Compatible Fluids</b>	Compressed air Other fluids: please consult us
<b>Working Pressure</b>	Vacuum to 20 bar
<b>Working Temperature</b>	-20°C to +80°C

Tightening Torque (daN.m)	Threads					
	M3 x0.5	M5 x0.8	G1/8	G1/4	G3/8	G1/2
	0.05	0.1	0.4	0.5	0.6	0.7

Reliable performance is dependent upon the type of fluid conveyed, component materials and tubing being used.  
Use is guaranteed with a vacuum of 755 mm Hg (99% vacuum).

### Component Materials

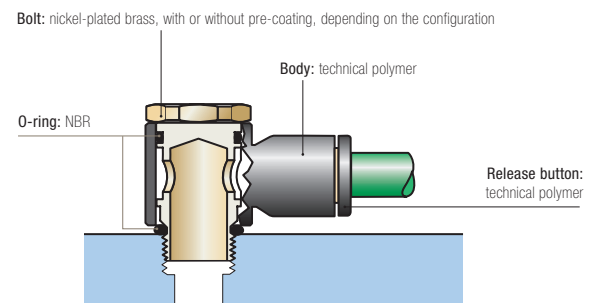

### Silicone-free

### Regulations

ISO 14743: Pneumatic fluid power, push-in connectors for thermoplastic tubes  
 DI : 2002/95/EC (RoHS)  
 2011/65/EC  
 DI : 97/23/EC (PED)  
 DI : 1907/2006 (REACH)

## Installation Configurations

Thread and bore diameters for part numbers 3524 - 3527 - 3528 - 3529:

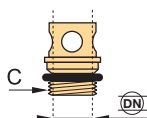

Thread (C)	M5x0.8	G1/8	G1/4	G3/8	G1/2
DN	2.5	5.5	8.5	11	13

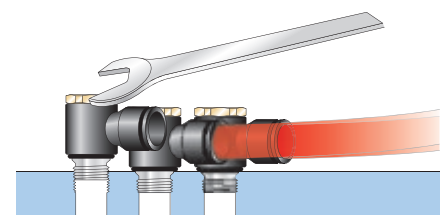

# Banjo Fittings

## 3118 Single Banjo, Male BSPP and Metric Thread

Technical polymer, nickel-plated brass, NBR

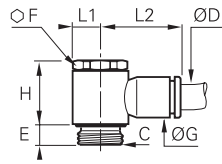

ØD	C		E	F	G	H	L1	L2	Kg
3	M3x0.5	<a href="#">3118 03 09*</a>	3	-	8.5	13	5	16	0.005
	M5x0.8	<a href="#">3118 03 19*</a>	4	-	8.5	13	5	16	0.005
4	M5x0.8	<a href="#">3118 04 19*</a>	4	-	8.5	13	5	16.5	0.004
	G1/8	<a href="#">3118 04 10</a>	4	13	8.5	17	7	18.5	0.012
6	M5x0.8	<a href="#">3118 06 19*</a>	4	-	10.5	13	7	18.5	0.004
	G1/8	<a href="#">3118 06 10</a>	4	13	10.5	17	7	20	0.013
6	G1/4	<a href="#">3118 06 13</a>	5.5	17	10.5	21	9.5	22	0.023
	G1/8	<a href="#">3118 08 10</a>	4	13	13.5	16.5	7	25	0.014
8	G1/4	<a href="#">3118 08 13</a>	5.5	17	13.5	21	9	27	0.024
	G3/8	<a href="#">3118 08 17</a>	5.5	20	13.5	24.5	11	29	0.038
8	G1/4	<a href="#">3118 10 13</a>	5.5	17	16	21	9.5	29	0.025
	G3/8	<a href="#">3118 10 17</a>	5.5	20	16	24.5	11	31	0.039
10	G1/2	<a href="#">3118 10 21</a>	8	25	19	27.5	13.5	36.5	0.084
	G3/8	<a href="#">3118 12 17</a>	5.5	20	19	24.5	11	34.5	0.041
12	G1/2	<a href="#">3118 12 21</a>	8	25	19	27.5	13.5	36.5	0.074

\*With screwdriver slot

## 3018 Single Banjo, Male BSPT Thread

Technical polymer, nickel-plated brass, NBR

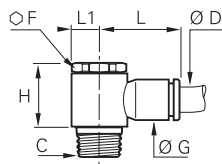

ØD	C		F	G	H	L	L1	Kg
4	R1/8	<a href="#">3018 04 10</a>	13	8.5	18.5	18.5	7	0.015
	R1/8	<a href="#">3018 06 10</a>	13	10.5	18.5	20	7	0.015
6	R1/4	<a href="#">3018 06 13</a>	17	10.5	22.5	22	9.5	0.029
	R1/8	<a href="#">3018 08 10</a>	13	13.5	18.5	25	7	0.016
8	R1/4	<a href="#">3018 08 13</a>	17	13.5	22.5	27	9.5	0.030
	R3/8	<a href="#">3018 08 17</a>	21	13.5	26.5	29	11	0.047
10	R1/4	<a href="#">3018 10 13</a>	17	16	22.5	29	9.5	0.031
	R3/8	<a href="#">3018 10 17</a>	21	16	26.5	31	11	0.048
12	R1/4	<a href="#">3018 12 13</a>	21	19	26.5	34.5	11	0.051
	R3/8	<a href="#">3018 12 17</a>	21	19	26.5	34.5	11	0.050
12	R1/2	<a href="#">3018 12 21</a>	25	19	30	37	13.5	0.086

Pre-coated thread

## 3124 Single Banjo, Male/Female BSPP and Metric Thread

Technical polymer, nickel-plated brass, NBR

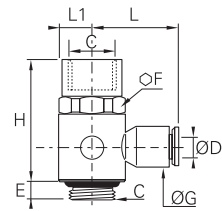

ØD	C		E	F	G	H	L	L1	Kg
4	M5x0.8	<a href="#">3124 04 19</a>	4	8	8.5	19	16	5	0.006
	G1/8	<a href="#">3124 04 10</a>	4	13	8.5	25.5	18.5	7	0.015
6	G1/4	<a href="#">3124 06 13</a>	5.5	17	10.5	33	22	9	0.030
	G3/8	<a href="#">3124 08 17</a>	5.5	20	13.5	37.5	29	11	0.043

This product family was developed to allow assembly of a function fitting on a cylinder.

## 3149 Twin Banjo, Male BSPP and Metric Thread

Technical polymer, nickel-plated brass, NBR

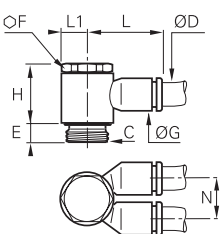

ØD	C		E	F	G	H	L	L1	N	Kg
4	M5x0.8	<a href="#">3149 04 19*</a>	4	-	8.5	13	16	4.5	9	0.005
	G1/8	<a href="#">3149 04 10</a>	4	13	10.5	16.5	18.5	7	11.5	0.018
6	G1/8	<a href="#">3149 06 10</a>	4	13	10.5	16.5	18.5	7	11.5	0.014
	G1/4	<a href="#">3149 06 13</a>	5.5	17	13.5	21	27	9.5	14.5	0.035
6	G1/4	<a href="#">3149 08 13</a>	5.5	17	13.5	21	27	9.5	14.5	0.026
	G3/8	<a href="#">3149 08 17</a>	5.5	20	16	24.5	31	11	17	0.053
10	G3/8	<a href="#">3149 10 17</a>	5.5	20	16	24.5	31	11	17	0.042

\*With screwdriver slot

## 3119 Double Banjo, BSPP and Metric Thread

Technical polymer, nickel-plated brass, NBR

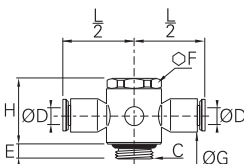

ØD	C		E	F	G	H	L/2	Kg
4	M5x0.8	<a href="#">3119 04 19*</a>	4	-	8.5	13	8	0.005
	G1/8	<a href="#">3119 04 10</a>	4	13	11	17	20	0.018
6	G1/8	<a href="#">3119 06 10</a>	4	13	11	17	20	0.014
	G1/4	<a href="#">3119 06 13</a>	5.5	17	13.5	21	26.5	0.035
8	G1/4	<a href="#">3119 08 13</a>	5.5	17	13.5	21	27	0.026
	G3/8	<a href="#">3119 08 17</a>	5.5	20	16	24.5	30.5	0.053
10	G3/8	<a href="#">3119 10 17</a>	5.5	20	16	24.5	31	0.045

\*With screwdriver slot

# Banjo Fittings

## 3538 Single Banjo Bodies

Technical polymer, NBR

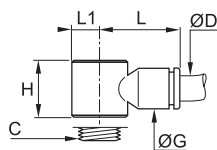

ØD	C		G	H	L	L1	Kg
3	M5x0.8	<a href="#">3538 03 19</a>	8.5	13	16	5	0.003
	M5x0.8	<a href="#">3538 04 19</a>	8.5	13	16	5	0.001
4	G1/8	<a href="#">3538 04 10</a>	10.5	14.5	18.5	7	0.002
	M5x0.8	<a href="#">3538 06 19</a>	11	13	18.5	5	0.002
6	G1/8	<a href="#">3538 06 10</a>	10.5	14.5	20	7	0.002
	G1/4	<a href="#">3538 06 13</a>	13.5	18	22	9.5	0.003
8	G1/8	<a href="#">3538 08 10</a>	13.5	14.5	25	7	0.003
	G1/4	<a href="#">3538 08 13</a>	13.5	18	27	9.5	0.004
10	G3/8	<a href="#">3538 10 13</a>	16	18	29	11.5	0.009
	G1/2	<a href="#">3538 10 17</a>	16	18	29	9.5	0.005
12	G3/8	<a href="#">3538 12 17</a>	19	21.5	31	11.5	0.006
	G1/2	<a href="#">3538 12 21</a>	19	21.5	31	11.5	0.019

## 3539 Double Banjo Bodies

Technical polymer, NBR

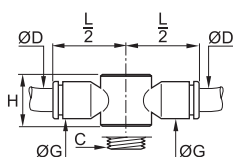

ØD	C		G	H	L/2	Kg
4	M5x0.8	<a href="#">3539 04 19</a>	8.5	13	16	0.002
	G1/8	<a href="#">3539 04 10</a>	10.5	14.4	20	0.008
6	G1/8	<a href="#">3539 06 10</a>	10.5	14.4	20	0.011
	G1/4	<a href="#">3539 06 13</a>	13.5	18	26	0.015
8	G1/4	<a href="#">3539 08 13</a>	13.5	18	27	0.013
	G3/8	<a href="#">3539 08 17</a>	16	21.5	30.5	0.020
10	G3/8	<a href="#">3539 10 17</a>	16	21.5	31	0.016

## 3549 Twin Banjo Bodies

Technical polymer, NBR

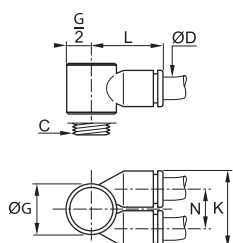

ØD	C		G	K	L	N	Kg
4	M5x0.8	<a href="#">3549 04 19</a>	10	17.5	15.5	9	0.003
	G1/8	<a href="#">3549 04 10</a>	14	22.5	20	12	0.007
	G1/4	<a href="#">3549 04 13</a>	18.5	28	25	14.5	0.020
6	G1/8	<a href="#">3549 06 10</a>	14	22.5	20.5	12	0.003
	G1/4	<a href="#">3549 06 13</a>	18.5	28	25	14.5	0.015
8	G3/8	<a href="#">3549 06 17</a>	22.5	33	28.5	17	0.031
	G1/4	<a href="#">3549 08 13</a>	18.5	28	26	14.5	0.006
10	G3/8	<a href="#">3549 08 17</a>	22.5	33	29.5	17	0.020
	G3/8	<a href="#">3549 10 17</a>	22.5	33	29.5	17	0.009

# Modular Banjo Fittings

## 3527 Single Banjo Bolts, Male BSPP and Metric Thread

Nickel-plated brass, NBR

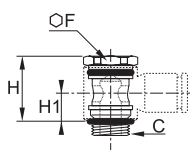

C		F	H	H1	Kg
M5x0.8	<a href="#">3527 00 19*</a>	-	17	7.5	0.003
G1/8	<a href="#">3527 00 10</a>	13	17	7.5	0.011
G1/4	<a href="#">3527 00 13</a>	17	21	9.5	0.020
G3/8	<a href="#">3527 00 17</a>	20	24.5	11	0.033
G1/2	<a href="#">3527 00 21</a>	25	27.5	11.5	0.064

\*With screwdriver slot  
Full bore

## 3528 Stacking Banjo for 2 Body High Modules, Male BSPP and Metric Thread

Nickel-plated brass, NBR

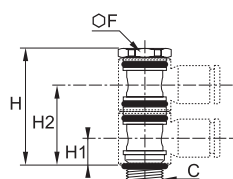

C		F	H	H1	H2	Kg
M5x0.8	<a href="#">3528 00 19*</a>	-	24.5	7.5	18.5	0.005
G1/8	<a href="#">3528 00 10</a>	13	31	7.5	22	0.017
G1/4	<a href="#">3528 00 13</a>	17	39	9.5	27.5	0.031
G3/8	<a href="#">3528 00 17</a>	20	46	11	32.5	0.053

\*With screwdriver slot  
Full bore  
Designed for use with 2 banjo bodies

## 3529 Stacking Banjo for 3 Body High Modules, Male BSPP Thread

Nickel-plated brass, NBR

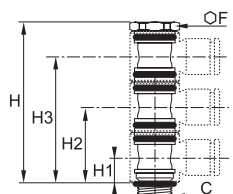

C		F	H	H1	H2	H3	Kg
G1/8	<a href="#">3529 00 10</a>	13	45.5	7.5	22	36	0.023
G1/4	<a href="#">3529 00 13</a>	17	54	9.5	27.5	45.5	0.042
G3/8	<a href="#">3529 00 17</a>	20	67.5	11	32.5	54	0.069

Full bore  
Designed for use with 2 banjo bodies

## 3524 Threaded Banjo Bolts, Male/Female BSPP and Metric Thread

Nickel-plated brass, NBR

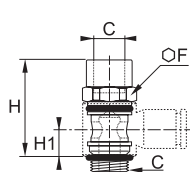

C		F	H	H1	Kg
M5x0.8	<a href="#">3524 00 19</a>	8	17	7.5	0.005
G1/8	<a href="#">3524 00 10</a>	13	24.5	7.5	0.013
G1/4	<a href="#">3524 00 13</a>	17	33	9.5	0.027
G3/8	<a href="#">3524 00 17</a>	20	37.5	11	0.039
G1/2	<a href="#">3524 00 21</a>	26	42	11.5	0.067

Full bore

Banjo bolts 3527, 3528, 3529 and 3524 are only usable in association with the corresponding bodies for modular construction 3538, 3539 and 3549.

Thread and passage size for part numbers 3527, 3528, 3529 and 3524.

Thread	M5x0.8	G1/8	G1/4	G3/8	G1/2
DN	2.5	5.5	8.5	11	13

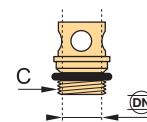

# Modular Plug-In Connectors

These connectors allow a **maximum number of tube connections** in a **minimum of space**. Parker Legris offers an **ergonomic solution** to enable quick connection for the most complex installations.

## Product Advantages

- Panel-Mounted** | Panel mounted to a machine or bulkhead  
 Reduced risk of incorrect assembly  
 Possible to connect in-line  
 Plated metal joiners and clips for reinforcement
- In-Line** | Locating pin prevents incorrect assembly  
 Cap guides the tubes and protects connections  
 Aluminium and technical polymer components  
 Bulkhead mountable  
 Customised multi-connectors upon request
- DIN Rail** | Used alongside electrical connectors  
 Pressure indication  
 Can be clipped side-by-side into a DIN rail profile [ or  $\Omega$  ]  
 Channels or slots for labels for tube identification



Robotics  
 Automotive Process  
 Pneumatics  
 Semi-Conductors  
 Textile  
 Packaging

Applications

## Technical Characteristics

<b>Compatible Fluids</b>	Compressed air Other fluids: please consult us
<b>Working Pressure</b>	Vacuum to 10 bar
<b>Working Temperature</b>	-20°C to +80°C

Reliable performance is dependent upon the type of fluid conveyed, component materials and tubing being used.  
 Use is guaranteed with a vacuum of 755 mm Hg (99% vacuum).

### Component Materials

- Multi-connectors:**
- panel-mounted: zinc-plated steel, technical polymer
  - in-line: aluminium, technical polymer
  - DIN rail: technical polymer

Connections: LF 3000®



**Silicone-free**

## Installation Configurations

### Panel-Mounted

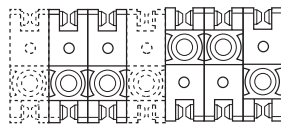

Standard assembly      Customised assembly

A box contains:

- 10 units
- 20 joining clips and 4 end pins
- 4 mounting brackets
- 4 coupling clips
- 1 dismantling tool

The module is constructed from a number of symmetrical components connected by joining clips. A coupling clip locks the module closed. A dismantling tool allows disconnection.

Maximum 5 modules recommended for the mating module; the fixed module is not limited.

### In-Line



### Regulations

ISO 14743: Pneumatic fluid power, push-in connectors for thermoplastic tubes  
 DI: 97/23/EC (PED)  
 DI: 2002/95/EC (RoHS), 2011/65/EC  
 DI: 1907/2006 (REACH)

### DIN Rail Connector

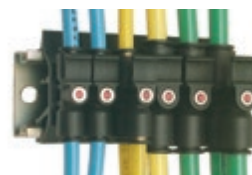



# Modular Plug-In Connectors

## 3300 Modular Plug-In Connector

Technical polymer, NBR

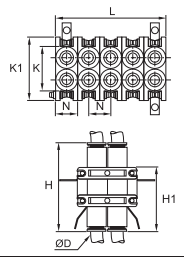

ØD		B	H	H1	K	K1	L	L1	L2	N	Kg
4	<a href="#">3300 04 00</a>	21	40.5	29.5	32	20	55	22	6	11	0.078
6	<a href="#">3300 06 00</a>	28	48	38.5	39	27.5	70	28	7.5	14	0.213
8	<a href="#">3300 08 00</a>	28	50	39	39	27.5	70	28	7.5	14	0.124

Clearance hole for Ø3 mm screw

## 3320 Multi-Connector Male Screw Body

Technical polymer, NBR

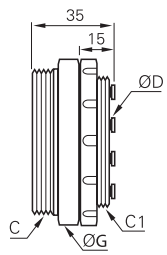

ØD	C	C1		Number of Outlets	G	Kg
4	M38x1.5	M32x1.5	<a href="#">3320 04 00 02</a>	2	42	0.046
	M46x1.5	M40x1.5	<a href="#">3320 04 00 04</a>	4	50	0.070
		M40x1.5	<a href="#">3320 04 00 07</a>	7	50	0.072
6	M65x1.5	M58x1.5	<a href="#">3320 04 00 12</a>	12	70	0.137
	M38x1.5	M32x1.5	<a href="#">3320 06 00 02</a>	2	42	0.050
		M46x1.5	M40x1.5	<a href="#">3320 06 00 04</a>	4	50
	M40x1.5		<a href="#">3320 06 00 07</a>	7	50	0.072
8	M38x1.5	M32x1.5	<a href="#">3320 08 00 02</a>	2	45	0.050

The number of male body outlets must correspond to the same number of outlets on the female body.

## 3321 Multi-Connector Female Screw Body

Technical polymer, NBR

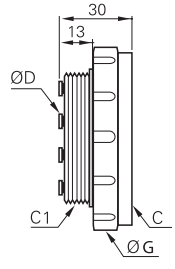

ØD	C	C1		Number of Outlets	G	Kg
4	M38x1.5	M32x1.5	<a href="#">3321 04 00 02</a>	2	45	0.040
	M46x1.5	M40x1.5	<a href="#">3321 04 00 04</a>	4	55	0.065
		M40x1.5	<a href="#">3321 04 00 07</a>	7	55	0.064
6	M65x1.5	M58x1.5	<a href="#">3321 04 00 12</a>	12	75	0.125
	M38x1.5	M32x1.5	<a href="#">3321 06 00 02</a>	2	45	0.043
		M46x1.5	M40x1.5	<a href="#">3321 06 00 04</a>	4	55
	M40x1.5		<a href="#">3321 06 00 07</a>	7	55	0.064
8	M38x1.5	M32x1.5	<a href="#">3321 08 00 02</a>	2	45	0.042

The number of female body outlets must correspond to the same number of outlets on the male body.

## 3329 Multi-Connector Screw Cap

Technical polymer

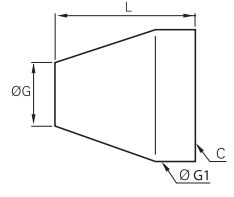

C		Number of Outlets	G	G1	L	Kg
M32x1.5	<a href="#">3329 00 01</a>	2	32	42	50	0.043
M40x1.5	<a href="#">3329 00 02</a>	4-7	35	50	55	0.058
M58x1.5	<a href="#">3329 00 03</a>	12	34	70	70	0.139

### Overall Dimensions for Bulkhead Mounting

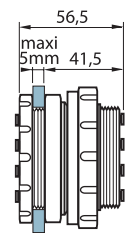
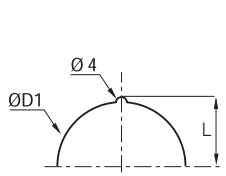

Number of Outlets	L	ØD1
2	17	32.5
4-7	21	40.5
12	30.3	58.5

# Modular Plug-In Connectors

## 3379 DIN Rail Connector for 2 Tubes

Technical polymer, NBR

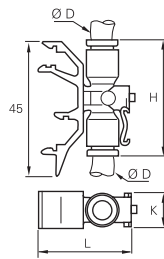

ØD		H	K	L	Kg
4	<a href="#">3379 04 00</a>	34.5	11	39.5	0.010
6	<a href="#">3379 06 00</a>	34.5	11	39.5	0.006
8	<a href="#">3379 08 00</a>	46	13	44.5	0.034

Start pressure test point on the system

## 3381 DIN Rail Connector for 3 Tubes

Technical polymer, NBR

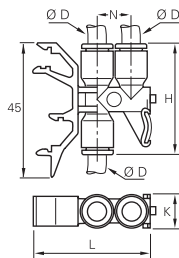

ØD		H	K	L	N	Kg
4	<a href="#">3381 04 00</a>	36.5	11	39.5	11.5	0.012
6	<a href="#">3381 06 00</a>	36.5	11	39.5	11.5	0.028
8	<a href="#">3381 08 00</a>	46	13	44.5	14.5	0.033

Start pressure test point on the system



# Self-Sealing and Oscillating Fittings

Parker Legris has developed these two **innovative** push-in fittings in order to integrate various functions and allow **quick installation** on pneumatic circuits.

## Product Advantages

### Self-Sealing Fittings

Prevents fluid flow when there is no tube connected  
Circuits may remain pressurised when being checked and maintained  
When connected, the compressed air flow is restored in both directions

### Oscillating Fittings

Rotation matched to cylinder rod stroke  
Prevents tube wear due to excessive flexing  
Optimum reliability and durability  
Simplifies circuit assembly



Robotics  
Automotive Process  
Pneumatics  
Semi-Conductors  
Textile  
Packaging

Applications

## Technical Characteristics

<b>Compatible Fluids</b>	Compressed air Other fluids: please consult us
<b>Working Pressure</b>	Vacuum to 20 bar (10 bar: self-sealing fitting)
<b>Working Temperature</b>	-20°C to +80°C

Reliable performance is dependent upon the type of fluid conveyed, component materials and tubing being used.  
Use is guaranteed with a vacuum of 755 mm Hg (99% vacuum).

### Component Materials

#### Swivel Fitting

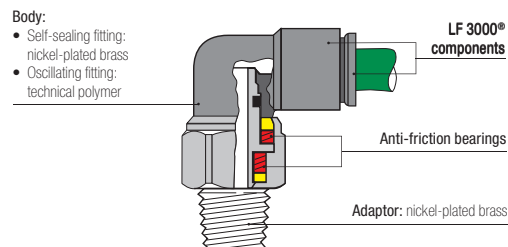

#### Silicone-free

### Regulations

ISO 14743: Pneumatic fluid power, push-in connectors for thermoplastic tubes  
DI: 97/23/EC (PED)

DI: 2002/95/EC (RoHS),  
2011/65/EC  
DI: 1907/2006 (REACH)

## Installation Configurations

### Self-Sealing Fitting

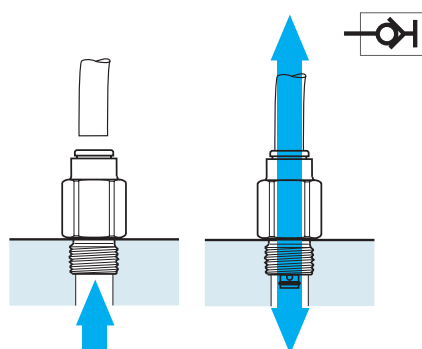

### Oscillating Fitting

Tube O.D. (mm)	Torque (daN.m)	Max. Rotation Speed (turn/min.)
4	<math>2.5 \cdot 10^{-3}</math>	190
6	<math>4 \cdot 10^{-3}</math>	160
8	<math>7 \cdot 10^{-3}</math>	120
10	<math>11 \cdot 10^{-3}</math>	90
12	<math>16 \cdot 10^{-3}</math>	80

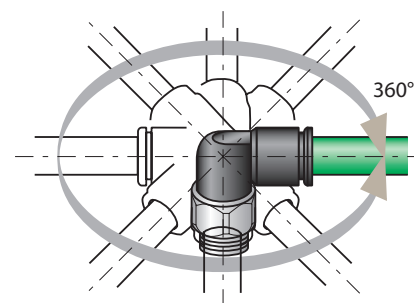



# Self-Sealing and Oscillating Fittings

## 3391 Self-Sealing Stud Fitting, Male BSPP Thread

Nickel-plated brass, NBR

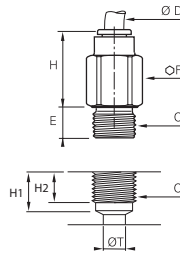

ØD	C		E	F	H	H1	H2	ØT	Kg
4	G1/8	<a href="#">3391 04 10</a>	5	13	18	7.5	6	5	0.017
6	G1/8	<a href="#">3391 06 10</a>	5	14	19.5	9	6	7.5	0.018
8	G1/8	<a href="#">3391 08 10</a>	5	14	29.5	10	6	7.5	0.025
	G1/4	<a href="#">3391 08 13</a>	5.5	16	25.5	11	8	9	0.032
10	G3/8	<a href="#">3391 10 17</a>	5.5	20	27.5	13	11	10	0.054

Maximum working pressure: 10 bar

## 3091 Self-Sealing Stud Fitting, Male BSPT Thread

Nickel-plated brass, NBR

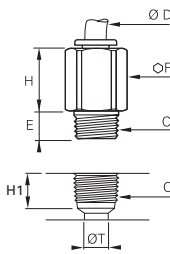

ØD	C		E	F	H	H1	ØT	Kg
4	R1/8	<a href="#">3091 04 10</a>	7.5	12	18	9.5	5	0.014
6	R1/8	<a href="#">3091 06 10</a>	7.5	13	19.5	9.5	7.5	0.015
8	R1/8	<a href="#">3091 08 10</a>	6.5	14	25	10.5	7.5	0.024
	R1/4	<a href="#">3091 08 13</a>	11	14	25.5	13.5	9	0.021
10	R3/8	<a href="#">3091 10 17</a>	11.5	17	27.5	14	10	0.035

Maximum working pressure: 10 bar

## 3160 Self-Sealing Plug-In Fitting

Technical polymer, NBR

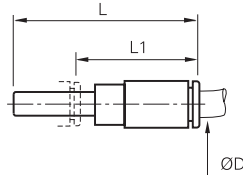

ØD		L	L1	Kg
4	<a href="#">3160 04 00</a>	46	33.5	0.006
6	<a href="#">3160 06 00</a>	53.5	31	0.009
8	<a href="#">3160 08 00</a>	58	31	0.014

## 3159 Oscillating Elbow, Male BSPT Thread

Technical polymer, nickel-plated brass, NBR

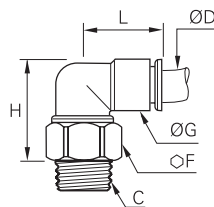

ØD	C		F	G	H	L	Kg
4	R1/8	<a href="#">3159 04 10</a>	12	11	22	17.5	0.013
	R1/8	<a href="#">3159 06 10</a>	14	14	26.5	20.5	0.020
6	R1/4	<a href="#">3159 06 13</a>	14	14	23.5	20.5	0.022
	R1/8	<a href="#">3159 08 10</a>	17	16	32	23.5	0.034
8	R1/4	<a href="#">3159 08 13</a>	17	16	29	23.5	0.034
	R3/8	<a href="#">3159 08 17</a>	17	16	25	23.5	0.031
10	R1/4	<a href="#">3159 10 13</a>	19	19.5	37.5	29	0.051
	R3/8	<a href="#">3159 10 17</a>	19	19.5	33.5	29	0.045
12	R1/4	<a href="#">3159 12 13</a>	21	22	44.5	33.5	0.074
	R3/8	<a href="#">3159 12 17</a>	21	22	41	33.5	0.067

Pre-coated thread

## 3189 Oscillating Elbow, Male BSPP and Metric Thread

Technical polymer, nickel-plated brass, NBR

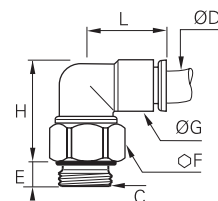

ØD	C		E	F	G	H	L	Kg
4	M5x0.8	<a href="#">3189 04 19</a>	3	12	11	24.5	17.5	0.012
	G1/8	<a href="#">3189 04 10</a>	5	13	11	23	17.5	0.014
	M5x0.8	<a href="#">3189 06 19</a>	3	12	14	27.5	20.5	0.017
6	G1/8	<a href="#">3189 06 10</a>	5	14	14	27	20.5	0.020
	G1/4	<a href="#">3189 06 13</a>	5.5	16	14	25.5	20.5	0.023
	G1/8	<a href="#">3189 08 10</a>	5	17	16	33.5	23.5	0.034
8	G1/4	<a href="#">3189 08 13</a>	5.5	17	16	31	23.5	0.032
	G3/8	<a href="#">3189 08 17</a>	5.5	20	16	29.5	23.5	0.039
	G1/4	<a href="#">3189 10 13</a>	5.5	19	19.5	39	29	0.053
10	G3/8	<a href="#">3189 10 17</a>	5.5	20	19.5	37	29	0.050
	G1/4	<a href="#">3189 12 13</a>	5.5	21	22	46.5	33.5	0.073
12	G3/8	<a href="#">3189 12 17</a>	5.5	21	22	45.5	33.5	0.071

# Accessories for Push-In Fittings

Parker Legris has designed these different accessories to improve **safety** and circuit **identification**.

## Product Advantages

**Safety** | Protection of operators and equipment  
Prevents accidental disconnection  
Disconnection only possible with tooling  
Resistance to grease and cleaning agents

**Ergonomic** | Colour-coding for fluid circuit identification (6 colours)  
Setting and fixing of your circuits thanks to clips and release button covers  
Easy disconnection with tool where access is difficult  
Adapted to meet all installation configurations



Robotics  
Automotive Process  
Pneumatics  
Semi-Conductors  
Textile  
Water Treatment  
Beverage Dispensers

Applications

## Technical Characteristics

<b>Compatible Ranges</b>	LF 3000®, LIQUIfit®
<b>Working Temperature</b>	-20°C to +95°C
<b>Component Materials</b>	Tamper-proof safety clip, release button cover, clip: technical polymer Reducer and plug: nickel-plated brass

## Installation Process

### Tamper-Proof Safety Clip



### Coloured Release Button Covers

Coloured release button covers can be mounted on LF 3000® and LIQUIfit® fittings, supplied fitted with manual release buttons.

5 colours are available and allows colour coding to be used throughout circuits.



### Disconnection Tool

In cases where access is difficult, this tool can be particularly useful.



### Clip Strips

Clips are also designed to fix LF 3000® fittings in series within a minimum of space.



The complete range of accessories can be found in Chapter 9.



# Accessories for Push-In Fittings

## 3130 Tamper-Proof Safety Clip

Technical polymer

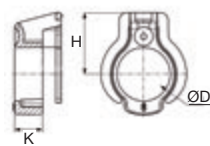

ØD							H	K	kg
4	<a href="#">3130 04 01</a>	<a href="#">3130 04 02</a>	<a href="#">3130 04 03</a>	<a href="#">3130 04 04</a>	<a href="#">3130 04 05</a>	<a href="#">3130 04 10</a>	6.6	3	0.001
6	<a href="#">3130 06 01</a>	<a href="#">3130 06 02</a>	<a href="#">3130 06 03</a>	<a href="#">3130 06 04</a>	<a href="#">3130 06 05</a>	<a href="#">3130 06 10</a>	7.8	3.1	0.001
8	<a href="#">3130 08 01</a>	<a href="#">3130 08 02</a>	<a href="#">3130 08 03</a>	<a href="#">3130 08 04</a>	<a href="#">3130 08 05</a>	<a href="#">3130 08 10</a>	9.5	4.3	0.001
10	<a href="#">3130 10 01</a>	<a href="#">3130 10 02</a>	<a href="#">3130 10 03</a>	<a href="#">3130 10 04</a>	<a href="#">3130 10 05</a>	<a href="#">3130 10 10</a>	10.8	4.2	0.002
12	<a href="#">3130 12 01</a>	<a href="#">3130 12 02</a>	<a href="#">3130 12 03</a>	<a href="#">3130 12 04</a>	<a href="#">3130 12 05</a>	<a href="#">3130 12 10</a>	12.5	5.1	0.003
14	<a href="#">3130 14 01</a>	<a href="#">3130 14 02</a>	<a href="#">3130 14 03</a>	<a href="#">3130 14 04</a>	<a href="#">3130 14 05</a>	<a href="#">3130 14 10</a>	15	6	0.004

## CLIP Clip Strip for Tubes and Fittings

Technical polymer

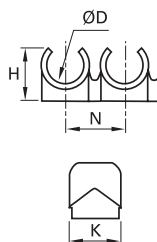

ØD		Number of Outlets	H	K	N	Kg
4	<a href="#">CLIP 04 00</a>	8	9	13.5	10.5	0.007
6	<a href="#">CLIP 06 00</a>	8	10.5	13	10.5	0.008
8	<a href="#">CLIP 08 00</a>	7	12.5	10.5	12	0.007
10	<a href="#">CLIP 10 00</a>	6	14	12	15	0.005
12	<a href="#">CLIP 12 00</a>	5	16.5	14	16.5	0.009
14	<a href="#">CLIP 14 00</a>	4	18	16	20.5	0.009

Delivered in boxes of 10 strips of the same diameter (complete with self-tapping screws of 95 mm length). These clips can be used with metric or inch tubing.

## 3000 70 Dismounting Tool

Treated steel

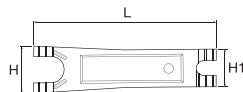

	H	H1	L	Kg
<a href="#">3000 70 00</a>	25	20	96	0.021

For dismantling LF 3000® tubing/fittings where access is difficult, we recommend the use of this dismantling tool.

## 3110 Coloured Release Button Covers

Technical polymer



ØD						kg
4	<a href="#">3110 04 00</a>	<a href="#">3110 04 02</a>	<a href="#">3110 04 03</a>	<a href="#">3110 04 04</a>	<a href="#">3110 04 05</a>	0.001
6	<a href="#">3110 06 00</a>	<a href="#">3110 06 02</a>	<a href="#">3110 06 03</a>	<a href="#">3110 06 04</a>	<a href="#">3110 06 05</a>	0.001
8	<a href="#">3110 08 00</a>	<a href="#">3110 08 02</a>	<a href="#">3110 08 03</a>	<a href="#">3110 08 04</a>	<a href="#">3110 08 05</a>	0.001
10	<a href="#">3110 10 00</a>	<a href="#">3110 10 02</a>	<a href="#">3110 10 03</a>	<a href="#">3110 10 04</a>	<a href="#">3110 10 05</a>	0.001
12	<a href="#">3110 12 00</a>	<a href="#">3110 12 02</a>	<a href="#">3110 12 03</a>	<a href="#">3110 12 04</a>	<a href="#">3110 12 05</a>	0.001
14	<a href="#">3110 14 00</a>	<a href="#">3110 14 02</a>	<a href="#">3110 14 03</a>	<a href="#">3110 14 04</a>	<a href="#">3110 14 05</a>	0.002

## 0178 Reducer, Male/Female BSPP and Metric Thread

Nickel-plated brass, NBR

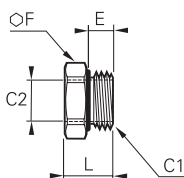

C1	C2		E	F	L	Kg
M7x1	M5x0.8	<a href="#">0178 55 19</a>	5	10	12	0.005
G1/8	M5x0.8	<a href="#">0178 10 19</a>	5	13	9	0.005
G1/4	G1/8	<a href="#">0178 13 10</a>	5.5	16	9.5	0.006
G3/8	G1/8	<a href="#">0178 17 10</a>	5.5	20	10.5	0.016
	G1/4	<a href="#">0178 17 13</a>	5.5	20	10.5	0.011
G1/2	G1/4	<a href="#">0178 21 13</a>	7.5	24	12.5	0.024
	G3/8	<a href="#">0178 21 17</a>	7.5	24	12.5	0.016
G3/4	G1/2	<a href="#">0178 27 21</a>	7.5	32	13.5	0.035

With integrated O-ring seal

## 0222 Internal Hex Plug, Male BSPP and Metric Thread

Nickel-plated brass, NBR

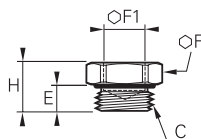

C		E	F	F1	H	Kg
M5x0.8	<a href="#">0222 19 00</a>	3.5	8	2.5	7	0.002
M7x1	<a href="#">0222 55 00</a>	5	10	3	8.5	0.003
G1/8	<a href="#">0222 10 00</a>	5	13	5	8.5	0.006
G1/4	<a href="#">0222 13 00</a>	5.5	16	6	9.5	0.010
G3/8	<a href="#">0222 17 00</a>	5.5	20	8	10.5	0.019
G1/2	<a href="#">0222 21 00</a>	7.5	24	10	12	0.031

With integrated O-ring seal



# LF 3200 (3 mm) Push-In Fittings Range

## Stud Fittings

- 3281**  
Metric  
Page 1-41
- 3299**  
Metric  
Page 1-41
- 3229**  
Metric  
Page 1-41
- 3298**  
Metric  
Page 1-41
- 3293**  
Metric  
Page 1-41
- 3218**  
Metric  
Page 1-42



## Tube-to-Tube Fittings and Accessories

- 3206**  
Straight  
Page 1-43
- 3202**  
Elbow  
Page 1-43
- 3204**  
Tee  
Page 1-43
- 3266**  
Reducer  
Page 1-43
- 3226**  
Plug  
Page 1-43



# LF 3200 Push-In Fittings (3 mm)

Miniature pneumatic installations are very precise and sensitive systems, having specific operating characteristics. Consequently, Parker Legris has developed this **ergonomic** range of brass push-in fittings for its **mechanical robustness** and **compactness**.

## Product Advantages

<b>Compact &amp; Lightweight</b>	25% smaller than other fittings on the market for optimum actuator dimensions Minimum weight for maximum efficiency Reduces energy consumption and limits actuator wear
<b>Resistance &amp; Performance</b>	All brass components for excellent impact resistance Gripping system with collet for increased robustness and service life Excellent resistance to high operating pressures
<b>Reliability</b>	100% leak-tested in production Date coding to guarantee quality and traceability Ideal for very sensitive applications Corrosion-resistant



**Applications**  
Pneumatic Panels  
Robotics  
Semi-Conductors  
Textile  
Pneumatics  
Vacuum

## Technical Characteristics

<b>Compatible Fluids</b>	Compressed air
<b>Working Pressure</b>	Vacuum to 20 bar
<b>Working Temperature</b>	-15°C to +80°C
<b>Tightening Torque (daN.m)</b>	0.01 to 0.1

Reliable performance is dependent upon the type of fluid conveyed, component materials and tubing being used.  
Use is guaranteed with a vacuum of 755 mm Hg (99% vacuum).

### Component Materials

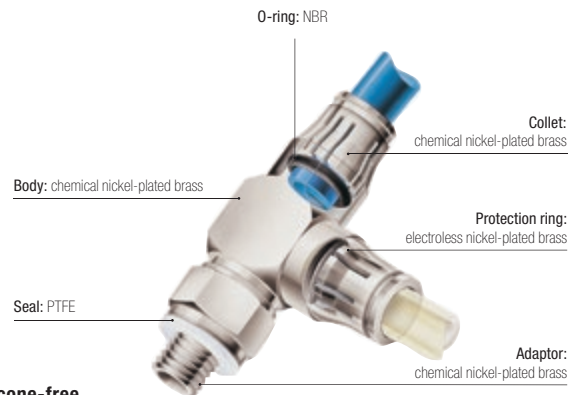

**Silicone-free**

### Regulations

**ISO 14743** ISO 14743: Pneumatic fluid power, push-in connectors for thermoplastic tubes

**DI:** 97/23/EC (PED)

**DI:** 2002/95/EC (RoHS), 2011/65/EC

**DI:** 94/9/EC (ATEX)

**RG:** 1907/2006 (REACH)

## Installation Configurations

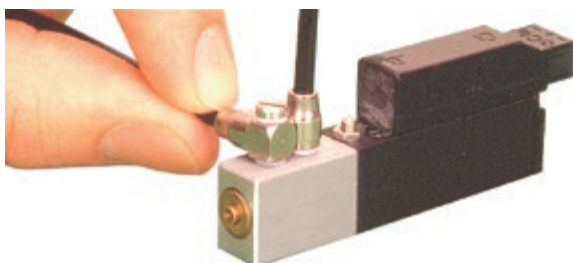

The LF 3200 fitting, connected with a 3 mm polyurethane or antistatic polyurethane tube, is the perfect solution for compact installations:

- which are highly stressed
- whose reliability is critical

# Stud Fittings

## 3281 Stud Fitting, Male Metric Thread

Nickel-plated brass, NBR

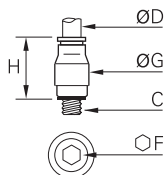

ØD	C		F	G	H	Kg
3	M3x0.5	<a href="#">3281 03 09</a>	1.5	6	9.5	0.001
	M5x0.8	<a href="#">3281 03 19</a>	1.5	8	9.5	0.002

## 3299 Compact Stud Elbow, Male Metric Thread

Nickel-plated brass, NBR

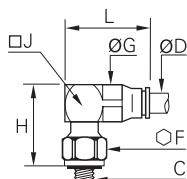

ØD	C		F	G	H	J	L	Kg
3	M3x0.5	<a href="#">3299 03 09</a>	6	6	13.5	6	13.5	0.004
	M5x0.8	<a href="#">3299 03 19</a>	8	6	13	6	13.5	0.005

## 3229 Extended Stud Elbow, Male Metric Thread

Nickel-plated brass, NBR

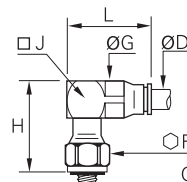

ØD	C		F	G	H	J	L	Kg
3	M3x0.5	<a href="#">3229 03 09</a>	6	6	16	6	13.5	0.004
	M5x0.8	<a href="#">3229 03 19</a>	8	6	17	6	13.5	0.005

## 3298 Stud Branch Tee, Male Metric Thread

Nickel-plated brass, NBR

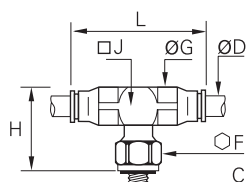

ØD	C		F	G	H	J	L	Kg
3	M3x0.5	<a href="#">3298 03 09</a>	6	6	13.5	6	20.5	0.004
	M5x0.8	<a href="#">3298 03 19</a>	8	6	13	6	20.5	0.005

## 3293 Stud Run Tee, Male Metric Thread

Nickel-plated brass, NBR

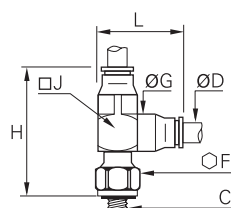

ØD	C		F	G	H	J	L	Kg
3	M3x0.5	<a href="#">3293 03 09</a>	6	6	20	6	13.5	0.004
	M5x0.8	<a href="#">3293 03 19</a>	8	6	20	6	13.5	0.005

# Stud Fittings

## 3218 Single Banjo, Male Metric Thread

Nickel-plated brass, NBR

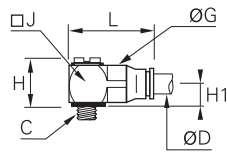

ØD	C		G	H	H1	J	L	Kg
3	M3x0.5	<a href="#">3218 03 09</a>	6	9.5	4	6	12.5	0.002
	M5x0.8	<a href="#">3218 03 19</a>	6	10.5	4.5	8	15	0.005



# Tube-to-Tube Fittings and Accessories

## 3206 Equal Tube/Tube Connector

Nickel-plated brass, NBR

ØD		G	L	Kg
3	 3206 03 00	6	17	0.002

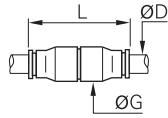

## 3202 Equal Elbow

Nickel-plated brass, NBR

ØD		G	J	L	Kg
3	 3202 03 00	6	6	13.5	0.003

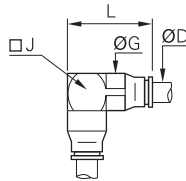

## 3204 Equal Tee

Nickel-plated brass, NBR

ØD		G	H	J	L	L1	Kg
3	 3204 03 00	6	13.5	6	20.5	10.5	0.004

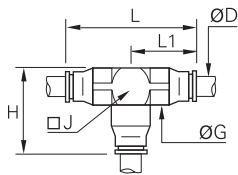

## 3266 Plug-In Reducer

Nickel-plated brass, NBR, technical polymer

ØD	ØD1		G	L	L1	Kg
3	4	 3266 03 04	6	28	19	0.001

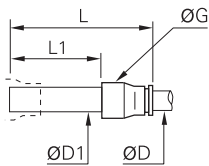

## 3226 Blanking Plug

Nickel-plated brass

ØD		L	L1	Kg
3	 3226 03 00	20	10	0.001

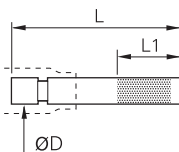

# Range of LIQUIfit® Push-In Fittings

## Stud Fittings

### Straights

**6505**  
BSPT  
Page 1-48



**6315**  
BSPT  
Page 1-48



**6353**  
BSPP  
Page 1-49



**6521**  
BSPT  
Page 1-50



### Straights - Inch

**6505**  
BSPT/NPTF  
Page 1-48



**6315**  
NPTF  
Page 1-49



**6353**  
BSPP  
Page 1-49



**6352**  
BSPP  
Page 1-49



**6325**  
UNS  
Page 1-49



**6521**  
BSPT/NPTF  
Page 1-50



### Carstick®

**6300**  
Page 1-50



### Carstick® - Inch

**6300**  
Page 1-50



### Elbows

**6579**  
BSPT  
Page 1-51



**6509**  
BSPT  
Page 1-51



### Elbows - Inch

**6579**  
BSPT/NPTF  
Page 1-51



**6509**  
BSPT/NPTF  
Page 1-52



### Tees

**6508**  
BSPT  
Page 1-52



**6503**  
BSPT  
Page 1-53



### Tees - Inch

**6508**  
BSPT/NPTF  
Page 1-53



**6503**  
BSPT/NPTF  
Page 1-53



### Plugs

**6355**  
BSPT  
Page 1-53



## Tube-to-Tube Fittings

### Straight

**6306**  
Page 1-54



### Straight - Inch

**6306**  
Page 1-54



### Elbow

**6302**  
Page 1-54



### Elbow - Inch

**6302**  
Page 1-54



### Tee

**6304**  
Page 1-55



### Tee - Inch

**6304**  
Page 1-55



### Y

**6340**  
Page 1-55



### Y - Inch

**6340**  
Page 1-55



### Cross

**6307**  
Page 1-56



### Cross - Inch

**6307**  
Page 1-56



## Bulkhead Connectors

### Straight

**6316**  
Page 1-56



### Straight - Inch

**6316**  
Page 1-56



## Plug-In Fittings and Accessories

### Elbows

**6382**  
Page 1-57



**6380**  
Page 1-57



**6382**  
Page 1-57



### Tees

**6383**  
Page 1-57



**6388**  
Page 1-57



**6388**  
Page 1-58



### Tee - Inch

### Accessories

**6366**  
Page 1-58



**6326**  
Page 1-58



**6322**  
Page 1-59



**6351**  
Page 1-59



### Accessories - Inch

**6366**  
Page 1-58



**6368**  
Page 1-58



**6326**  
Page 1-59



**6322**  
Page 1-59



**6351**  
Page 1-59



# Range of LIQUIfit+ Push-In Fittings

Stud Fittings		Tube-to-Tube Fittings		Plug-In Fittings
Straight - Inch		Straight - Inch	Elbow - Inch	Elbow - Inch
<b>6333</b> BSPP Page 1-63		<b>6336</b> BSPP Page 1-63	<b>6332</b> BSPP Page 1-63	<b>6331</b> BSPP Page 1-63
				

LIQUIfit® and LIQUIfit+ Accessories		
<b>3130</b> Page 1-60	<b>3110</b> Page 1-60	<b>0605</b> Page 1-60
		

# Range of LIQUIfit® Push-In Fittings with Metal Adaptor

Stud Fittings with Stainless Steel Adaptor							
Straights		Elbows		Tees			
<b>6911</b> BSPP Page 1-65	<b>6975</b> BSPT Page 1-65	<b>6959</b> BSPP Page 1-65	<b>6979</b> BSPT Page 1-66	<b>6958</b> BSPP Page 1-66	<b>6978</b> BSPT Page 1-66	<b>6953</b> BSPP Page 1-67	<b>6973</b> BSPT Page 1-67
							

Stud Fittings with Nickel-Plated Brass Adaptor							
Straights		Elbows		Tees			
<b>6901</b> BSPP Page 1-68	<b>6905</b> BSPT Page 1-68	<b>6999</b> BSPP Page 1-68	<b>6909</b> BSPT Page 1-69	<b>6998</b> BSPP Page 1-69	<b>6908</b> BSPT Page 1-69	<b>6993</b> BSPP Page 1-70	<b>6903</b> BSPT Page 1-70
							

## Part Number Construction

Example: 6505 08 17WP2

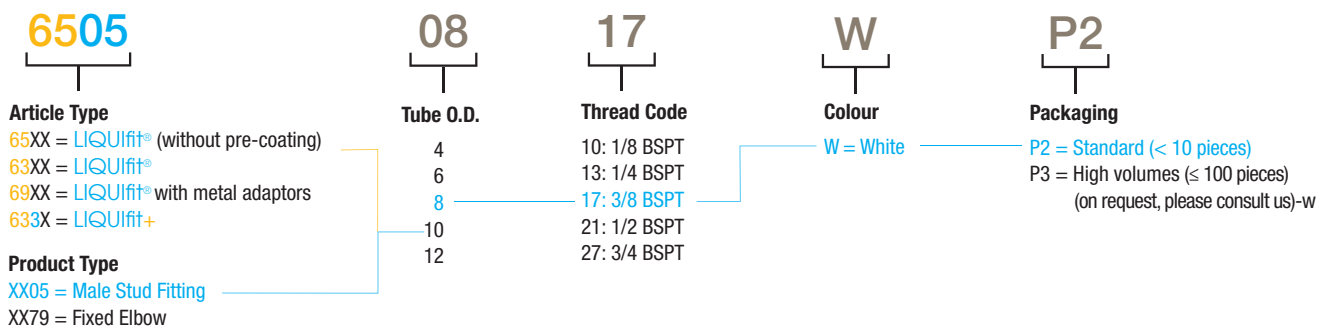

# LIQUIfit® Push-In Fittings

This "eco-designed" range proposes an **innovative alternative** for water applications; **no fluid contamination** occurs and **environmental protection is guaranteed**. These fittings ensure **reliable and compact** connections for **liquid transfer** applications.

## Product Advantages

### Innovative Technology & Concept

- Ergonomic and aesthetic design
- The most compact product on the market for water, beverages and liquid foodstuffs
- Easy-to-clean external surfaces
- Push-in connection and disconnection
- Full flow
- Use with a pre-prepared metallic tubing
- Gripping system preventing any pumping effect
- Eco-designed (materials, manufacturing process, weight, dimensions and performance)

### Optimal Performance

- Patented sealing technology
- 100% leak-tested in production
- Date coding to guarantee quality and traceability
- Wide range of shapes and numerous configurations

### High Performance Material

- Bio-sourced polymer meeting the most severe food process regulations
- Suitable for contact with water and beverages
- Excellent chemical and mechanical resistance, even at high temperature
- Free of bisphenol A and phtalates, conforming with regulations



Hot & Cold Drinks Dispensers  
Neutral Gases  
Cooling Systems  
Food Process  
Water Purification Systems  
Water Dispensers  
Medical

Applications

## Technical Characteristics

<b>Compatible Fluids</b>	Water, beverages, CO <sub>2</sub> (inert use) Chemical fluids: please consult us		
<b>Working Pressure</b>	Vacuum to 16 bar		
<b>Working Temperature</b>	-10°C to +95°C		
<b>Tightening Torques (BSPT/NPTF)</b>	Thread	1/8" and 1/4"	3/8" and 1/2"
	daN.m	0.15	0.30

Reliable performance is dependent upon the type of fluid conveyed, component materials and tubing being used.  
Use is guaranteed with a vacuum of 755 mm Hg (99% vacuum).

### Component Materials

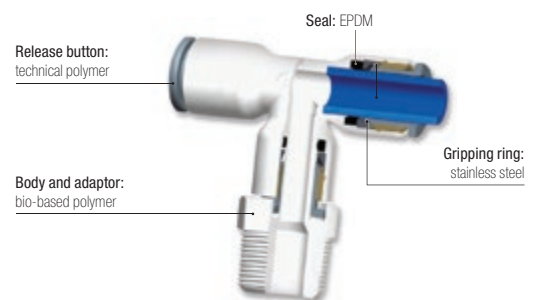

Silicone-free

### Regulations

DI: 2002/95/EC (RoHS), 2011/65/EC	DM 174
RG: 1935/2004/EC	WRAS
RG: 1907/2006 (REACH)	ACS
FDA: 21 CFR	
NSF 51 at 95°C	
NSF/ANSI 61 - C HOT	

# Pressure and Temperature of the Different Diameters and Related Products of the LIQUIfit® Range

-10°C		Pressure (bar)	
mm Ø	inch Ø	Fittings	Tubing
4	5/32	16	16
6	1/4	16	16
8	5/16	16	16
10	3/8	13	15
12	1/2	11	11

+1°C		Pressure (bar)	
mm Ø	inch Ø	Fittings	Tubing
4	5/32	16	16
6	1/4	16	16
8	5/16	16	16
10	3/8	13	15
12	1/2	11	11

+20°C		Pressure (bar)	
mm Ø	inch Ø	Fittings	Tubing
4	5/32	16	16
6	1/4	16	16
8	5/16	16	16
10	3/8	13	15
12	1/2	11	11

+40°C		Pressure (bar)	
mm Ø	inch Ø	Fittings	Tubing
4	5/32	16	16
6	1/4	16	16
8	5/16	16	16
10	3/8	13	15
12	1/2	11	11

+65°C		Pressure (bar)	
mm Ø	inch Ø	Fittings	Tubing
4	5/32	10	10
6	1/4	10	10
8	5/16	10	10
10	3/8	7	7
12	1/2	7	7

+95°C		Pressure (bar)	
mm Ø	inch Ø	Fittings	Tubing
4	5/32	4	4
6	1/4	4	4
8	5/16	4	4
10	3/8	4	4
12	1/2	4	4

## Environmental Footprint

Example: representation of the environmental footprint of an equal tube-to-tube connector

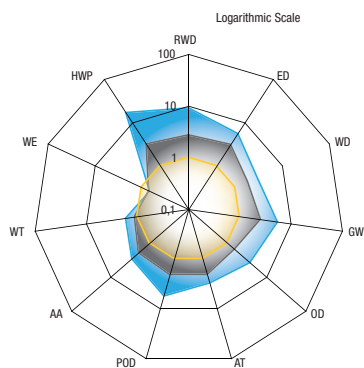

**Tube-to-Tube Connector**  
 ■ Market Standard in POM  
 ■ Market Standard in PP  
 ■ Parker Legris

## LIQUIfit® Tube-to-Tube Connector



## Market Standard Tube-to-Tube Connector

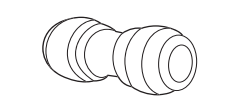

RWD: Raw Material Depletion  
 ED: Energy Depletion  
 WD: Water Depletion  
 GW: Global Warming  
 OZ: Ozone Depletion  
 AT: Air Toxicity

POC: Photochemical Ozone Creation  
 AA: Air Acidification  
 WT: Water Toxicity  
 WE: Water Eutrophication  
 HWP: Hazardous Waste Production

## Environmental Approach

The Life Cycle Analysis (LCA) offers a true alternative in terms of environmental differentiation.

We carried out a comparative LCA on the market of drinking water between 3 Parker Legris fittings and the standard products on the market.

This analysis relies on ISO 14020, ISO 14025 and IEC PAS 62545 standards and the results are presented in a report approved by an ethics committee (Bureau Veritas).



## Sealing Profile for Female Thread Stud Fitting

Stud Fitting,  
Female NPTF Thread  
6315

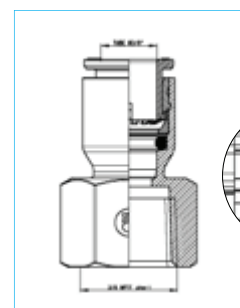

Stud Fitting Flat Type,  
Female BSPP Thread,  
6352 and 6333

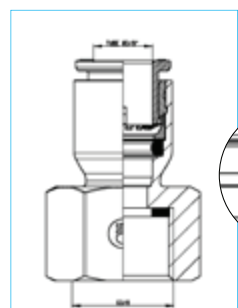

Tap Connector Cone Type,  
Female BSPP Thread,  
6353

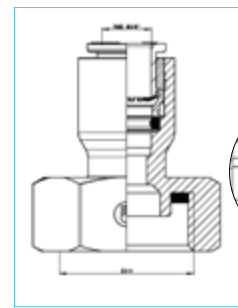

# Stud Fittings

## 6505 Stud Fitting, Male BSPT Thread



Bio-based polymer, EPDM

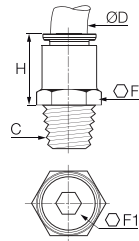

ØD	C			F	F1	H	kg
4	R1/8	6505 04 10WP2		11	3	18	0.003
	R1/4	6505 04 13WP2		14	3	18	0.004
6	R1/8	6505 06 10WP2	6505 06 10WP3	11	4	18	0.002
	R1/4	6505 06 13WP2	6505 06 13WP3	14	4	18	0.004
8	R1/8	6505 08 10WP2	6505 08 10WP3	17	6	20	0.004
	R1/4	6505 08 13WP2	6505 08 13WP3	14	6	20	0.004
	R3/8	6505 08 17WP2	6505 08 17WP3	17	6	20	0.005
10	R1/4	6505 10 13WP2	6505 10 13WP3	17	7	21.5	0.005
	R3/8	6505 10 17WP2	6505 10 17WP3	19	7	21.5	0.007
12	R1/2	6505 10 21WP2		22	7	21.5	0.010
	R3/8	6505 12 17WP2	6505 12 17WP3	19	9	24.5	0.008
	R1/2	6505 12 21WP2	6505 12 21WP3	22	9	24.5	0.012

WP3 = high volumes (number of parts per bag: 40, 50 or 100, depending on the diameters)  
Thread without pre-coating

## 6505 Stud Fitting, Male NPTF Thread



Inch

Bio-based polymer, EPDM

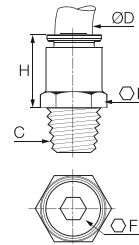

ØD	C			F	F1	H	kg
1/4	NPT1/8	6505 56 11WP2		1/2	5/32	17	0.002
	NPT1/4	6505 56 14WP2	6505 56 14WP3	9/16	5/32	17	0.003
3/8	NPT1/4	6505 60 14WP2		3/4	1/4	22	0.006
	NPT3/8	6505 60 18WP2		3/4	1/4	22	0.007
1/2	NPT3/8	6505 62 18WP2		15/16	3/8	28	0.012
	NPT1/2	6505 62 22WP2		15/16	3/8	28	0.013

WP3 = high volumes (number of parts per bag: 40, 50 or 100, depending on the diameters)  
Thread without pre-coating

## 6505 Stud Fitting, Male BSPT Thread



Inch

Bio-based polymer, EPDM

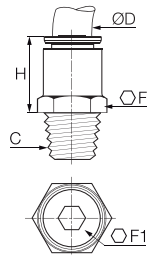

ØD	C			F	F1	H	kg
1/4	R1/8	6505 56 10WP2		11	5	17	0.002
	R1/4	6505 56 13WP2		14	5	17	0.003
3/8	R1/4	6505 60 13WP2		17	7	22	0.006
	R3/8	6505 60 17WP2		19	7	22	0.006
1/2	R1/2	6505 60 21WP2		22	7	28	0.012
	R3/8	6505 62 17WP2		24	9	28	0.014
	R1/2	6505 62 21WP2		24	9	28	0.017

Thread without pre-coating.  
5/32" (4mm) and 5/16" (8mm) also available.

## 6315 Stud Connector, Female BSPT Thread



Bio-based polymer, EPDM

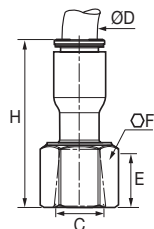

ØD	C			E	F	H	kg
6	R1/8	6315 06 10WP2		11	13	32	0.003
	R1/4	6315 06 13WP2	6315 06 13WP3	14	16	33	0.004
8	R1/4	6315 08 13WP2	6315 08 13WP3	14	16	33.5	0.004
	R3/8	6315 08 17WP2	6315 08 17WP3	14	20	36	0.009

WP3 = high volumes (number of parts per bag: 40, 50 or 100, depending on the diameters).



# Stud Fittings

## 6315 Stud Fitting, Female NPTF Thread



Bio-based polymer, EPDM

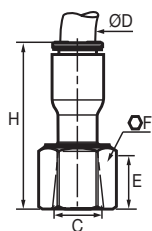

ØD	C		F	H	kg
1/4	NPT1/4	<a href="#">6315 56 14WP2</a>	11/16	30	0.003
3/8	NPT3/8	<a href="#">6315 60 18WP2</a>	13/16	36	0.007

See sealing profile page 1-47.

## 6353 Tap Connector Cone Type, Female BSPP Thread



Bio-based polymer, EPDM

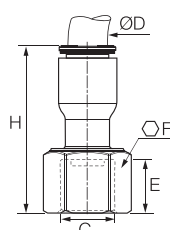

ØD	C		E	F	H	kg
6	G3/4	<a href="#">6353 06 27WP2</a>	10	32	32	0.011
8	G3/4	<a href="#">6353 08 27WP2</a>	10	32	40.5	0.017
10	G1/2	<a href="#">6353 10 21WP2</a>	12	27	36	0.011

See sealing profile page 1-47.

## 6353 Tap Connector Cone Type, Female BSPP Thread



Bio-based polymer, EPDM

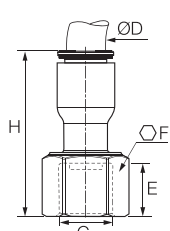

ØD	C		E	F	H	kg
1/4	G3/4	<a href="#">6353 56 27WP2</a>	10	32	31	0.006
3/8	G1/2	<a href="#">6353 60 21WP2</a>	12	27	36	0.011
	G3/4	<a href="#">6353 60 27WP2</a>	10	32	41	0.018
1/2	G3/4	<a href="#">6353 62 27WP2</a>	10	32	44.5	0.014

See sealing profile page 1-47.

## 6352 Stud Fitting Flat Type, Female BSPP Thread



Bio-based polymer, EPDM

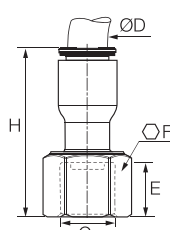

ØD	C		E	F	H	kg
8	G1/2	<a href="#">6352 08 21WP2</a>	10.5	27	35.5	0.009
	G5/8	<a href="#">6352 08 23WP2</a>	10.5	29	32	0.013
3/8	G3/8	<a href="#">6352 60 17WP2</a>	12	22	36	0.008
	G1/2	<a href="#">6352 60 21WP2</a>	12	27	36	0.011
1/2	G5/8	<a href="#">6352 62 23WP2</a>	10.5	29	35.5	0.013

See sealing profile page 1-47.

## 6325 Faucet Connector, Female UNS Thread



Bio-based polymer, EPDM

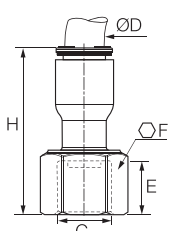

ØD	C		E	F	H	kg
1/4	UNS7/16-24	<a href="#">6325 56 133WP2</a>	7	9/16	31	0.002
3/8	UNS7/16-24	<a href="#">6325 60 133WP2</a>	7	9/16	32	0.004

See sealing profile page 1-47.

# Stud Fittings

## 6521 Stud Standpipe, Male BSPT Thread



Bio-based polymer

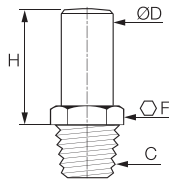

ØD	C		F	H	kg
6	R1/8	6521 06 10WP2	13	19	0.002
	R1/4	6521 06 13WP2	14	19	0.003
	R3/8	6521 06 17WP2	17	19	0.004
8	R1/8	6521 08 10WP2	19	23	0.003
	R1/4	6521 08 13WP2	19	23	0.004
	R3/8	6521 08 17WP2	19	23	0.004
10	R1/4	6521 10 13WP2	19	25	0.004
	R3/8	6521 10 17WP2	19	25	0.005
	R1/2	6521 10 21WP2	22	25	0.008
12	R3/8	6521 12 17WP2	22	28	0.005
	R1/2	6521 12 21WP2	22	28	0.007

Thread without pre-coating.

## 6521 Stud Standpipe, Male NPTF Thread



Inch

Bio-based polymer

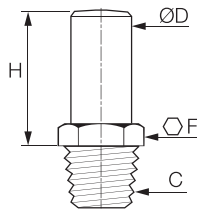

ØD	C		F	H	kg
1/4	NPT1/8	6521 56 11WP2	1/2	19	0.001
	NPT1/4	6521 56 14WP2	1/2	19	0.002
	NPT3/8	6521 56 18WP2	3/4	19.5	0.004
3/8	NPT1/4	6521 60 14WP2	3/4	25	0.004
	NPT3/8	6521 60 18WP2	3/4	25	0.004
1/2	NPT3/8	6521 62 18WP2	15/16	31	0.010
	NPT1/2	6521 62 22WP2	15/16	32.5	0.013

Thread without pre-coating.

## 6521 Stud Standpipe, Male BSPT Thread



Inch

Bio-based polymer

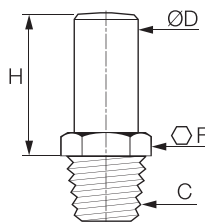

ØD	C		F	H	kg
1/4	R1/8	6521 56 10WP2	14	19	0.001
	R1/4	6521 56 13WP2	14	19	0.002
	R3/8	6521 56 17WP2	17	19	0.004
3/8	R1/4	6521 60 13WP2	19	25	0.004
	R3/8	6521 60 17WP2	19	25	0.004
1/2	R3/8	6521 62 17WP2	24	31.5	0.006
	R1/2	6521 62 21WP2	24	31.5	0.009

Thread without pre-coating. 5/16" (8mm) also available.

## 6300 LIQUIfit® Cartridge



Brass, EPDM

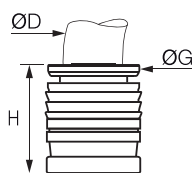

ØD		G	G1	H	L	kg
4	6300 04 00	8	11	10	554	0.002
6	6300 06 00	10	14.5	11.5	629	0.002
8	6300 08 00	13	15	15	794	0.003
10	6300 10 00	15.5	19.5	17	930	0.005
12	6300 12 00	18.5	21	19.5	1038	0.010

50 cartridges per Carstick®



## 6300 LIQUIfit® Cartridge



Inch

Brass, EPDM

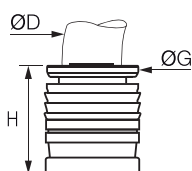

ØD		G	G1	H	L	kg
1/4	6300 56 00	10.5	14.5	12.5	600	0.002
3/8	6300 60 00	15.5	19	17	930	0.005
1/2	6300 62 00	22	25	23	1038	0.011

50 cartridges per Carstick®  
5/32" (4 mm) and 5/16" (8 mm) also available.



# Stud Fittings

## 6579 Fixed Elbow, Male BSPT Thread



Bio-based polymer, EPDM

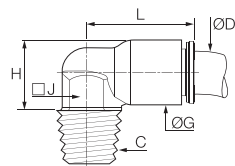

ØD	C		G	H	J	L	kg
6	R1/8	<a href="#">6579 06 10WP2</a>	11	14	10	19	0.002
	R1/4	<a href="#">6579 06 13WP2</a>	11	14	10	19	0.003
	R3/8	<a href="#">6579 06 17WP2</a>	11	14	10	19	0.004

Thread without pre-coating.

## 6579 Fixed Elbow, Male NPTF Thread



Bio-based polymer, EPDM

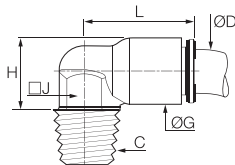

ØD	C		G	H	J	L	kg
1/4	NPT1/8	<a href="#">6579 56 11WP2</a>	11	22	3/8	18	0.009
	NPT1/4	<a href="#">6579 56 14WP2</a>	11	26	3/8	18	0.003
	NPT3/8	<a href="#">6579 56 18WP2</a>	11	26.5	3/8	18	0.004
3/8	NPT1/4	<a href="#">6579 60 14WP2</a>	16	32	1/2	26	0.006
	NPT3/8	<a href="#">6579 60 18WP2</a>	16	32	1/2	26	0.006

Thread without pre-coating.

## 6579 Fixed Elbow, Male BSPT Thread



Bio-based polymer, EPDM

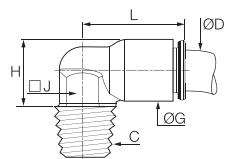

ØD	C		G	H	J	L	kg
1/4	R1/8	<a href="#">6579 56 10WP2</a>	11	22	10	18	0.002
	R1/4	<a href="#">6579 56 13WP2</a>	11	26	10	18	0.003
	R3/8	<a href="#">6579 56 17WP2</a>	11	26	10	18	0.004
3/8	R1/4	<a href="#">6579 60 13WP2</a>	16	31.5	13	26	0.006
	R3/8	<a href="#">6579 60 17WP2</a>	16	32	13	26	0.006

Thread without pre-coating.

## 6509 Stud Elbow, Male BSPT Thread



Bio-based polymer, EPDM

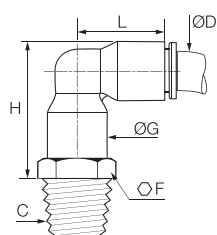

ØD	C		F	G	H	L	kg	
6	R1/8	<a href="#">6509 06 10WP2</a>	13	10.5	28	24	0.037	
	R1/4	<a href="#">6509 06 13WP2</a>	14	10.5	28	24	0.007	
	R3/8	<a href="#">6509 06 17WP2</a>	17	10.5	28	24	0.008	
8	R1/8	<a href="#">6509 08 10WP2</a>	19	13.5	34	29.5	0.010	
	R1/4	<a href="#">6509 08 13WP2</a>	<a href="#">6509 08 13WP3</a>	19	13.5	34	29.5	0.011
	R3/8	<a href="#">6509 08 17WP2</a>	19	13.5	34	29.5	0.011	
10	R1/4	<a href="#">6509 10 13WP2</a>	19	16	38	34.5	0.019	
	R3/8	<a href="#">6509 10 17WP2</a>	19	16	38	34.5	0.020	
12	R1/2	<a href="#">6509 10 21WP2</a>	22	16	38	34.5	0.023	
	R3/8	<a href="#">6509 12 17WP2</a>	22	19	44	40	0.022	
	R1/2	<a href="#">6509 12 21WP2</a>	22	19	44	40	0.024	

WP3 = high volumes (number of parts per bag: 40, 50 or 100, depending on the diameters)  
Thread without pre-coating, the body swivels for positioning purposes.

## Complementary LIQUIFIT® Range Products

The other LIQUIFIT® range products are presented in the corresponding chapters of this catalogue:

### Technical Tubing and Hose

#### Advanced PE

P. 3-26



### Function Fittings

#### Non-Return Valves

P. 4-44



### Industrial Ball Valves

#### LIQUIFIT® Ball Valves

P. 6-34



# Stud Fittings

## 6509 Stud Elbow, Male NPTF Thread



Bio-based polymer, EPDM

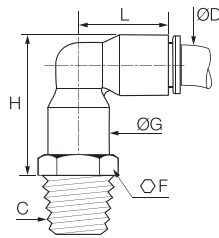

ØD	C		F	G	H	L	kg
1/4	NPT1/8	6509 56 11WP2	1/2	11	28	23.5	0.003
	NPT1/4	6509 56 14WP2	9/16	11	28	23.5	0.004
	NPT3/8	6509 56 18WP2	3/4	11	28.5	23.5	0.006
3/8	NPT1/4	6509 60 14WP2	3/4	16	38	34	0.010
	NPT3/8	6509 60 18WP2	3/4	16	38	34	0.011
1/2	NPT3/8	6509 62 18WP2	15/16	22	50.5	46.5	0.024
	NPT1/2	6509 62 22WP2	15/16	22	51.5	46.5	0.027

Thread without pre-coating, the body swivels for positioning purposes.

## 6509 Stud Elbow, Male BSPT Thread



Bio-based polymer, EPDM

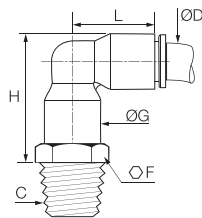

ØD	C		F	G	H	L	kg
1/4	R1/8	6509 56 10WP2	14	11	28	23.5	0.003
	R1/4	6509 56 13WP2	14	11	28	23.5	0.004
	R3/8	6509 56 17WP2	17	11	28	23.5	0.006
3/8	R1/4	6509 60 13WP2	19	16	38	34	0.010
	R3/8	6509 60 17WP2	19	16	38	34	0.011
1/2	R3/8	6509 62 17WP2	24	22	50.5	46.5	0.024
	R1/2	6509 62 21WP2	24	22	50.5	46.5	0.027

5/16" (8 mm) also available.

Thread without pre-coating, the body swivels for positioning purposes.

## 6508 Branch Tee, Male BSPT Thread



Bio-based polymer, EPDM

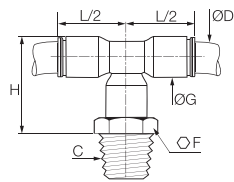

ØD	C		F	G	H	L/2	kg
6	R1/8	6508 06 10WP2	13	10.5	28	18	0.008
	R1/4	6508 06 13WP2	14	10.5	28	18	0.009
	R3/8	6508 06 17WP2	17	10.5	28	18	0.010
8	R1/8	6508 08 10WP2	19	13.5	34	23	0.012
	R1/4	6508 08 13WP2	19	13.5	34	23	0.013
	R3/8	6508 08 17WP2	19	13.5	34	23	0.013
10	R1/4	6508 10 13WP2	19	16	38	26.5	0.018
	R3/8	6508 10 17WP2	19	16	38	26.5	0.019
	R1/2	6508 10 21WP2	22	16	38	26.5	0.022
12	R3/8	6508 12 17WP2	22	19	44	31	0.024
	R1/2	6508 12 21WP2	22	19	44	31	0.026

Thread without pre-coating, the body swivels for positioning purposes.

## 6508 Branch Tee, Male NPTF Thread



Bio-based polymer, EPDM

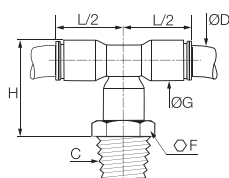

ØD	C		F	G	H	L/2	kg
1/4	NPT1/8	6508 56 11WP2	1/2	11	28	18	0.004
	NPT1/4	6508 56 14WP2	9/16	11	28	18	0.005
	NPT3/8	6508 56 18WP2	3/4	11	29	18	0.007
3/8	NPT1/4	6508 60 14WP2	3/4	16	38	26	0.013
	NPT3/8	6508 60 18WP2	3/4	16	38	26	0.013
1/2	NPT3/8	6508 62 18WP2	15/16	22	50	35.5	0.031
	NPT1/2	6508 62 22WP2	15/16	22	51	35.5	0.034

Thread without pre-coating, the body swivels for positioning purposes.

# Stud Fittings

## 6508 Branch Tee, Male BSPT Thread



Bio-based polymer, EPDM

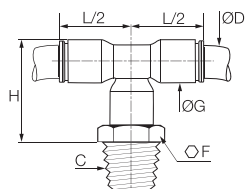

ØD	C		F	G	H	L/2	kg
R1/8	6508 56 10WP2		13	11	28	18	0.000
1/4	R1/4	6508 56 13WP2	14	11	28	18	0.000
	R3/8	6508 56 17WP2	17	11	28	18	0.000
3/8	R1/4	6508 60 13WP2	19	16	38	26	0.000
	R3/8	6508 60 17WP2	19	16	38	26	0.013
1/2	R3/8	6508 62 17WP2	24	22	50	35.5	0.000
	R1/2	6508 62 21WP2	24	22	50	35.5	0.000

5/16" (8 mm) also available.  
Thread without pre-coating, the body swivels for positioning purposes.

## 6503 Run Tee, Male BSPT Thread



Bio-based polymer, EPDM

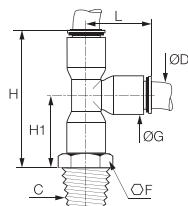

ØD	C		F	G	H	H1	L	kg
R1/8	6503 06 10WP2		13	10.5	40	22	18.5	0.008
6	R1/4	6503 06 13WP2	14	10.5	40	22	18.5	0.009
	R3/8	6503 06 17WP2	17	10.5	40	22	18.5	0.010
8	R1/8	6503 08 10WP2	19	13.5	50	27	23	0.012
	R1/4	6503 08 13WP2	19	13.5	50	27	23	0.013
10	R3/8	6503 08 17WP2	19	13.5	50	27	23	0.013
	R1/4	6503 10 13WP2	19	16	56.5	30	26.5	0.018
12	R3/8	6503 10 17WP2	19	16	56.5	30	26.5	0.019
	R1/2	6503 10 21WP2	22	16	56.5	30	26.5	0.022
12	R3/8	6503 12 17WP2	22	19	65.5	34.5	31	0.024
	R1/2	6503 12 21WP2	22	19	65.5	34.5	31	0.026

Thread without pre-coating, the body swivels for positioning purposes.

## 6503 Run Tee, Male BSPT Thread



Bio-based polymer, EPDM

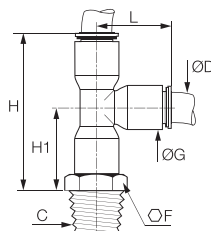

ØD	C		F	G	H	H1	L	kg
NPT1/8	6503 56 11WP2		1/2	11	40.5	22.5	18	0.004
1/4	NPT1/4	6503 56 14WP2	9/16	11	40.5	22.5	18	0.005
	NPT3/8	6503 56 18WP2	3/4	11	41.5	23	18	0.007
3/8	NPT1/4	6503 60 14WP2	3/4	16	56	30	26	0.013
	NPT3/8	6503 60 18WP2	3/4	16	56	30	26	0.013
1/2	NPT3/8	6503 62 18WP2	15/16	22	75	39.5	35.5	0.031
	NPT1/2	6503 62 22WP2	15/16	22	76	40.5	35.5	0.035

Thread without pre-coating, the body swivels for positioning purposes.

## 6503 Run Tee, Male BSPT Thread



Bio-based polymer, EPDM

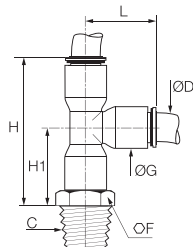

ØD	C		F	G	H	H1	L	kg
R1/8	6503 56 10WP2		14	11	41.5	22.5	18	0.004
1/4	R1/4	6503 56 13WP2	14	11	41.5	22.5	18	0.005
	R3/8	6503 56 17WP2	17	11	41.5	23	18	0.007
3/8	R1/4	6503 60 13WP2	19	16	56	30	26	0.013
	R3/8	6503 60 17WP2	19	16	56	30	26	0.013
1/2	R3/8	6503 62 17WP2	24	22	75	39.5	35.5	0.032
	R1/2	6503 62 21WP2	24	22	75	39.5	35.5	0.035

Thread without pre-coating, the body swivels for positioning purposes.

## 6355 Unequal Connector, Female BSPP Thread



Bio-based polymer

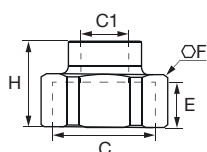

C	C1		E	F	H	kg
G3/4	G1/4	6355 13 27WP2	10	32	23.5	0.050

# Tube-to-Tube Fittings

## 6306 Equal and Unequal Tube-to-Tube Connector



Bio-based polymer, EPDM

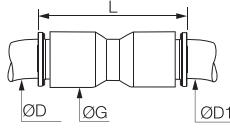

ØD	ØD1			G	L	kg
4	4	<a href="#">6306 04 00WP2</a>		8.5	26.5	0.002
	6	<a href="#">6306 04 06WP2</a>		10.5	29	0.002
	8	<a href="#">6306 04 08WP2</a>		13.5	37	0.005
6	6	<a href="#">6306 06 00WP2</a>	<a href="#">6306 06 00WP3</a>	10.5	30	0.004
	8	<a href="#">6306 06 08WP2</a>		13.5	37	0.005
	10	<a href="#">6306 06 10WP2</a>		16	42	0.007
8	8	<a href="#">6306 08 00WP2</a>	<a href="#">6306 08 00WP3</a>	13.5	37	0.004
	10	<a href="#">6306 08 10WP2</a>		16	42	0.007
	12	<a href="#">6306 08 12WP2</a>		19	50	0.012
10	10	<a href="#">6306 10 00WP2</a>	<a href="#">6306 10 00WP3</a>	16	42	0.009
	12	<a href="#">6306 10 12WP2</a>		19	50	0.013
12	12	<a href="#">6306 12 00WP2</a>	<a href="#">6306 12 00WP3</a>	19	50.5	0.009

WP3 = high volumes (number of parts per bag: 40, 50 or 100, depending on the diameters)

## 6306 Equal and Unequal Union Connector



Inch

Bio-based polymer, EPDM

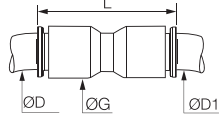

ØD	ØD1			G	L	kg
5/16	3/8	<a href="#">6306 08 60WP2</a>		16	42	0.008
	1/2	<a href="#">6306 08 62WP2</a>		22	55	0.018
1/4	1/4	<a href="#">6306 56 00WP2</a>	<a href="#">6306 56 00WP3</a>	11	30	0.004
	5/16	<a href="#">6306 56 08WP2</a>	<a href="#">6306 56 08WP3</a>	13.5	37	0.007
	3/8	<a href="#">6306 56 60WP2</a>		16	41	0.007
3/8	3/8	<a href="#">6306 60 00WP2</a>	<a href="#">6306 60 00WP3</a>	16	42	0.006
	1/2	<a href="#">6306 60 62WP2</a>		22	56	0.020
1/2	1/2	<a href="#">6306 62 00WP2</a>		22	57	0.016

WP3 = high volumes (number of parts per bag: 40, 50 or 100, depending on the diameters)

## 6302 Equal and Unequal Elbow



Bio-based polymer, EPDM

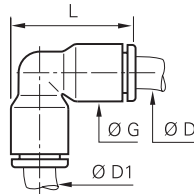

ØD	ØD1			G	L	kg
4	4	<a href="#">6302 04 00WP2</a>		8.5	19	0.002
	6	<a href="#">6302 04 06WP2</a>		10.5	24	0.004
6	6	<a href="#">6302 06 00WP2</a>	<a href="#">6302 06 00WP3</a>	10.5	24	0.004
	8	<a href="#">6302 06 08WP2</a>		13.5	29.5	0.006
8	8	<a href="#">6302 08 00WP2</a>	<a href="#">6302 08 00WP3</a>	13.5	29	0.004
	10	<a href="#">6302 08 10WP2</a>		16	34.5	0.008
10	10	<a href="#">6302 10 00WP2</a>	<a href="#">6302 10 00WP3</a>	16	34.5	0.005
	12	<a href="#">6302 10 12WP2</a>		19	40.5	0.013
12	12	<a href="#">6302 12 00WP2</a>	<a href="#">6302 12 00WP3</a>	19	40.5	0.010

WP3 = high volumes (number of parts per bag: 40, 50 or 100, depending on the diameters)

## 6302 Equal and Unequal Union Elbow



Inch

Bio-based polymer, EPDM

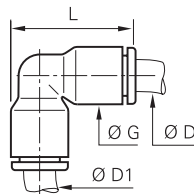

ØD	ØD1			G	L	kg
5/16	3/8	<a href="#">6302 08 60WP2</a>		16	34	0.009
	1/4	<a href="#">6302 56 00WP2</a>	<a href="#">6302 56 00WP3</a>	11	24	0.005
1/4	5/16	<a href="#">6302 56 08WP2</a>	<a href="#">6302 56 08WP3</a>	13.5	29.5	0.006
	3/8	<a href="#">6302 56 60WP2</a>		16	34	0.008
3/8	3/8	<a href="#">6302 60 00WP2</a>	<a href="#">6302 60 00WP3</a>	16	34	0.006
	1/2	<a href="#">6302 60 62WP2</a>		22	46.5	0.011
1/2	1/2	<a href="#">6302 62 00WP2</a>		22	46.5	0.017

WP3 = high volumes (number of parts per bag: 40, 50 or 100, depending on the diameters)



# Tube-to-Tube Fittings

## 6304 Equal Tee



Bio-based polymer, EPDM

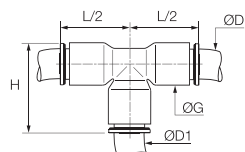

ØD	ØD1			G	H	L/2	kg	
4	4	<a href="#">6304 04 00WP2</a>			8.5	20	15.5	0.004
6	6	<a href="#">6304 06 00WP2</a>	<a href="#">6304 06 00WP3</a>		10.5	23	18	0.006
8	8	<a href="#">6304 08 00WP2</a>	<a href="#">6304 08 00WP3</a>		13.5	29	22.5	0.006
10	10	<a href="#">6304 10 00WP2</a>	<a href="#">6304 10 00WP3</a>		16	34.5	26.5	0.009
12	12	<a href="#">6304 12 00WP2</a>	<a href="#">6304 12 00WP3</a>		19	40	31	0.014

WP3 = high volumes (number of parts per bag: 40, 50 or 100, depending on the diameters)

## 6304 Equal and Unequal Tee



Bio-based polymer, EPDM

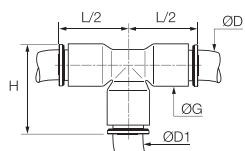

ØD	ØD1			G	H	L/2	kg	
1/4	1/4	<a href="#">6304 56 00WP2</a>	<a href="#">6304 56 00WP3</a>		11	24	18	0.002
3/8	3/8	<a href="#">6304 60 00WP2</a>	<a href="#">6304 60 00WP3</a>		16	34	26	0.009
	1/4	<a href="#">6304 60 56WP2</a>			16	34	26	0.011
1/2	1/2	<a href="#">6304 62 00WP2</a>			22	47	36	0.027
	3/8	<a href="#">6304 62 60WP2</a>			22	47	36	0.009

WP3 = high volumes (number of parts per bag: 40, 50 or 100, depending on the diameters)  
5/32" (4 mm) and 5/16" (8 mm) also available

## 6340 Equal Single Y Piece



Bio-based polymer, EPDM

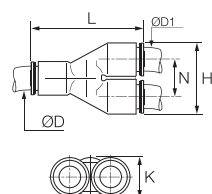

ØD	ØD1			H	K	L	N	kg
4	4	<a href="#">6340 04 00WP2</a>		17.5	8.5	30	9	0.004
6	6	<a href="#">6340 06 00WP2</a>	<a href="#">6340 06 00WP3</a>	21.5	10.5	36.5	11	0.008
8	8	<a href="#">6340 08 00WP2</a>		28	13.5	44.5	14.5	0.007
10	10	<a href="#">6340 10 00WP2</a>		33	16	53	17	0.010
12	12	<a href="#">6340 12 00WP2</a>		39	19	60.5	20	0.025

WP3 = high volumes (number of parts per bag: 40, 50 or 100, depending on the diameters)

## 6340 Equal Single Y Piece



Bio-based polymer, EPDM

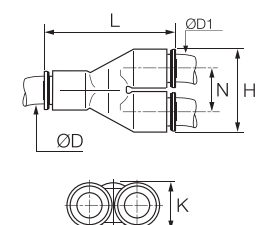

ØD	ØD1			H	K	L	N	kg
1/4	1/4	<a href="#">6340 56 00WP2</a>	<a href="#">6340 56 00WP3</a>	22	11	36	11.5	0.010
3/8	3/8	<a href="#">6340 60 00WP2</a>		33	16	53	17	0.011
1/2	1/2	<a href="#">6340 62 00WP2</a>		45	22	67	23	0.028

WP3 = high volumes (number of parts per bag: 40, 50 or 100, depending on the diameters).  
5/32" (4 mm) and 5/16" (8 mm) also available

# Tube-to-Tube and Bulkhead Connectors

## 6307 Equal Cross



Bio-based polymer, EPDM

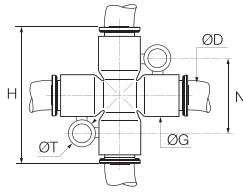

ØD		G	H	N	ØT	kg
6	<a href="#">6307 06 00WP2</a>	11	36	20	4.2	0.005
8	<a href="#">6307 08 00WP2</a>	13.5	45	22.5	4.2	0.020

## 6307 Equal Cross



Inch

Bio-based polymer, EPDM

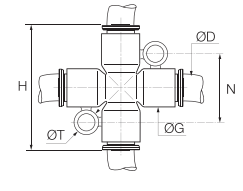

ØD		G	H	L	ØT	kg
1/4	<a href="#">6307 56 00WP2</a>	11	36	20	4.2	0.010

5/16" (8 mm) also available

## 6316 Equal Bulkhead Union



Bio-based polymer, EPDM

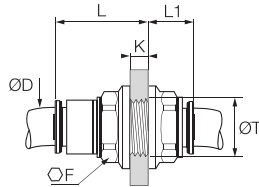

ØD			F	K max	L	L1	ØT min	kg
4	<a href="#">6316 04 00WP2</a>		13	5.5	15.5	10.5	10.5	0.018
6	<a href="#">6316 06 00WP2</a>	<a href="#">6316 06 00WP3</a>	15	8.5	20	10	12.5	0.004
8	<a href="#">6316 08 00WP2</a>	<a href="#">6316 08 00WP3</a>	18	14.5	27	10.5	15.5	0.007
10	<a href="#">6316 10 00WP2</a>	<a href="#">6316 10 00WP3</a>	22	14.5	30	13	18.5	0.012
12	<a href="#">6316 12 00WP2</a>	<a href="#">6316 12 00WP3</a>	26	18.5	35	15.5	22.5	0.020

WP3 = high volumes (number of parts per bag: 40, 50 or 100, depending on the diameters)

## 6316 Equal Bulkhead Union



Inch

Bio-based polymer, EPDM

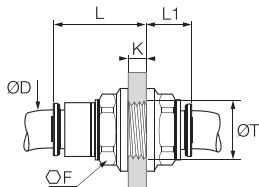

ØD			F	K max	L	L1	ØT min	kg
1/4	<a href="#">6316 56 00WP2</a>	<a href="#">6316 56 00WP3</a>	15	8.5	20	10	12.5	0.004
3/8	<a href="#">6316 60 00WP2</a>		22	14.5	29.5	12.5	18.5	0.012
1/2	<a href="#">6316 62 00WP2</a>		29	20.5	40.5	17	25.5	0.030

WP3 = high volumes (number of parts per bag: 40, 50 or 100, depending on the diameters)  
5/32" (4 mm) and 5/16" (8 mm) also available

# Plug-In Fittings and Accessories

## 6382 Equal and Unequal Plug-In Elbow



Bio-based polymer, EPDM

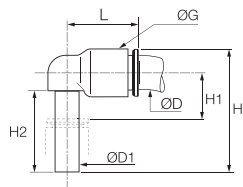

ØD	ØD1			G	H	H1	H2	L	kg
4	4	<a href="#">6382 04 00WP2</a>		8.5	23	6	15.5	15	0.003
	6	<a href="#">6382 04 06WP2</a>		10.5	26.5	7	17	16.5	0.002
6	6	<a href="#">6382 06 00WP2</a>	<a href="#">6382 06 00WP3</a>	10.5	26.5	7	17	17	0.003
	4	<a href="#">6382 06 04WP2</a>		10.5	25	7	15.5	17	0.001
	8	<a href="#">6382 06 08WP2</a>		13.5	33.5	8	21.5	22.5	0.004
	8	<a href="#">6382 06 08WP2</a>	<a href="#">6382 06 08WP3</a>	13.5	33.5	8	21.5	22.5	0.004
8	10	<a href="#">6382 08 10WP2</a>		16	39	9.5	24.5	26	0.007
	10	<a href="#">6382 10 00WP2</a>	<a href="#">6382 10 00WP3</a>	16	39	9.5	24.5	26.5	0.004
10	12	<a href="#">6382 10 12WP2</a>		19	44.5	10	27	30	0.011
	12	<a href="#">6382 12 00WP2</a>	<a href="#">6382 12 00WP3</a>	19	44.5	10	27	31	0.012

WP3 = high volumes (number of parts per bag: 40, 50 or 100, depending on the diameters).

## 6382 Equal and Unequal Plug-In Elbow



Inch

Bio-based polymer, EPDM

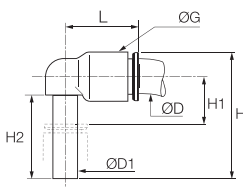

ØD	ØD1			G	H	H1	H2	L	kg
5/16	3/8	<a href="#">6382 08 60WP2</a>		16	39	10	24.5	26	0.009
1/4	1/4	<a href="#">6382 56 00WP2</a>	<a href="#">6382 56 00WP3</a>	11	30.5	11	18	18	0.000
	3/8	<a href="#">6382 56 06WP2</a>		16	39	9	24.5	25.5	0.006
3/8	3/8	<a href="#">6382 60 00WP2</a>	<a href="#">6382 60 00WP3</a>	16	39	9	24.5	26.5	0.005
1/2	1/2	<a href="#">6382 62 00WP2</a>		22	49	13	28.5	36	0.000

WP3 = high volumes (number of parts per bag: 40, 50 or 100, depending on the diameters)  
Equal plug-in elbow: 5/32" (4 mm) and 5/16" (8 mm) also available

## 6380 Plug-In 45° Equal Elbow



Bio-based polymer, EPDM

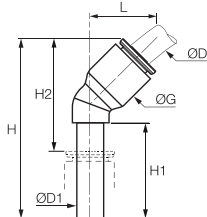

ØD	ØD1			G	H	H1	H2	L	kg
4	4	<a href="#">6380 04 00WP2</a>		8.5	33.5	19	21	13	0.001
6	6	<a href="#">6380 06 00WP2</a>		11	39	21	25	14.5	0.002
8	8	<a href="#">6380 08 00WP2</a>		13.5	44	21.5	25.5	19.5	0.006
10	10	<a href="#">6380 10 00WP2</a>		16	53	27	32.5	23	0.004
12	12	<a href="#">6380 12 00WP2</a>		19	58	27	34	26	0.012

## 6383 Plug-In Equal Run Tee



Bio-based polymer, EPDM

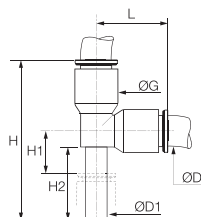

ØD	ØD1			G	H	H1	H2	L	kg
4	4	<a href="#">6383 04 00WP2</a>		8.5	33	6	15.5	15	0.002
6	6	<a href="#">6383 06 00WP2</a>		10.5	38.5	7	17	18	0.002
8	8	<a href="#">6383 08 00WP2</a>	<a href="#">6383 08 00WP3</a>	13.5	49	8	21.5	23	0.005
10	10	<a href="#">6383 10 00WP2</a>		16	57	10.5	25.5	26.5	0.012
12	12	<a href="#">6383 12 00WP2</a>		19	65	36.5	27	31	0.016

WP3 = high volumes (number of parts per bag: 40, 50 or 100, depending on the diameters)

## 6388 Plug-In Equal Branch Tee



Bio-based polymer, EPDM

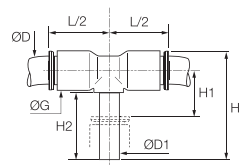

ØD	ØD1			G	H	H1	H2	L/2	kg
4	4	<a href="#">6388 04 00WP2</a>		8.5	25	6	15.5	15	0.005
6	6	<a href="#">6388 06 00WP2</a>		10.5	28.5	7	17	16	0.006
8	8	<a href="#">6388 08 00WP2</a>		13.5	33.5	8	21.5	23	0.005
10	10	<a href="#">6388 10 00WP2</a>		16	41	9.5	24.5	26.5	0.007
12	12	<a href="#">6388 12 00WP2</a>		19	46.5	10	27	31	0.016

# Plug-In Fittings and Accessories

## 6388 Plug-In Branch Tee



Bio-based polymer, EPDM

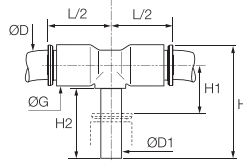

ØD	ØD1			G	H	H1	H2	L/2	kg
1/4	1/4			11	30.5	11	20	18	0.002
3/8	3/8			16	42	12	25	25	0.008
1/2	1/2			22	51	13	29	32	0.020

5/32" (4 mm) and 5/16" (8 mm) also available

## 6366 Plug-In Reducer



Bio-based polymer, EPDM

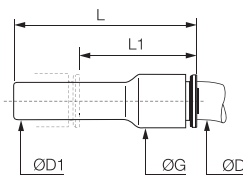

ØD	ØD1			G	L	L1	kg
4	6			8.5	38	23.5	0.004
	8			8.5	38	19	0.004
6	8			10.5	38	20	0.004
	10			10.5	39	17.5	0.002
8	10			13.5	48.5	28.5	0.009
	12			13.5	48.5	24.5	0.004
10	12			16	52	33.5	0.005
	14			16	53	33.5	0.005
12	14			19	55.5	33.5	0.023

WP3 = high volumes (number of parts per bag: 40, 50 or 100, depending on the diameters)

## 6366 Plug-In Reducer



Bio-based polymer, EPDM

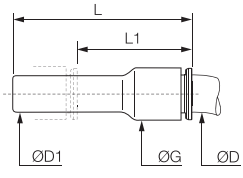

ØD	ØD1			G	L	L1	kg
1/4	5/16			11	41	22.5	0.015
	3/8			11	41	20.5	0.002
5/16	3/8			13.5	48.5	29	0.003
	1/2			16	48.5	22	0.007
3/8	1/2			16	51	30	0.011

5/32" (4 mm) and 5/16" (8 mm) also available

## 6368 Plug-In Increaser



Bio-based polymer, EPDM

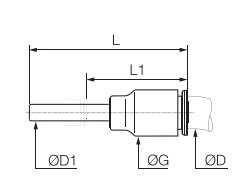

ØD	ØD1			G	L	L1	kg
3/8	5/16			16	44	25.5	0.004

## 6326 Blanking Plug



Bio-based polymer

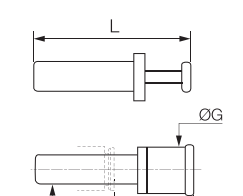

ØD				G	L	L1	kg
4				6	30	15.5	0.001
6				8	33	16.5	0.001
8				10	35	17.5	0.002
10				12	42	21	0.003
12				14	45	22	0.004

WP3 = high volumes (number of parts per bag: 40, 50 or 100, depending on the diameters)

# Plug-In Fittings and Accessories

## 6326 Blanking Plug



Bio-based polymer

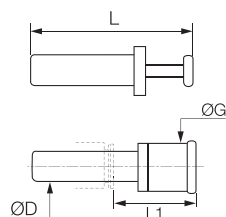

ØD			G	L	L1	kg
1/4	<a href="#">6326 56 00WP2</a>	<a href="#">6326 56 00WP3</a>	8	36.5	22	0.001
3/8	<a href="#">6326 60 00WP2</a>		11.6	42.5	22	0.002
1/2	<a href="#">6326 62 00WP2</a>		14.7	48.5	21.5	0.004

WP3 = high volumes (number of parts per bag: 40, 50 or 100, depending on the diameters)  
5/32" (4 mm) and 5/16" (8 mm) also available

## 6322 Plug-In Barb Connector



Bio-based polymer

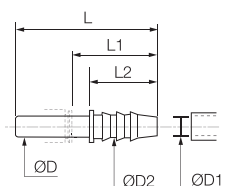

ØD	ØD1	ØD2		L	L1	L2	kg
6	4	7	<a href="#">6322 06 04WP2</a>	39	25	17	0.004
8	6	8.5	<a href="#">6322 08 06WP2</a>	43	25	17	0.005
10	7	8	<a href="#">6322 10 07WP2</a>	50	29.5	22	0.006
12	12.5	15.5	<a href="#">6322 12 62WP2</a>	56	32	27.5	0.004

## 6322 Plug-In Barb Connector



Bio-based polymer

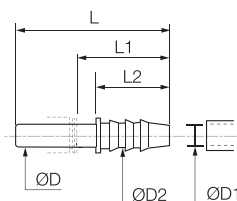

ØD	ØD1	ØD2		L	L1	L2	kg
1/4	0.28	0.32	<a href="#">6322 56 56WP2</a>	39	24.5	17	0.001
	0.33	0.38	<a href="#">6322 60 08WP2</a>	50	29.5	22	0.001
3/8	0.28	0.32	<a href="#">6322 60 56WP2</a>	45	24.5	17	0.008
	0.40	0.45	<a href="#">6322 60 60WP2</a>	50	29	22	0.002
1/2	0.40	0.45	<a href="#">6322 62 60WP2</a>	58	37.5	30	0.005

## 6351 End Cap



Bio-based polymer, EPDM

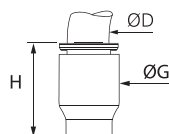

ØD		G	H	kg
4	<a href="#">6351 04 00WP2</a>	8.5	15	0.001
6	<a href="#">6351 06 00WP2</a>	10.5	17	0.002
8	<a href="#">6351 08 00WP2</a>	13.5	21.5	0.003
10	<a href="#">6351 10 00WP2</a>	16	22	0.003
12	<a href="#">6351 12 00WP2</a>	19	27.5	0.006

## 6351 End Cap



Bio-based polymer, EPDM

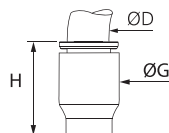

ØD		G	H	kg
1/4	<a href="#">6351 56 00WP2</a>	11	16	0.001
3/8	<a href="#">6351 60 00WP2</a>	16	22.5	0.003

5/32" (4 mm) and 5/16" (8 mm) also available

# Accessories

## 3130 Tamper-Proof Safety Clip

Technical polymer

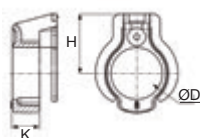

ØD							H	K	kg
4	3130 04 01	3130 04 02	3130 04 03	3130 04 04	3130 04 05	3130 04 10	6.5	3	0.001
6	3130 06 01	3130 06 02	3130 06 03	3130 06 04	3130 06 05	3130 06 10	8	3	0.001
8	3130 08 01	3130 08 02	3130 08 03	3130 08 04	3130 08 05	3130 08 10	9.5	4.3	0.001
10	3130 10 01	3130 10 02	3130 10 03	3130 10 04	3130 10 05	3130 10 10	10.8	4.2	0.001
12	3130 12 01	3130 12 02	3130 12 03	3130 12 04	3130 12 05	3130 12 10	12.5	5.1	0.004

## 3130 Tamper-Proof Safety Clip

Inch

Technical polymer

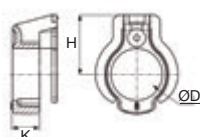

ØD							H	K	kg
1/4	3130 56 01	3130 56 02	3130 56 03	3130 56 04	3130 56 05	3130 56 10	8	3	0.001
3/8	3130 60 01	3130 60 02	3130 60 03	3130 60 04	3130 60 05	3130 60 10	11	4	0.001
1/2	3130 62 01	3130 62 02	3130 62 03	3130 62 04	3130 62 05	3130 62 10	14	6	0.004

5/32" (4 mm) and 5/16" (8 mm) also available

## 3110 Coloured Release Button Covers

Technical polymer



ØD						kg
4	3110 04 00	3110 04 02	3110 04 03	3110 04 04	3110 04 05	0.006
6	3110 06 00	3110 06 02	3110 06 03	3110 06 04	3110 06 05	0.001
8	3110 08 00	3110 08 02	3110 08 03	3110 08 04	3110 08 05	0.001
10	3110 10 00	3110 10 02	3110 10 03	3110 10 04	3110 10 05	0.001
12	3110 12 00	3110 12 02	3110 12 03	3110 12 04	3110 12 05	0.001

## 3110 Coloured Release Button Covers

Inch

Technical polymer



ØD						kg
1/4	3110 56 00	3110 56 02	3110 56 03	3110 56 04	3110 56 05	0.002
3/8	3110 60 00	3110 60 02	3110 60 03	3110 60 04	3110 60 05	0.001
1/2	3110 62 00	3110 62 02	3110 62 03	3110 62 04	3110 62 05	0.001

5/32" (4 mm) and 5/16" (8 mm) also available

## 0605 Fluoropolymer Tape

FKM



0605 12 12

kg

0.012

Can be used for temperatures from - 250°C to +260°C.

Chemically inert and resistant to gases, acids, solvents, hydrocarbons, oils, alkalines, steam etc.

Non-toxic, waterproof, self-lubricating.

In accordance with CFR21.

Can be used on all materials.

Used to facilitate the preparation of leak-free threaded joints.

Supplied on a reel, length = 12 m, width = 12.7 mm, thickness 0.08 mm.



LIQUIfit®

Push-In Fittings



# LIQUIfit+ Push-In Fittings

For the transfer of sensitive fluids, the LIQUIfit+ range **reduces the growth of bacteria** in your circuits **for 100% cleanliness after cleaning**, and can be **directly** connected to stainless steel tubing, without grooving.

## Product Advantages

### Zero Retention for 100% Cleanliness

- Up to 10 times less microbial growth within the fitting
- Elimination of 99.9% of bacteria during cleaning operations
- No degradation of the beverage taste
- Preservation of the integrity of sensitive or industrial fluids
- Extension of the fitting's life due to the absence of bacteria after cleaning

### Quality & Reliability

- 100% leak-tested in production
- Date coding to guarantee quality and traceability
- Quality approved for contact with food
- Excellent chemical resistance (chlorine, cleaning agents, UV...)
- Excellent long-term mechanical resistance
- Safety clip to avoid any untimely disconnection

### Innovative Technology

- Patented push-in connection, unique on stainless steel tubing for diameters 5/16" and 3/8" (without preparation) and on polymer tubing
- Extremely compact
- 100% bio-based material
- Patented sealing technology (FR29461418)
- No tube movement after connection



Applications

- Food Process
- Medical
- Beverage Dispensers
- Pharmaceutical
- Chemical
- Brewing

## Technical Characteristics

<b>Compatible Fluids</b>	Beer, water, beverages, industrial fluids
<b>Working Pressure</b>	Vacuum to 16 bar
<b>Working Temperature</b>	-10°C to +95°C (see LIQUIfit® chart p. 1-47)

Reliable performance is dependent upon the type of fluid conveyed, component materials and tubing being used. The use is guaranteed with a vacuum of 755 mm Hg (99% vacuum).

### Component Materials

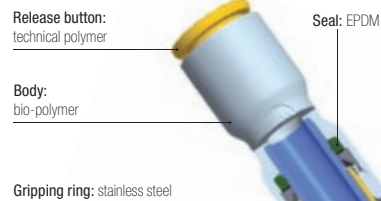

### Silicone-free

### Cleaning Efficiency

Comparison of the contamination by micro-organisms before and after cleaning operations (cfu/surface)\*

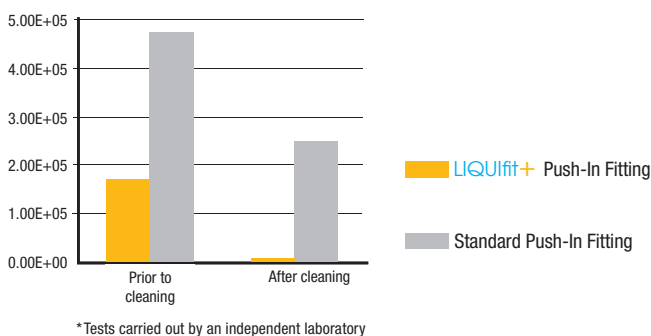

### Regulations

DI: 2002/95/EC (RoHS), 2011/65/EC  
 RG: 1935/2004/EC  
 RG: 1907/2006 (REACH)

FDA: 21 CFR  
 NSF51  
 NSF/ANSI 61 - C HOT  
 WRAS

### Performance

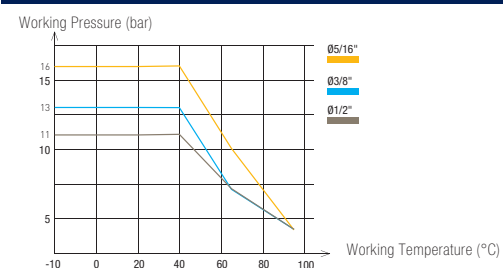

# LIQUIfit+ Push-In Fittings

## 6333 Stud Fitting, Female BSPP Thread



Bio-based polymer, EPDM

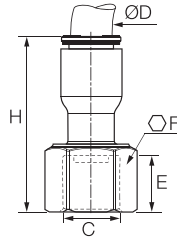

ØD	C		E	F	H	kg
3/8	G1/2	<a href="#">6333 60 21WP3</a>	14	11	30	0.010
	G5/8	<a href="#">6333 60 23WP3</a>	14	13	36	0.016

WP3 suffix = high volume (number of parts per bag: 40, 50 or 100 depending on the diameters)

## 6336 Equal and Unequal Tube-To-Tube Connector



Bio-based polymer, EPDM

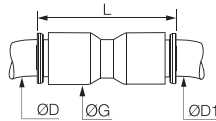

ØD	ØD1		G	L	kg
5/16	5/16	<a href="#">6336 08 00WP3</a>	13.5	37	0.004
	3/8	<a href="#">6336 08 60WP3</a>	16	42	0.008
	1/2	<a href="#">6336 08 62WP3</a>	22	55	0.016
3/8	3/8	<a href="#">6336 60 00WP3</a>	16	42	0.006
	1/2	<a href="#">6336 60 62WP3</a>	22	56	0.020
1/2	1/2	<a href="#">6336 62 00WP3</a>	22	57	0.016

WP3 = high volume (number of parts per bag: 40, 50 or 100 depending on the diameters)

## 6332 Equal and Unequal Elbow



Bio-based polymer, EPDM

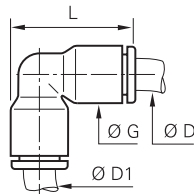

ØD	ØD1		G	L	kg
5/16	5/16	<a href="#">6332 08 00WP3</a>	13.5	29	0.004
	3/8	<a href="#">6332 08 60WP3</a>	16	34	0.009
3/8	3/8	<a href="#">6332 60 00WP3</a>	16	34	0.006
	1/2	<a href="#">6332 60 62WP3</a>	22	46.5	0.011
1/2	1/2	<a href="#">6332 62 00WP3</a>	22	46.5	0.017

WP3 = high volume (number of parts per bag: 40, 50 or 100 depending on the diameters)

## 6331 Equal Plug-In Elbow



Bio-based polymer, EPDM

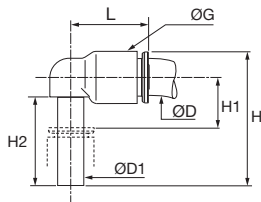

ØD	ØD1		G	H	H1	H2	L	kg
5/16	5/16	<a href="#">6331 08 00WP3</a>	13.5	33.5	8	21.5	22.5	0.004
3/8	3/8	<a href="#">6331 60 00WP3</a>	16	39	9	24.5	26.5	0.005

WP3 = high volume (number of parts per bag: 40, 50 or 100 depending on the diameters)

### Use with Stainless Steel Tubing

- Valid exclusively for diameters 5/16" and 3/8".
- These fittings are approved for use with 304 and 316L stainless steel tubing, 160 Hv, with tolerances on the external diameter +0.05/-0.10 mm.
- Carefully deburr the stainless steel tube end.
- For easy disconnection, press firmly on the release button.
- After 5 connections/disconnections, we recommend that you change the fitting.



# LIQUIfit® Push-In Fittings with Metal Adaptors

The LIQUIfit® range now benefits from a range extension of **metal adaptors** designed for **liquid transfer applications**. These fittings ensure **reliable** and **compact** connections combined with **excellent robustness**.

## Product Advantages

### Innovative Technology & Concept

- Ergonomic and aesthetic design
- Compact product for water applications
- Easy-to-clean external surfaces
- Full flow
- Use with a pre-prepared metallic tubing
- Gripping system preventing any pumping effect

### Optimal Performance

- Patented sealing technology
- 100% leak-tested in production
- Date coding to guarantee quality and traceability
- Wide range of shapes and numerous configurations
- Excellent robustness for a long lifespan

### High Performance Material

- Bio-sourced polymer body meeting the most severe food process regulations
- Compatibility with beverages (stainless steel version)
- Unsurpassed chemical and mechanical resistance, even at high temperatures
- Free of bisphenol A and phthalates, conforming with regulations



Industrial Fluids  
Beverage Process  
Inert Gases  
Cooling Systems  
Food Process

Applications

## Technical Characteristics

<b>Compatible Fluids</b>	Water, beverages, industrial fluids: stainless steel threads Industrial fluids: FDA chemical nickel-plated brass threads					
<b>Working Pressure</b>	Vacuum to 16 bar					
<b>Working Temperature</b>	-10°C to +95°C (see LIQUIfit® chart p. 1-47)					
<b>Tightening Torques (BSPP)</b>	Thread	M5 X0.8	G1/8	G1/4	G3/8	G1/2
	daN.m	0.16	0.8	1.2	3	3.5

Reliable performance is dependent upon the type of fluid conveyed, component materials and tubing being used.  
Use is guaranteed with a vacuum of 755 mm Hg (99% vacuum).

### Component Materials

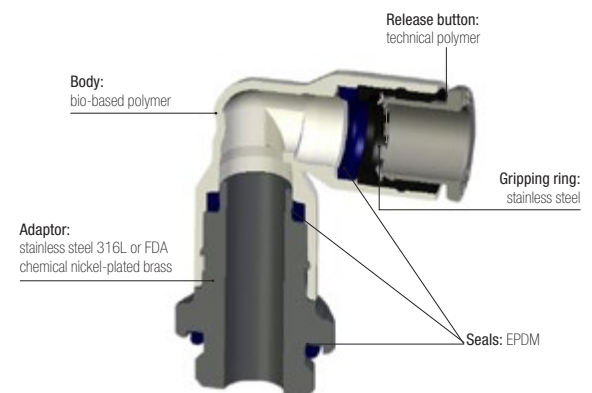

Silicone-free

### Performance

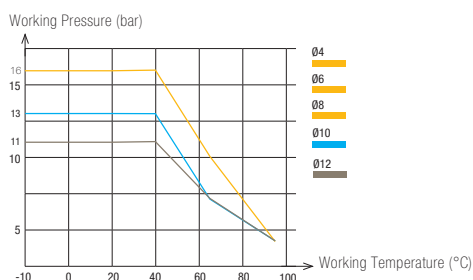

### Regulations

- DI: 2002/95/EC (RoHS), 2011/65/EC
- RG: 1935/2004/EC
- RG: 1907/2006 (REACH)
- FDA: 21 CFR
- NSF 51 (pending)
- NSF/ANSI 61 (pending, for stainless steel version only)

# Stud Fittings with Stainless Steel Adaptor

## 6911 Stud Fitting, Male BSPP and Metric Thread



Stainless steel 316L, EPDM

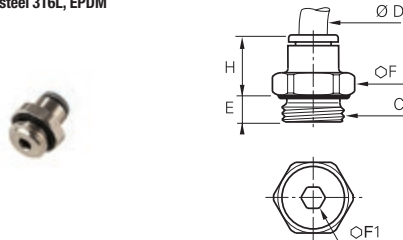

ØD	C		E	F	F1	H	kg
4	M5x0.8	<a href="#">6911 04 19</a>	3	10	2.5	14	0.006
	G1/8	<a href="#">6911 04 10</a>	4.5	13	3	11.5	0.007
	G1/4	<a href="#">6911 04 13</a>	5.5	16	3	10.5	0.011
6	M5x0.8	<a href="#">6911 06 19</a>	3	10	2.5	16	0.005
	G1/8	<a href="#">6911 06 10</a>	4.5	13	4	13	0.007
	G1/4	<a href="#">6911 06 13</a>	5.5	16	4	12.5	0.011
8	G1/8	<a href="#">6911 08 10</a>	4.5	13	5	20.5	0.011
	G1/4	<a href="#">6911 08 13</a>	5.5	16	6	19.5	0.016
	G3/8	<a href="#">6911 08 17</a>	5.5	21	6	18	0.022
10	G1/4	<a href="#">6911 10 13</a>	5.5	16	7	23	0.018
	G3/8	<a href="#">6911 10 17</a>	5.5	21	8	19.5	0.021
	G1/2	<a href="#">6911 10 21</a>	7	24	8	18	0.033
12	G3/8	<a href="#">6911 12 17</a>	5.5	21	9	27	0.029
	G1/2	<a href="#">6911 12 21</a>	7	24	10	22.5	0.035

## 6975 Stud Fitting, Male BSPT Thread



Stainless steel 316L, EPDM

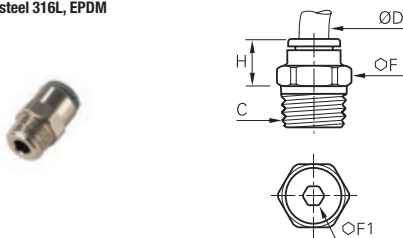

ØD	C		F	F1	H	kg
4	R1/8	<a href="#">6975 04 10</a>	10	3	9.5	0.005
	R1/4	<a href="#">6975 04 13</a>	14	3	6.5	0.012
6	R1/8	<a href="#">6975 06 10</a>	10	4	11.5	0.005
	R1/4	<a href="#">6975 06 13</a>	14	4	8.5	0.011
8	R1/8	<a href="#">6975 08 10</a>	13	5	20	0.011
	R1/4	<a href="#">6975 08 13</a>	14	6	17	0.014
10	R3/8	<a href="#">6975 08 17</a>	17	6	13	0.021
	R1/4	<a href="#">6975 10 13</a>	16	7	20	0.017
	R3/8	<a href="#">6975 10 17</a>	17	8	16.5	0.019
12	R1/2	<a href="#">6975 10 21</a>	21	8	14	0.037
	R3/8	<a href="#">6975 12 17</a>	19	9	24	0.028
	R1/2	<a href="#">6975 12 21</a>	21	10	19.5	0.036

## 6959 Stud Elbow, Male BSPP and Metric Thread



Bio-based polymer, stainless steel 316L, EPDM

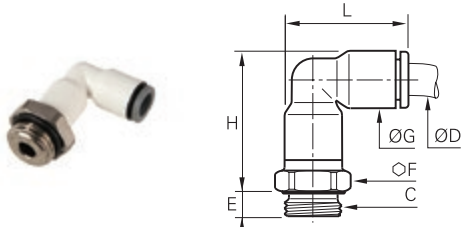

ØD	C		E	F	G	H	L	kg
4	M5x0.8	<a href="#">6959 04 19</a>	3.5	10	8.5	23	19	0.009
	G1/8	<a href="#">6959 04 10</a>	4.5	13	8.5	22.5	19	0.009
	G1/4	<a href="#">6959 04 13</a>	5.5	16	8.5	22.5	19	0.014
6	M5x0.8	<a href="#">6959 06 19</a>	3.5	10	10.5	26.5	22.5	0.008
	G1/8	<a href="#">6959 06 10</a>	4.5	13	10.5	26.5	22.5	0.011
	G1/4	<a href="#">6959 06 13</a>	5.5	16	10.5	26.5	22.5	0.016
8	G1/8	<a href="#">6959 08 10</a>	4.5	13	13.5	35	29.5	0.018
	G1/4	<a href="#">6959 08 13</a>	5.5	16	13.5	33	29.5	0.020
	G3/8	<a href="#">6959 08 17</a>	5.5	21	13.5	33	29.5	0.028
10	G1/4	<a href="#">6959 10 13</a>	5.5	16	16	40.5	34	0.029
	G3/8	<a href="#">6959 10 17</a>	5.5	21	16	39	34	0.037
	G1/2	<a href="#">6959 10 21</a>	7	24	16	39	34	0.042
12	G3/8	<a href="#">6959 12 17</a>	5.5	21	19	42	40	0.040
	G1/2	<a href="#">6959 12 21</a>	7	24	19	42	40	0.049

The body swivels for positioning purposes.

# Stud Fittings with Stainless Steel Adaptor

## 6979 Stud Elbow, Male BSPT Thread



Bio-based polymer, stainless steel 316L, EPDM

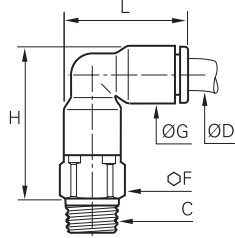

ØD	C		F	G	H	L	kg
4	R1/8	6979 04 10	10	8.5	23	19	0.008
	R1/4	6979 04 13	14	8.5	23.5	19	0.018
6	R1/8	6979 06 10	10	10.5	27	22.5	0.010
	R1/4	6979 06 13	14	10.5	27.5	22.5	0.020
8	R1/8	6979 08 10	13	13.5	33.5	29.5	0.018
	R1/4	6979 08 13	14	13.5	32.5	29.5	0.022
	R3/8	6979 08 17	17	13.5	33	29.5	0.032
10	R1/4	6979 10 13	15	16	39.5	34	0.031
	R3/8	6979 10 17	17	16	39.5	34	0.041
12	R1/2	6979 12 21	21	16	39.5	34	0.060
	R3/8	6979 12 17	19	19	45.5	40.5	0.051
	R1/2	6979 12 21	21	19	45.5	40.5	0.065

The body swivels for positioning purposes.

## 6958 Stud Branch Tee, Male BSPP and Metric Thread



Bio-based polymer, stainless steel 316L, EPDM

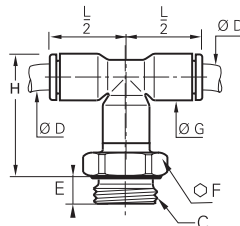

ØD	C		E	F	G	H	L/2	kg
4	M5x0.8	6958 04 19	3.5	10	8.5	24	14	0.006
	G1/8	6958 04 10	5	13	8.5	22	14	0.009
	G1/4	6958 04 13	5.5	16	8.5	22	14	0.014
6	M5x0.8	6958 06 19	3.5	10	10.5	30	16	0.009
	G1/8	6958 06 10	5	13	10.5	28.5	16	0.011
	G1/4	6958 06 13	5.5	16	10.5	28.5	16	0.016
8	G1/8	6958 08 10	4.5	13	13.5	38	23	0.019
	G1/4	6958 08 13	5.5	16	13.5	36	23	0.022
	G3/8	6958 08 17	5.5	21	13.5	36	23	0.030
10	G1/4	6958 10 13	5.5	16	16	43	26.5	0.032
	G3/8	6958 10 17	5.5	21	16	43	26.5	0.055
	G1/2	6958 10 21	7.5	24	16	43	26.5	0.051
12	G3/8	6958 12 17	5.5	21	19	45.5	31	0.042
	G1/2	6958 12 21	7	24	19	45.5	31	0.049

These products are available upon request, with minimum order quantity of 100 pieces.  
The body swivels for positioning purposes.

## 6978 Stud Branch Tee, Male BSPT Thread



Bio-based polymer, stainless steel 316L, EPDM

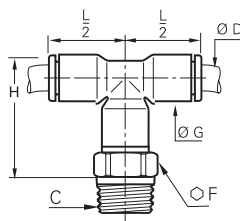

ØD	C		F	G	H	L/2	kg
4	R1/8	6978 04 10	10	8.5	17	14	0.009
	R1/4	6978 04 13	14	8.5	17	14	0.020
6	R1/8	6978 06 10	10	10.5	23	16	0.011
	R1/4	6978 06 13	14	10.5	23	16	0.011
8	R1/8	6978 08 10	13	13.5	30	23	0.020
	R1/4	6978 08 13	14	13.5	30	23	0.025
	R3/8	6978 08 17	17	13.5	30	23	0.036
10	R1/4	6978 10 13	15	16	34.5	26.5	0.033
	R3/8	6978 10 17	17	16	34.5	26.5	0.043
12	R1/2	6978 12 21	21	16	34.5	26.5	0.065
	R3/8	6978 12 17	19	19	40.5	31	0.053
	R1/2	6978 12 21	21	19	40.5	31	0.061

These products are available upon request, with minimum order quantity of 100 pieces.  
The body swivels for positioning purposes.

# Stud Fittings with Stainless Steel Adaptor

## 6953 Stud Run Tee, Male BSPP and Metric Thread



Bio-based polymer, stainless steel 316L, EPDM

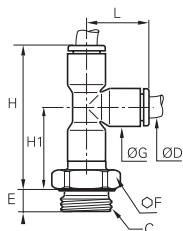

ØD	C		E	F	G	H	H1	L	kg
4	M5x0.8	<a href="#">6953 04 19</a>	3.5	10	8.5	32	19	14.5	0.006
	G1/8	<a href="#">6953 04 10</a>	5	13	8.5	30	18	14.5	0.009
	G1/4	<a href="#">6953 04 13</a>	5.5	16	8.5	30	18	14.5	0.014
6	M5x0.8	<a href="#">6953 06 19</a>	3.5	10	10.5	39	23	17.5	0.009
	G1/8	<a href="#">6953 06 10</a>	5	13	10.5	38	22	17.5	0.011
	G1/4	<a href="#">6953 06 13</a>	5.5	16	10.5	38	22	17.5	0.016
8	G1/8	<a href="#">6953 08 10</a>	4.5	13	13.5	54	31	23	0.019
	G1/4	<a href="#">6953 08 13</a>	5.5	16	13.5	52	29	23	0.022
	G3/8	<a href="#">6953 08 17</a>	5.5	21	13.5	52	29	23	0.030
10	G1/4	<a href="#">6953 10 13</a>	5.5	16	16	61	35	26.5	0.032
	G3/8	<a href="#">6953 10 17</a>	5.5	21	16	61	35	26.5	0.055
	G1/2	<a href="#">6953 10 21</a>	7.5	24	16	61	35	26.5	0.051
12	G3/8	<a href="#">6953 12 17</a>	5.5	21	19	67	36	31	0.042
	G1/2	<a href="#">6953 12 21</a>	7	24	19	67	36	31	0.049

These products are available upon request, with minimum order quantity of 100 pieces.  
The body swivels for positioning purposes.

## 6973 Stud Run Tee, Male BSPT Thread



Bio-based polymer, stainless steel 316L, EPDM

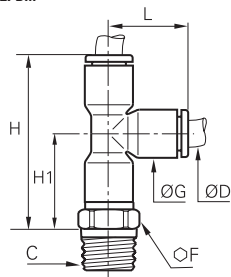

ØD	C		F	G	H	H1	L	kg
4	R1/8	<a href="#">6973 04 10</a>	10	8.5	31	18	14.5	0.009
	R1/4	<a href="#">6973 04 13</a>	14	8.5	31	19	14.5	0.020
6	R1/8	<a href="#">6973 06 10</a>	10	10.5	38	22	17.5	0.011
	R1/4	<a href="#">6973 06 13</a>	14	10.5	39	23	17.5	0.011
8	R1/8	<a href="#">6973 08 10</a>	13	13.5	53	30	23	0.020
	R1/4	<a href="#">6973 08 13</a>	14	13.5	52	29	23	0.025
10	R3/8	<a href="#">6973 08 17</a>	17	13.5	52	29	23	0.036
	R1/4	<a href="#">6973 10 13</a>	15	16	61	35	26.5	0.033
	R3/8	<a href="#">6973 10 17</a>	17	16	61	35	26.5	0.043
12	R1/2	<a href="#">6973 10 21</a>	21	16	61	35	26.5	0.065
	R3/8	<a href="#">6973 12 17</a>	19	19	70	39	31	0.053
	R1/2	<a href="#">6973 12 21</a>	21	19	70	39	31	0.061

These products are available upon request, with minimum order quantity of 100 pieces.  
The body swivels for positioning purposes.

# Stud Fittings with FDA Chemical Nickel-Plated Brass Adaptor

## 6901 Stud Fitting, Male BSPP and Metric Thread



FDA chemical nickel-plated brass, EPDM

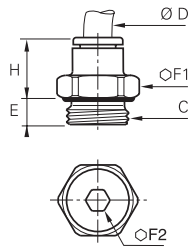

ØD	C		E	F	F1	H	kg
4	M5x0.8	<a href="#">6901 04 19</a>	3	8	2.5	14	0.003
	G1/8	<a href="#">6901 04 10</a>	5.5	13	3	11.5	0.007
	G1/4	<a href="#">6901 04 13</a>	5.5	16	3	10.5	0.011
6	M5x0.8	<a href="#">6901 06 19</a>	3	10	2.5	16	0.005
	G1/8	<a href="#">6901 06 10</a>	4.5	13	4	13	0.007
	G1/4	<a href="#">6901 06 13</a>	5.5	16	4	12.5	0.011
8	G1/8	<a href="#">6901 08 10</a>	4.5	13	5	20.5	0.011
	G1/4	<a href="#">6901 08 13</a>	5.5	16	6	19.5	0.016
	G3/8	<a href="#">6901 08 17</a>	5.5	20	6	18	0.022
10	G1/4	<a href="#">6901 10 13</a>	5.5	16	7	23	0.018
	G3/8	<a href="#">6901 10 17</a>	5.5	20	8	19.5	0.021
	G1/2	<a href="#">6901 10 21</a>	7	24	8	18	0.033
12	G3/8	<a href="#">6901 12 17</a>	5.5	20	9	27	0.029
	G1/2	<a href="#">6901 12 21</a>	7	24	10	22.5	0.035

## 6905 Stud Fitting, Male BSPT Thread



FDA chemical nickel-plated brass, EPDM

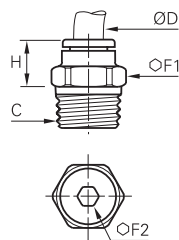

ØD	C		F	F1	H	kg
4	R1/8	<a href="#">6905 04 10</a>	10	3	9.5	0.005
	R1/4	<a href="#">6905 04 13</a>	14	3	6.5	0.012
6	R1/8	<a href="#">6905 06 10</a>	10	4	11.5	0.005
	R1/4	<a href="#">6905 06 13</a>	14	4	8.5	0.011
8	R1/8	<a href="#">6905 08 10</a>	13	5	20	0.011
	R1/4	<a href="#">6905 08 13</a>	14	6	17	0.014
	R3/8	<a href="#">6905 08 17</a>	17	6	13	0.021
10	R1/4	<a href="#">6905 10 13</a>	16	7	20	0.017
	R3/8	<a href="#">6905 10 17</a>	17	8	16.5	0.019
	R1/2	<a href="#">6905 10 21</a>	21	8	14	0.037
12	R3/8	<a href="#">6905 12 17</a>	19	9	24	0.028
	R1/2	<a href="#">6905 12 21</a>	21	10	19.5	0.036

## 6999 Stud Elbow, Male BSPP and Metric Thread



Bio-based polymer, FDA chemical nickel-plated brass, EPDM

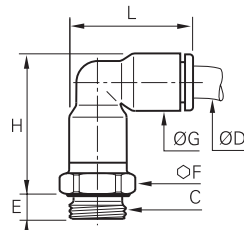

ØD	C		E	F	G	H	L	kg
4	M5x0.8	<a href="#">6999 04 19</a>	3.5	8	8.5	23	19	0.005
	G1/8	<a href="#">6999 04 10</a>	4.5	13	8.5	22.5	19	0.009
	G1/4	<a href="#">6999 04 13</a>	5.5	16	8.5	22.5	19	0.014
6	M5x0.8	<a href="#">6999 06 19</a>	3.5	10	10.5	26.5	22.5	0.008
	G1/8	<a href="#">6999 06 10</a>	4.5	13	10.5	26.5	22.5	0.011
	G1/4	<a href="#">6999 06 13</a>	5.5	16	10.5	26.5	22.5	0.016
8	G1/8	<a href="#">6999 08 10</a>	4.5	13	13.5	35	29.5	0.018
	G1/4	<a href="#">6999 08 13</a>	5.5	16	13.5	33	29.5	0.020
	G3/8	<a href="#">6999 08 17</a>	5.5	20	13.5	33	29.5	0.028
10	G1/4	<a href="#">6999 10 13</a>	5.5	16	16	40.5	34	0.029
	G3/8	<a href="#">6999 10 17</a>	5.5	20	16	39	34	0.037
	G1/2	<a href="#">6999 10 21</a>	7	24	16	39	34	0.042
12	G3/8	<a href="#">6999 12 17</a>	5.5	20	19	42	40	0.040
	G1/2	<a href="#">6999 12 21</a>	7	24	19	42	40	0.049

The body swivels for positioning purposes.



# Stud Fittings with FDA Chemical Nickel-Plated Brass Adaptor

## 6909 Stud Elbow, Male BSPT Thread



Bio-based polymer, FDA chemical nickel-plated brass, EPDM

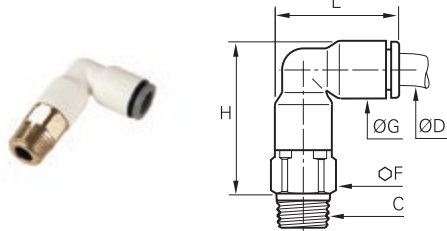

ØD	C		F	G	H	L	kg
4	R1/8	<a href="#">6909 04 10</a>	10	8.5	23	19	0.008
	R1/4	<a href="#">6909 04 13</a>	14	8.5	23.5	19	0.018
6	R1/8	<a href="#">6909 06 10</a>	10	10.5	27	22.5	0.010
	R1/4	<a href="#">6909 06 13</a>	14	10.5	27.5	22.5	0.020
8	R1/8	<a href="#">6909 08 10</a>	13	13.5	33.5	29.5	0.018
	R1/4	<a href="#">6909 08 13</a>	14	13.5	32.5	29.5	0.022
	R3/8	<a href="#">6909 08 17</a>	17	13.5	33	29.5	0.032
10	R1/4	<a href="#">6909 10 13</a>	15	16	39.5	34	0.031
	R3/8	<a href="#">6909 10 17</a>	17	16	39.5	34	0.041
12	R1/2	<a href="#">6909 12 21</a>	21	16	39.5	34	0.060
	R3/8	<a href="#">6909 12 17</a>	19	19	45.5	40.5	0.051
	R1/2	<a href="#">6909 12 21</a>	21	19	45.5	40.5	0.065

The body swivels for positioning purposes.

## 6998 Stud Branch Tee, Male BSPP and Metric Thread



Bio-based polymer, FDA chemical nickel-plated brass, EPDM

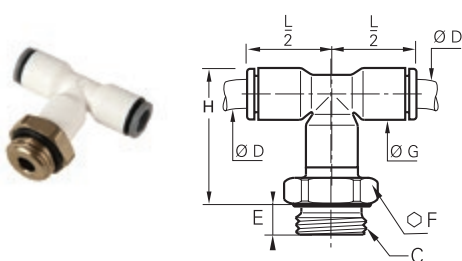

ØD	C		E	F	G	H	L/2	kg
4	M5x0.8	<a href="#">6998 04 19</a>	3.5	8	8.5	24	14	0.006
	G1/8	<a href="#">6998 04 10</a>	5	13	8.5	22	14	0.009
	G1/4	<a href="#">6998 04 13</a>	5.5	16	8.5	22	14	0.014
6	M5x0.8	<a href="#">6998 06 19</a>	3.5	10	10.5	30	16	0.009
	G1/8	<a href="#">6998 06 10</a>	5	13	10.5	29	16	0.011
	G1/4	<a href="#">6998 06 13</a>	5.5	16	10.5	29	16	0.016
8	G1/8	<a href="#">6998 08 10</a>	4.5	13	13.5	38	23	0.019
	G1/4	<a href="#">6998 08 13</a>	5.5	16	13.5	36	23	0.022
	G3/8	<a href="#">6998 08 17</a>	5.5	20	13.5	36	23	0.030
10	G1/4	<a href="#">6998 10 13</a>	5.5	16	16	43	26.5	0.032
	G3/8	<a href="#">6998 10 17</a>	5.5	20	16	43	26.5	0.055
	G1/2	<a href="#">6998 10 21</a>	7.5	24	16	43	26.5	0.051
12	G3/8	<a href="#">6998 12 17</a>	5.5	20	19	45.5	31	0.042
	G1/2	<a href="#">6998 12 21</a>	7	24	19	45.5	31	0.049

These products are available upon request, with minimum order quantity of 100 pieces.  
The body swivels for positioning purposes.

## 6908 Stud Branch Tee, Male BSPT Thread



Bio-based polymer, FDA chemical nickel-plated brass, EPDM

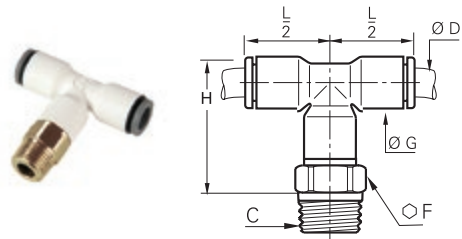

ØD	C		F	G	H	L/2	kg
4	R1/8	<a href="#">6908 04 10</a>	10	8.5	17	14	0.009
	R1/4	<a href="#">6908 04 13</a>	14	8.5	17	14	0.020
6	R1/8	<a href="#">6908 06 10</a>	10	10.5	23	16	0.011
	R1/4	<a href="#">6908 06 13</a>	14	10.5	23	16	0.011
8	R1/8	<a href="#">6908 08 10</a>	13	13.5	30	23	0.020
	R1/4	<a href="#">6908 08 13</a>	14	13.5	30	23	0.025
	R3/8	<a href="#">6908 08 17</a>	17	13.5	30	23	0.036
10	R1/4	<a href="#">6908 10 13</a>	15	16	34.5	26.5	0.033
	R3/8	<a href="#">6908 10 17</a>	17	16	34.5	26.5	0.043
	R1/2	<a href="#">6908 10 21</a>	21	16	34.5	26.5	0.065
12	R3/8	<a href="#">6908 12 17</a>	19	19	40.5	31	0.053
	R1/2	<a href="#">6908 12 21</a>	21	19	40.5	31	0.061

These products are available upon request, with minimum order quantity of 100 pieces.  
The body swivels for positioning purposes.

# Stud Fittings with FDA Chemical Nickel-Plated Brass Adaptor

## 6993 Stud Run Tee, Male BSPP and Metric Thread



Bio-based polymer, FDA chemical nickel-plated brass, EPDM

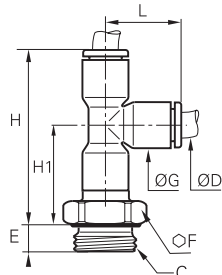

ØD	C		E	F	G	H	H1	L	kg
4	M5x0.8	<a href="#">6993 04 19</a>	3.5	8	8.5	32	19	14.5	0.006
	G1/8	<a href="#">6993 04 10</a>	5	13	8.5	30	18	14.5	0.009
	G1/4	<a href="#">6993 04 13</a>	5.5	16	8.5	30	18	14.5	0.014
6	M5x0.8	<a href="#">6993 06 19</a>	3.5	10	10.5	39	23	17.5	0.009
	G1/8	<a href="#">6993 06 10</a>	5	13	10.5	38	22	17.5	0.011
	G1/4	<a href="#">6993 06 13</a>	5.5	16	10.5	38	22	17.5	0.016
8	G1/8	<a href="#">6993 08 10</a>	4.5	13	13.5	54	31	23	0.019
	G1/4	<a href="#">6993 08 13</a>	5.5	16	13.5	52	29	23	0.022
	G3/8	<a href="#">6993 08 17</a>	5.5	20	13.5	52	29	23	0.030
10	G1/4	<a href="#">6993 10 13</a>	5.5	16	16	61	35	26.5	0.032
	G3/8	<a href="#">6993 10 17</a>	5.5	20	16	61	35	26.5	0.055
	G1/2	<a href="#">6993 10 21</a>	7.5	24	16	61	35	26.5	0.051
12	G3/8	<a href="#">6993 12 17</a>	5.5	20	19	67	36	31	0.042
	G1/2	<a href="#">6993 12 21</a>	7	24	19	67	36	31	0.049

These products are available upon request, with minimum order quantity of 100 pieces.  
The body swivels for positioning purposes.

## 6903 Stud Run Tee, Male BSPT Thread



Bio-based polymer, FDA chemical nickel-plated brass, EPDM

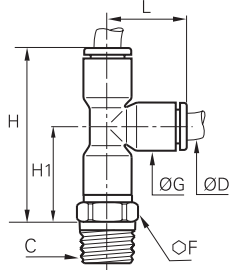

ØD	C		F	G	H	H1	L	kg
4	R1/8	<a href="#">6903 04 10</a>	10	8.5	31	18	14.5	0.009
	R1/4	<a href="#">6903 04 13</a>	14	8.5	31	19	14.5	0.020
6	R1/8	<a href="#">6903 06 10</a>	10	10.5	38	22	17.5	0.011
	R1/4	<a href="#">6903 06 13</a>	14	10.5	39	23	17.5	0.011
8	R1/8	<a href="#">6903 08 10</a>	13	13.5	53	30	23	0.020
	R1/4	<a href="#">6903 08 13</a>	14	13.5	52	29	23	0.025
10	R3/8	<a href="#">6903 08 17</a>	17	13.5	52	29	23	0.036
	R1/4	<a href="#">6903 10 13</a>	15	16	61	35	26.5	0.033
	R3/8	<a href="#">6903 10 17</a>	17	16	61	35	26.5	0.043
12	R1/2	<a href="#">6903 10 21</a>	21	16	61	35	26.5	0.065
	R3/8	<a href="#">6903 12 17</a>	19	19	70	39	31	0.053
	R1/2	<a href="#">6903 12 21</a>	21	19	70	39	31	0.061

These products are available upon request, with minimum order quantity of 100 pieces.  
The body swivels for positioning purposes.

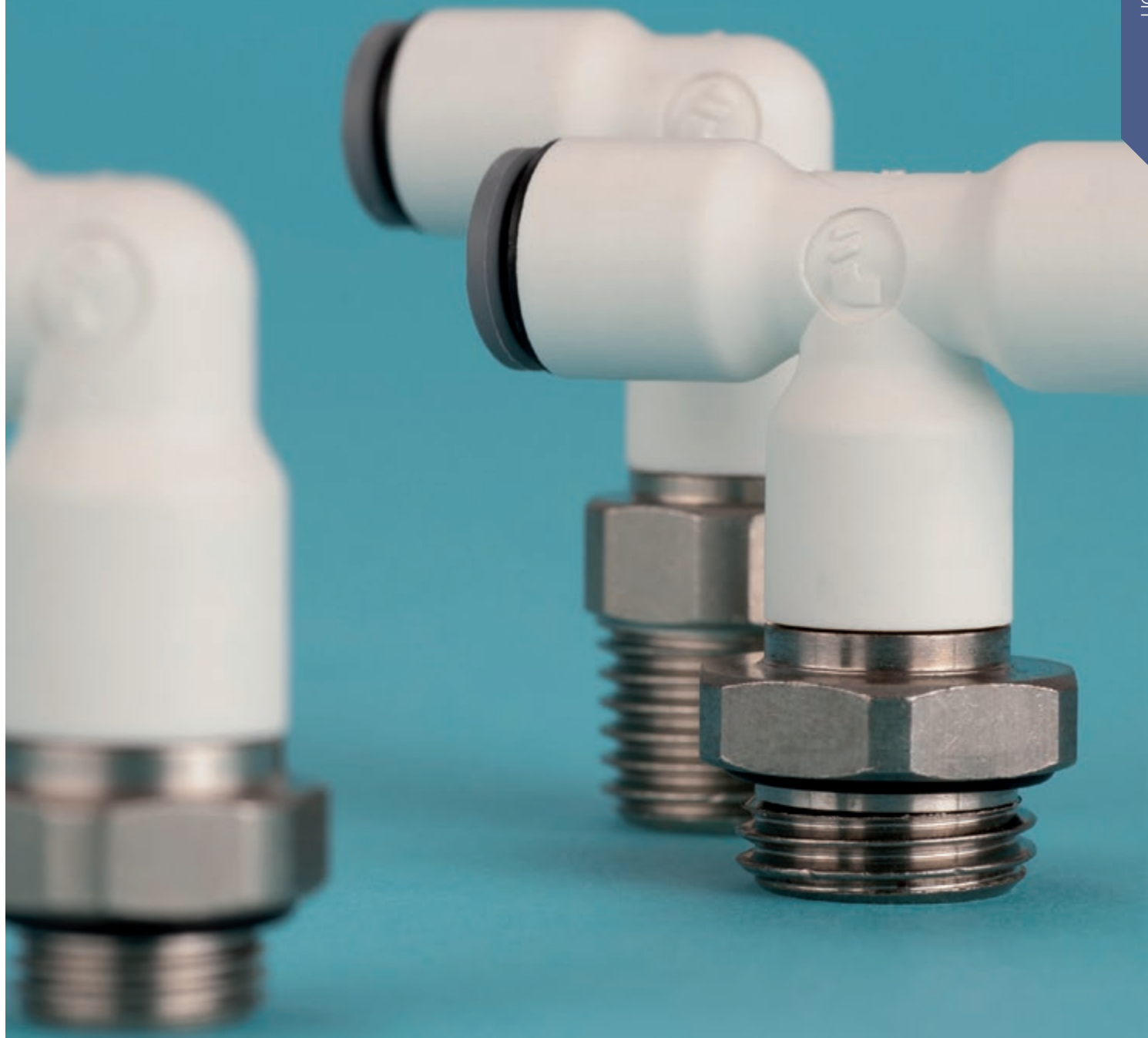

LIQUIFF®

Push-In Fittings



# Connectors for Optic Fibre Cable

## Direct Buried Connectors and End Caps

- 6270**  
Page 1-75
- 6270..03**  
Page 1-75
- 6273**  
Page 1-75
- 6273..03**  
Page 1-75



## Direct Install Connectors and End Caps

- 6271**  
Page 1-77
- 6271..03**  
Page 1-77
- 3151**  
Page 1-77
- 3151..03**  
Page 1-77



## Passive Gas Block Connectors

- 6274**  
Page 1-79



## Accessories for Direct Buried and Direct Install Connectors

- 3130**  
Page 1-81
- 6276**  
Page 1-81



# Direct Buried Connectors

The new Parker Legris connectors were developed to optimise installation and provide long-term **integrity for underground FTTx\* networks**.



\*FTTx: Fibre To The x = home, building, campus, etc.

## Product Advantages

### Optimised Installation

- Transparent: optic fibre ducts and correct tube connection can be seen and verified
- Patented ridged design for unsurpassed shock resistance
- No protection cap necessary
- 1 connector for 2 different wall thicknesses of the tubing (bridging possible between direct buried and direct install micro-tubing)
- Compact design and intuitive installation
- Pre-assembled safety clip to prevent risk of accidental disconnection
- High working pressure for increased blowing speed/distance

### Longevity & Reliability

- Tried-and-tested connection technology to ensure tensile strength and resistance to network expansion
- Perfect sealing IP68: full protection against particle ingress
- UL94: flame resistance for indoor installations
- Date coding to guarantee quality and traceability
- 100% leak-tested in production



Underground Networks  
Micro-Tubing  
Air Blowing  
Water Floating  
Heavy Duty Ducting

Applications

## Technical Characteristics

<b>Compatible Fluids</b>	Air, water
<b>Working Pressure</b>	Vacuum to 25 bar
<b>Working Temperature</b>	-20°C to +80°C
<b>Suitable Ducts</b>	Direct buried micro-tubing Direct install micro-tubing
<b>Shock Resistance</b>	Conforms to standard and light applications according to the NF EN 61386-24 standard
<b>Tubing Diameter</b>	Ø 7 mm to Ø 14 mm

Use is guaranteed with a vacuum of 755 mm Hg (99% vacuum).

### Component Materials

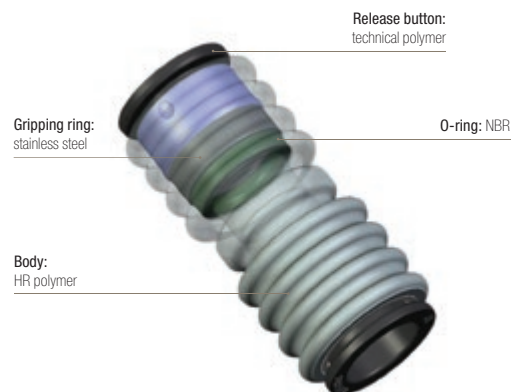

### Regulations and Intellectual Property

ISO 14743: Pneumatic fluid power, push-in connectors for thermoplastic tubes  
NF EN 50086-2-4 replaced by NF EN 61386-24: Standard relating to impact tests for buried systems  
UL94: Flame resistance

IP68: Seepage resistance to water and dust  
Patent family FR2980999 (buried connectors)  
Patent family FR2924194 (safety clips)

# Direct Buried Connectors

## 6270 Equal and Unequal Tube-to-Tube Connector

HR polymer, NBR

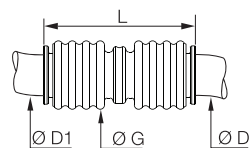

ØD	ØD1		G	L	Kg
7	7	<a href="#">6270 07 00</a>	16	38	0.006
8	8	<a href="#">6270 08 00</a>	16	39	0.006
10	10	<a href="#">6270 10 00</a>	20	43	0.009
	12	<a href="#">6270 10 12</a>	22	50	0.010
12	12	<a href="#">6270 12 00</a>	22	50	0.009
	14	<a href="#">6270 12 14</a>	24	56	0.022
14	14	<a href="#">6270 14 00</a>	24	56	0.022

16 mm also available upon request

## 6270..03 Equal and Unequal Tube-to-Tube Connector with Red Tamper-Proof Safety Clips

HR polymer, NBR

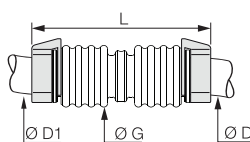

ØD	ØD1		G	L	Kg
7	7	<a href="#">6270 07 00 03</a>	16	47	0.007
8	8	<a href="#">6270 08 00 03</a>	16	48	0.007
10	10	<a href="#">6270 10 00 03</a>	20	51	0.011
	12	<a href="#">6270 10 12 03</a>	22	60	0.026
12	12	<a href="#">6270 12 00 03</a>	22	60	0.017
	14	<a href="#">6270 12 14 03</a>	24	68	0.031
14	14	<a href="#">6270 14 00 03</a>	24	68	0.023

This product is available on request only.

## 6273 End Cap

HR polymer, NBR

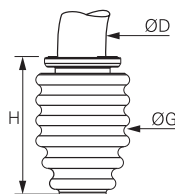

ØD		G	H	Kg
7	<a href="#">6273 07 00</a>	16	23	0.002
8	<a href="#">6273 08 00</a>	16	24	0.002
10	<a href="#">6273 10 00</a>	20	26	0.003
12	<a href="#">6273 12 00</a>	22	30	0.006
14	<a href="#">6273 14 00</a>	24	33	0.014

16 mm also available upon request

## 6273..03 End Cap with Red Tamper-Proof Safety Clip

HR polymer, NBR

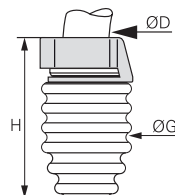

ØD		G	H	Kg
7	<a href="#">6273 07 00 03</a>	16	28	0.003
8	<a href="#">6273 08 00 03</a>	16	29	0.003
10	<a href="#">6273 10 00 03</a>	20	31	0.005
12	<a href="#">6273 12 00 03</a>	22	35	0.009
14	<a href="#">6273 14 00 03</a>	24	39	0.018

This product is available on request only.



# Direct Install Connectors

A range of high performance connectors dedicated to direct install systems for FTTx\* to guarantee **easy use** and **long service time**.



\*FTTx: Fibre To The x = home, building, campus, etc.

## Product Advantages

### Optimised Installation

- Reliable technology of push-in connection
- Minimum distance between two tubes when connected, eliminating the risk of blockage during blowing
- 1 connector for 2 different wall thicknesses of the tubing (bridging possible between direct buried and direct install micro-tubing)
- Ultra compact design and intuitive installation
- Safety clip for preventing risk of accidental disconnection

### Longevity & Reliability

- Tried-and-tested connection technology to ensure capability to expand network
- Perfect sealing IP68: full protection against particle ingress
- UL94 V-2: flame resistance for indoor installations
- Date coding to guarantee quality and traceability
- 100% leak-tested in production



Direct Install Networks  
Micro-Tubing  
Air Blowing  
Aerial Ducting  
Sub-Ducts

Applications

## Technical Characteristics

Compatible Fluids	Air, water
Working Pressure	Vacuum to 15 bar
Working Temperature Storage temperature	-15°C to +45°C -20°C to +80°C
Suitable Ducts	Direct install microduct
Tubing Diameter	Ø 5 mm to Ø 14 mm

Use is guaranteed with a vacuum of 755 mm Hg (99% vacuum).

### Component Materials



### Regulations and Intellectual Property

- ISO 14743: Pneumatic fluid power, push-in connectors for thermoplastic tubes
- IP68: Seepage resistance to water and dust
- UL94 V-2: Flame resistance
- Patent family FR2924194 (safety clips)

# Direct Install Connectors and End Caps

## 6271 Equal Tube-to-Tube Connector

HR polymer, NBR

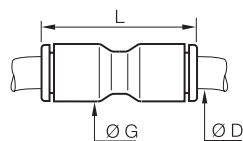

ØD		G	L	Kg
5	<a href="#">6271 05 00</a>	10.5	30	0.002
7	<a href="#">6271 07 00</a>	13.5	38	0.004
8	<a href="#">6271 08 00</a>	13.5	38	0.004
10	<a href="#">6271 10 00</a>	16	42	0.006
12	<a href="#">6271 12 00</a>	19	50.5	0.009
14	<a href="#">6271 14 00</a>	22	56	0.014

16 mm also available upon request

## 6271..03 Equal Tube-to-Tube Connector with Red Tamper-Proof Safety Clips

HR polymer, NBR

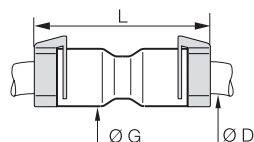

ØD		G	L	Kg
5	<a href="#">6271 05 00 03</a>	10.5	38	0.007
7	<a href="#">6271 07 00 03</a>	13.5	47	0.007
8	<a href="#">6271 08 00 03</a>	13.5	48	0.007
10	<a href="#">6271 10 00 03</a>	16	51	0.011
12	<a href="#">6271 12 00 03</a>	19	60	0.017
14	<a href="#">6271 14 00 03</a>	22	68	0.025

This product is available on request only.

## 3151 End Cap

Technical polymer, NBR

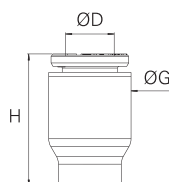

ØD		G	H	Kg
5	<a href="#">3151 05 00</a>	10.5	17	0.001
7	<a href="#">3151 07 00</a>	13.5	22	0.003
8	<a href="#">3151 08 00</a>	13.5	22	0.003
10	<a href="#">3151 10 00</a>	16	22	0.005
12	<a href="#">3151 12 00</a>	19	28	0.009
14	<a href="#">3151 14 00</a>	22	31	0.018

Technical specifications of LF 3000® push-in fittings.

## 3151..03 End Cap with Tamper-Proof Safety Clip

Technical polymer, NBR

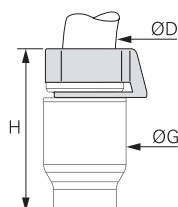

ØD		G	H	Kg
5	<a href="#">3151 05 00 03</a>	10.5	20	0.002
7	<a href="#">3151 07 00 03</a>	13.5	26	0.004
8	<a href="#">3151 08 00 03</a>	13.5	26	0.004
10	<a href="#">3151 10 00 03</a>	16	27	0.007
12	<a href="#">3151 12 00 03</a>	19	33	0.011
14	<a href="#">3151 14 00 03</a>	22	35	0.022

This product is available on request only.

Technical specifications of LF 3000® push-in fittings.

### Related Products

- Tube Cutters: see chapter "Technical Tubes and Hoses"

[3000 71 00](#) P. 3-46

[3000 71 11](#) P. 3-46

# Passive Gas Block Connector

**Easy-to-use** product, providing **quick** and **efficient** sealing of the end of the FTTx\* network and thereby long-term protection of the installation.



\*FTTx: Fibre To The x = home, building, campus, etc.

## Product Advantages

- Stock Optimisation** | More possibilities with fewer references  
 1 connector allows for several microduct/fibre cable combinations
- Easy Handling** | Optic fibre cable visible as it passes through seal, allowing for considerable time-saving  
 Visual connection indication  
 100% push-in technology with optic fibre cable sealing  
 Ultra compact design
- Longevity & Reliability** | Unique design guaranteeing maximum safety of use  
 Gas and watertight up to 1 bar  
 UL94 V-2: flame resistance for indoor installations  
 Safety clip for preventing risk of accidental disconnection



- Applications**
- Underground Networks
  - Micro-Tubing
  - Air Blowing
  - Water Floating
  - Heavy Duty Ducting

## Technical Characteristics

<b>Compatible Fluids</b>	Air, water
<b>Sealing Level</b>	1 bar
<b>Working Temperature</b> <b>Storage Temperature</b>	-15°C to +45°C -20°C to +80°C
<b>Suitable Ducts</b>	Direct buried and direct install microducts
<b>Tubing Diameter</b>	Ø 5 mm to Ø 14 mm

### Component Materials



### Regulations

- ISO 14743: Pneumatic fluid power, push-in connectors for thermoplastic tubes
- IP68: Seepage resistance to water and dust
- UL94 V-2: Flame resistance for indoor installation or hazardous zones
- Patent family FR2924194 (gas block)

# Passive Gas Block Connector

**6274**

Passive Gas Block Connector

HR polymer, NBR

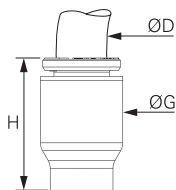

ØD		G	H	Kg
5	<a href="#">6274 05 00</a>	10.5	17	0.001
7	<a href="#">6274 07 00</a>	13.5	22	0.003
10	<a href="#">6274 10 00</a>	16	22	0.005
12	<a href="#">6274 12 00</a>	19	28	0.009
14	<a href="#">6274 14 00</a>	22	31	0.018

## Installation Process



1. Slide the Gas Block Connector onto the optic fibre cable.



*Centering and turning the connector facilitates the passage of the largest optic fibre cable possible through the Gas Block.*



2. Push the connector onto the microduct tubing.

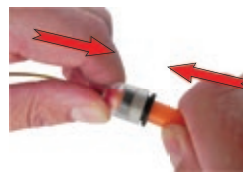

3. Press the connector very firmly, straight onto the tubing, and compress the seal.



4. Check: the optic fibre cable should be held tightly by the seal.  
*The cable can still slide, allowing its length to be adjusted out of the Gas Block if necessary.*

## Microduct/Fibre Cable Combination

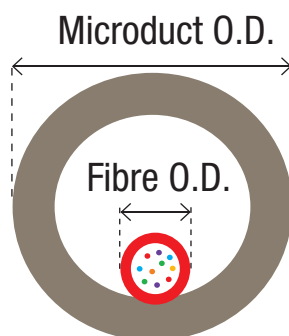

Connector / Microduct O.D (mm)	Fibre O.D. (mm)
5	1 to 2.5
7	1 to 4
10	1.4 to 6.5
12	3 to 8,6
14	3 to 9

We recommend the use of a safety clip in order to prevent accidental disconnection.

# Accessories for Direct Buried and Direct Install Connectors

Parker Legris has designed different accessories to improve **safety** and allow circuit **identification**.

## Product Advantages

### Tamper-Proof Safety Clip

- Prevents accidental disconnection
- Disconnection only possible with tooling
- Resistant to grease and cleaning agents
- Colour-coding for tube identification (6 colours)
- Adapted to suit all installation configurations



### Detectable Buried End Cap

- Easy detection of loose underground network's termination
- Cost and time saving when maintaining or expanding the network
- Metal cover locks to plastic end cap during microduct connection to enable visual detection of correct positioning over time

- Applications**
- Underground Networks
  - Micro-Tubing
  - Air Blowing
  - Water Floating
  - Heavy Duty Ducting

## Technical Characteristics

	Detectable Buried End Cap
Working Temperature	Vacuum to 25 bar
Working Temperature	-20°C to +80°C
Suitable Ducts	Direct install and direct buried
Tubing Diameter	Ø 7 mm to Ø 14 mm

### Component Materials



## Installation Process

### Tamper-Proof Safety Clip

#### Connection



1. Assemble the clip



2. Connect the tubing

#### Disconnection



1. Cut the clip with pliers



2. Remove the clip and tubing

### Detectable Buried End Cap



1. A cap, a clip and a metal cover



2. Assemble the clip on the cap



3. Mount the cap within the metal cover



4. Connect the tube

# Accessories for Direct Buried and Direct Install Connectors

## 3130 Tamper-Proof Safety Clip

Technical polymer

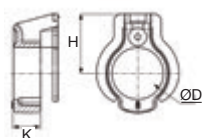

ØD							H	K	Kg
4	<a href="#">3130 04 01</a>	<a href="#">3130 04 02</a>	<a href="#">3130 04 03</a>	<a href="#">3130 04 04</a>	<a href="#">3130 04 05</a>	<a href="#">3130 04 10</a>	6.5	3	0.001
6	<a href="#">3130 06 01</a>	<a href="#">3130 06 02</a>	<a href="#">3130 06 03</a>	<a href="#">3130 06 04</a>	<a href="#">3130 06 05</a>	<a href="#">3130 06 10</a>	8	3	0.001
8	<a href="#">3130 08 01</a>	<a href="#">3130 08 02</a>	<a href="#">3130 08 03</a>	<a href="#">3130 08 04</a>	<a href="#">3130 08 05</a>	<a href="#">3130 08 10</a>	9.5	4.3	0.001
10	<a href="#">3130 10 01</a>	<a href="#">3130 10 02</a>	<a href="#">3130 10 03</a>	<a href="#">3130 10 04</a>	<a href="#">3130 10 05</a>	<a href="#">3130 10 10</a>	10.8	4.2	0.001
12	<a href="#">3130 12 01</a>	<a href="#">3130 12 02</a>	<a href="#">3130 12 03</a>	<a href="#">3130 12 04</a>	<a href="#">3130 12 05</a>	<a href="#">3130 12 10</a>	12.5	5.1	0.004
14	<a href="#">3130 14 01</a>	<a href="#">3130 14 02</a>	<a href="#">3130 14 03</a>	<a href="#">3130 14 04</a>	<a href="#">3130 14 05</a>	<a href="#">3130 14 10</a>	15	6	0.004

## 6276 Detectable Buried End Cap

Technical polymer, steel, NBR

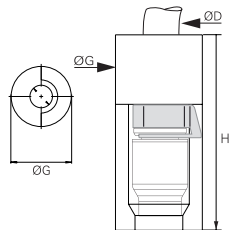

ØD		G	H	Kg
7	<a href="#">6276 07 00</a>	20	45	0.054
8	<a href="#">6276 08 00</a>	20	45	0.054
10	<a href="#">6276 10 00</a>	22	45	0.043
12	<a href="#">6276 12 00</a>	24	50	0.064
14	<a href="#">6276 14 00</a>	27.5	60	0.065

This product is available on request only.

## Bridging of O.D./I.D. Connector

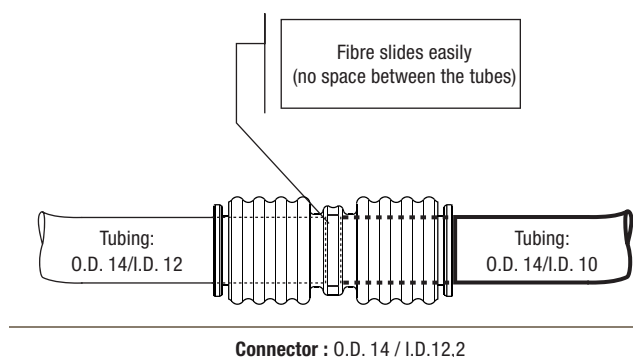

Connector O.D. (mm)/ I.D. (mm)	Tube O.D. (mm)	Tube I.D. (mm)
5 / 4	5	2.1 to 3.8
7 / 5.7	7	3 to 5.5
8 / 6.2	8	3.5 to 6
10 / 8.2	10	5.5 to 8
12 / 12.2	12	8 to 10
14 / 12.2	14	9,6 to 12





# Prestomatic Push-In Fittings

## Prestomatic 3 Fittings

### Elbows

**C68UNPMK**  
Page 1-85



**V68UNPMK**  
Page 1-85



### Tees

**R68UNPMK**  
Page 1-85



**JNPMK**  
Page 1-85



## Prestomatic 2 Stud Fittings

### Straights

**F8UNPMB**  
Page 1-87



**F2NPMB**  
Page 1-87



**WEONPMB**  
Page 1-87



### Elbows

**C8UNPMB**  
Page 1-88



**V8UNPMB**  
Page 1-88



### Tees

**S8UNPMB**  
Page 1-88



**S8UNPMBPPAM**  
Page 1-88



## Prestomatic 2 Tube-to-Tube Fittings

### Straights

**HNPMB**  
Page 1-89



**WNPMB**  
Page 1-89



### Elbow

**T2ENPMB**  
Plug-In  
Page 1-89



### Tee

**JNPMB**  
Page 1-89



## Adaptors and Accessories for Braking Systems

### Elbows

**D8C8UB**  
Page 1-90



**D8V8UB**  
Page 1-90



### Tees

**MR08UB**  
Page 1-90



**MMS8UB**  
Page 1-90



**MM08BKT**  
Page 1-90



### Increases

**F8UG8B**  
Page 1-91



### Reducers

**F8UG8B**  
Page 1-91



### Conversion Fittings

**F8UGB**  
Metric Male / NPT Female  
Page 1-91



**F8UG4B**  
Metric Male / BSPP Female  
Page 1-91



### Straight Connectors

**F8UHA8UB**  
Page 1-91



### Bulkhead Connector Fittings

**WGG88B**  
Page 1-92



**WG8F8UB**  
Page 1-92



### Test Points

**PPRF8UM**  
Page 1-92



**PPRC8UM**  
Page 1-92



**PPRV8UM**  
Page 1-92



### Plugs and Accessories

**P8UNBL**  
Page 1-93



**3126**  
Page 1-93



**VDPF8UM**  
Drain valve  
Page 1-93



**WLNB**  
Page 1-93



# Prestomatic 3 Push-In Fittings

In order to meet **severe** and **demanding** conditions of use in air circuits in rail and road transportation, this range of **lightweight** polyamide fittings offers **excellent technical performance** and respects the new environmental requirements.

## Product Advantages

- Optimum Design**
- Extreme compactness for space-saving
  - Weight reduction over traditional airbrake fittings
  - Integrated polymer tube support gives tube alignment and tube retention for:
    - excellent resistance to vibration
    - sealing ensured over time
  - Fully re-usable; reduces maintenance costs
- High Performance**
- Positive hold by an innovative gripping ring design allowing absorption of vibration and pulsating pressure
  - Excellent mechanical properties adapted to demanding working conditions
  - UV-resistant polymer guarantees a long lifespan
  - Twist-free assembly allowing free tube rotation even under pressure and high resistance to tube expansion
  - Extreme temperature resistance for increased lifespan
- Reliability**
- 100% leak-tested in production
  - Date coding to guarantee quality and traceability
  - Suitable with flexible tubing in braking system



Air Braking Systems  
Air Suspension  
Chassis  
Engine Braking  
Gearbox  
Pantograph  
Motricity Control

Applications

## Technical Characteristics

<b>Compatible Fluids</b>	Compressed air				
<b>Working Pressure</b>	25 bar				
<b>Working Temperature</b>	-40°C to +100°C For lower temperature applications, please consult us				
<b>Tightening Torques (daN.m)</b>	Threads				
	M10x1	M12x1.5	M14x1.5	M16x1.5	M22x1.5
	8 to 10	10 to 20	15 to 20	15 to 20	20 to 30

Male metric threads conform to DIN 3852-1, DIN 3852-3, ISO 4039-2 and ISO 6149-1 standards.

### Component Materials

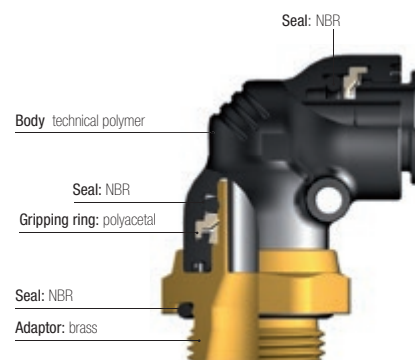

### Silicone-free

### Regulations

Fully adapted to transportation braking system applications with tubing conformed to:  
DIN 74324-1  
DIN 73378  
NF-R12-632-2

# Prestomatic 3 Push-In Fittings

## C68UNPMK

### 90° Elbow, Male Metric Thread

Technical polymer, brass, NBR

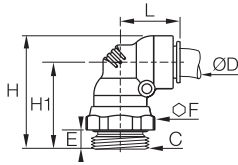

ØD	C		E	F	H	H1	L	Kg
8	M12x1.5	<a href="#">C68UNPMK8M12</a>	7.5	17	40	31	20.5	0.024
	M14x1.5	<a href="#">C68UNPMK8M14</a>	7.5	19	40	31	20.5	0.027
	M16x1.5	<a href="#">C68UNPMK8M16</a>	8	22	41	32	20.5	0.034
	M22x1.5	<a href="#">C68UNPMK8M22</a>	8	27	41	32	20.5	0.046
10	M12x1.5	<a href="#">C68UNPMK10M12</a>	7.5	17	47	36	25	0.031
	M16x1.5	<a href="#">C68UNPMK10M16</a>	8	22	47	37	25	0.043
12	M22x1.5	<a href="#">C68UNPMK10M22</a>	8	27	48	38	25	0.062
	M12x1.5	<a href="#">C68UNPMK12M12</a>	7.5	17	49	37.5	26	0.035
	M16x1.5	<a href="#">C68UNPMK12M16</a>	8	22	50	38.5	26	0.047
16	M22x1.5	<a href="#">C68UNPMK12M22</a>	8	27	50	37.5	26	0.058
	M16x1.5	<a href="#">C68UNPMK16M16</a>	8	22	53	39.5	27	0.059
	M22x1.5	<a href="#">C68UNPMK16M22</a>	8	27	53	39.5	27	0.070

The body swivels for positioning purposes.

## V68UNPMK

### 45° Elbow, Male Metric Thread

Technical polymer, brass, NBR

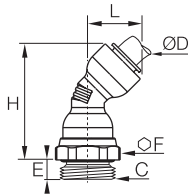

ØD	C		E	F	H	L	Kg
10	M22x1.5	<a href="#">V68UNPMK10M22</a>	8	27	61	23	0.060
12	M16x1.5	<a href="#">V68UNPMK12M16</a>	8	22	63	24.5	0.045
	M22x1.5	<a href="#">V68UNPMK12M22</a>	8	27	62	24.5	0.057
16	M22x1.5	<a href="#">V68UNPMK16M22</a>	8	27	66	27	0.071

The body swivels for positioning purposes.

## R68UNPMK

### Stud Run Tee, Male Metric Thread

Technical polymer, brass, NBR

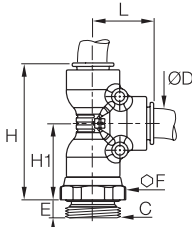

ØD	C		E	F	H	H1	L	Kg
8	M12x1.5	<a href="#">R68UNPMK8M12</a>	7.5	17	51	31	20.5	0.028
12	M16x1.5	<a href="#">R68UNPMK12M16</a>	8	22	64.5	38.5	26	0.053
16	M16x1.5	<a href="#">R68UNPMK16M16</a>	8	22	68	39.5	27	0.067

The body swivels for positioning purposes.

## JNPMK

### Equal Tee

Technical polymer, NBR

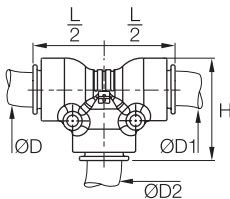

ØD	ØD1	ØD2		H	L/2	Kg
8	8	8	<a href="#">JNPMK8</a>	30	20.5	0.012
10	10	10	<a href="#">JNPMK10</a>	35.5	25	0.019
12	12	12	<a href="#">JNPMK12</a>	37.5	26	0.022
16	16	16	<a href="#">JNPMK16</a>	41	27	0.028

### Other Configurations Available on Request



F Male Elbow



90° Male Side Tee



Male Branch Tee



Male Branch Tee  
In-Line Test Point



ISO 8434-1 Bulkhead Tee

# Prestomatic 2 Push-In Fittings

To meet **severe** and **demanding applications** such as pneumatic circuits in rail and road transportation, Prestomatic 2 fittings conform to the international standards offering **robustness, reliability** and **mechanical resistance**.

## Product Advantages

- Versatility** | Extreme compactness for space-saving  
 High robustness  
 Excellent mechanical properties adapted to severe working conditions  
 Integrated metallic tube support reinforces tube alignment and tube retention for:
- excellent resistance to vibration
  - sealing ensured over time
  - increased resistance to tube removal
- Fully re-usable to reduce maintenance costs
- High Performance** | Positive hold by an innovative gripping ring design allowing absorption of vibration and pulsating pressure  
 Twist-free assembly allowing free tube rotation even under pressure and high resistance to tube expansion  
 Extreme temperature resistance: up to -50°C for increased lifespan
- Reliability** | 100% leak-tested in production  
 Date coding to guarantee quality and traceability  
 Suitable with flexible tubing in braking system



Applications

- Air Braking Systems
- Air Suspension
- Chassis
- Engine Braking
- Gearbox
- Pantograph
- Motricity Control

## Technical Characteristics

<b>Compatible Fluids</b>	Compressed air
<b>Working Pressure</b>	25 bar
<b>Working Temperature</b>	-40°C to +100°C For lower temperature applications, please consult us

Tightening Torques (daN.m)	Threads				
	M10x1	M12x1.5	M14x1.5	M16x1.5	M22x1.5
	8 to 10	10 to 20	15 to 20	15 to 20	20 to 30

Male metric threads conform to DIN 3852-1, DIN 3852-3, ISO 4039-2 and ISO 6149-1 standards.

### Component Materials

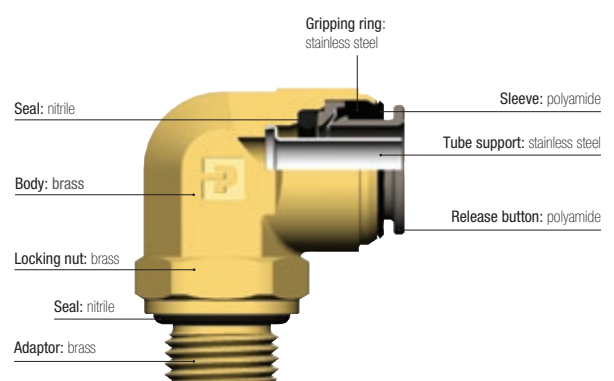

### Silicone-free

### Regulations

EN 45545-2: HL3, R22, R24, R25 classification can be attained when used with fireproof tubing

Fully adapted to transportation braking system applications with tubing:  
 DIN 74324-1  
 DIN 73378  
 NF-R12-632-2

# Stud Fittings

## F8UNPMB

### Stud Fitting, Male Metric Thread

Brass, NBR

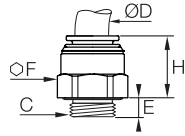

ØD	C		E	F	H	Kg
6	M10x1	<a href="#">F8UNPMB6M10</a>	7	16	18.5	0.018
	M12x1.5	<a href="#">F8UNPMB6M12</a>	7.5	17	16	0.017
	M16x1.5	<a href="#">F8UNPMB6M16</a>	8	22	14.5	0.032
8	M22x1.5	<a href="#">F8UNPMB6M22</a>	8	27	13.5	0.053
	M12x1.5	<a href="#">F8UNPMB8M12</a>	7.5	17	19.5	0.021
	M14x1.5	<a href="#">F8UNPMB8M14</a>	7.5	19	18	0.025
10	M16x1.5	<a href="#">F8UNPMB8M16</a>	8	22	15	0.030
	M22x1.5	<a href="#">F8UNPMB8M22</a>	8	27	13.5	0.052
	M12x1.5	<a href="#">F8UNPMB10M12</a>	7.5	22	22.5	0.036
12	M14x1.5	<a href="#">F8UNPMB10M14</a>	7.5	22	22	0.036
	M16x1.5	<a href="#">F8UNPMB10M16</a>	8	22	20.5	0.038
	M22x1.5	<a href="#">F8UNPMB10M22</a>	8	27	14.5	0.049
16	M12x1.5	<a href="#">F8UNPMB12M12</a>	7.5	22	22.5	0.035
	M16x1.5	<a href="#">F8UNPMB12M16</a>	8	22	21	0.033
	M22x1.5	<a href="#">F8UNPMB12M22</a>	8	27	17.5	0.052
16	M16x1.5	<a href="#">F8UNPMB16M16</a>	8	27	22.5	0.063
	M22x1.5	<a href="#">F8UNPMB16M22</a>	8	27	22.5	0.069

## F2NPMB

### Stud Fitting, Male NPT thread

Brass, NBR

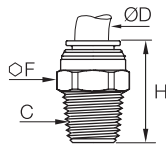

ØD	C		F	H	Kg
6	NPT1/8	<a href="#">F2NPMB6-1/8</a>	16	25	0.015
	NPT1/4	<a href="#">F2NPMB6-1/4</a>	16	25	0.020
	NPT3/8	<a href="#">F2NPMB6-3/8</a>	19	27	0.037
8	NPT1/4	<a href="#">F2NPMB8-1/4</a>	17	30	0.025
	NPT3/8	<a href="#">F2NPMB8-3/8</a>	19	27	0.033
10	NPT1/4	<a href="#">F2NPMB10-1/4</a>	22	35.5	0.044
	NPT1/2	<a href="#">F2NPMB10-1/2</a>	22	34	0.066
12	NPT3/8	<a href="#">F2NPMB12-3/8</a>	22	31	0.038
	NPT1/2	<a href="#">F2NPMB12-1/2</a>	22	34	0.058

## WEONPMB

### Equal Mixed Bulkhead Adapter

Brass, NBR

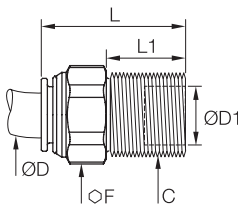

ØD	ØD1	C		F	L	L1	Kg
8	M14x1.5	<a href="#">WEONPMB8-8L</a>		19	36	21	0.033
8	10	M16x1.5	<a href="#">WEONPMB8-10L</a>	19	36	21	0.038
	12	M18x1.5	<a href="#">WEONPMB8-12L</a>	22	34	21	0.046
12	12	M18x1.5	<a href="#">WEONPMB12-12L</a>	22	37	21	0.046

### Other Configurations Available on Request



Male Bulkhead



Male Run Tee



F Male Elbow



ISO 8434-1 Bulkhead Elbow



Male Run Tee Branch Test Point

# Stud Fittings

## C8UNPMB

### 90° Elbow, Male Metric Thread

Brass, NBR

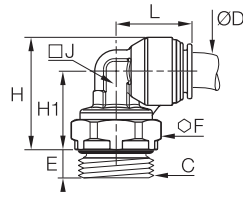

ØD	C		E	F	H	H1	J	L	Kg
6	M10x1	C8UNPMB6M10	7.5	14	24	16	10	22	0.032
	M12x1.5	C8UNPMB6M12	9	17	25.5	17	11	22	0.038
	M16x1.5	C8UNPMB6M16	9.5	22	30	20	13	23	0.062
8	M22x1.5	C8UNPMB6M22	9.5	27	35	24	14	23	0.095
	M12x1.5	C8UNPMB8M12	9	17	25.5	17	11	22	0.039
	M14x1.5	C8UNPMB8M14	9.5	19	26.5	18	11	22	0.046
10	M16x1.5	C8UNPMB8M16	9.5	22	30	20	13	23	0.061
	M22x1.5	C8UNPMB8M22	9.5	27	35	24	14	23	0.092
	M16x1.5	C8UNPMB10M16	9.5	22	30.5	20.5	13	25	0.063
12	M22x1.5	C8UNPMB10M22	9.5	27	37	26	14	25	0.099
	M12x1.5	C8UNPMB12M12	9	17	32	21	14	25	0.063
	M16x1.5	C8UNPMB12M16	9.5	22	33	22	14	25	0.072
16	M22x1.5	C8UNPMB12M22	9.5	27	37	26	14	25	0.095
	M16x1.5	C8UNPMB16M16	9.5	22	37	23.5	24	34	0.170
	M22x1.5	C8UNPMB16M22	9.5	27	39	25.5	24	34	0.174

The body can be locked in the desired orientation with the locknut.

## V8UNPMB

### 45° Elbow, Male Metric Thread

Brass, NBR

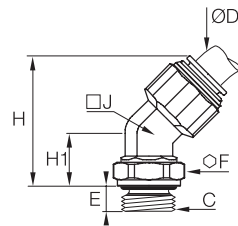

ØD	C		E	F	H	H1	J	Kg
8	M16x1.5	V8UNPMB8M16	9.5	22	38	17.5	14	0.063
10	M22x1.5	V8UNPMB10M22	9.5	27	44	21	14	0.085
12	M16x1.5	V8UNPMB12M16	9.5	22	44	17.5	14	0.074
	M22x1.5	V8UNPMB12M22	9.5	27	48	21	14	0.095
16	M22x1.5	V8UNPMB16M22	9.5	27	42	18	22	0.106

The body can be locked in the desired orientation with the locknut.

## S8UNPMB

### Stud Branch Tee, Male Metric Thread

Brass, NBR

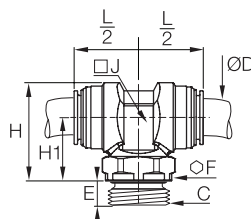

ØD	C		E	F	H	H1	J	L/2	Kg
8	M16x1.5	S8UNPMB8M16	9.5	22	39	27	14	24	0.097
	M22x1.5	S8UNPMB8M22	9.5	27	42	30.5	14	24	0.118
10	M16x1.5	S8UNPMB10M16	9.5	22	39	27	14	25.5	0.100
	M22x1.5	S8UNPMB10M22	9.5	27	42	30.5	14	25.5	0.118
12	M16x1.5	S8UNPMB12M16	9.5	22	39	27	14	27	0.110
	M22x1.5	S8UNPMB12M22	9.5	27	42	30.5	14	27	0.131
16	M22x1.5	S8UNPMB16M22	9.5	27	40	26	19	27	0.171

The body can be locked in the desired orientation with the locknut.

## S8UNPMBPPAM

### Stud Branch Tee, Male Metric Thread, In-Line Test Point

Brass, NBR

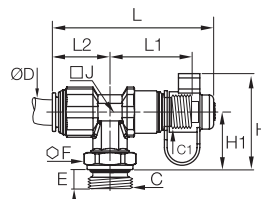

ØD	C	C1		E	F	H	H1	J	L	L1	L2	Kg
10	M16x1.5	M16x1.5	S8UNPMB10PPAM16	9.5	22	45	27	14	71	36	25	0.125
12	M16x1.5	M16x1.5	S8UNPMB12PPAM16	9.5	22	45	27	14	75	38	27	0.133
	M22x1.5	M16x1.5	S8UNPMB12PPAM22	9.5	27	48.5	30.5	14	75	38	27	0.154

The body can be locked in the desired orientation with the locknut.

# Tube-to-Tube Fittings

## HNPMB

### Equal Connector

Brass, NBR

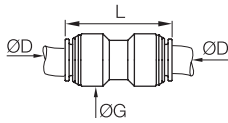

ØD		G	L	Kg
6	<a href="#">HNPMB6</a>	16	37.5	0.024
8	<a href="#">HNPMB8</a>	18	37	0.029
10	<a href="#">HNPMB10</a>	20	41	0.036
12	<a href="#">HNPMB12</a>	22	41	0.041
16	<a href="#">HNPMB16</a>	27	41	0.078

## WNPMB

### Equal Bulkhead Connector

Brass, NBR

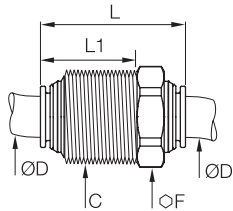

ØD	C		F	L	L1	Kg
6	M18x1.5	<a href="#">WNPMB6</a>	22	39.5	26	0.056
8	M20x1.5	<a href="#">WNPMB8</a>	22	39	26	0.061
10	M22x1.5	<a href="#">WNPMB10</a>	24	43	28	0.076
12	M24x1.5	<a href="#">WNPMB12</a>	27	44	29	0.091

## T2ENPMB

### Equal and Unequal 90° Plug-In Elbow

Brass, NBR

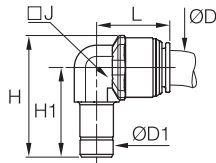

ØD	ØD1		H	H1	J	L	Kg
6	8	<a href="#">T2ENPMB6</a>	36	27.5	10	21	0.025
8	8	<a href="#">T2ENPMB8</a>	36	27.5	10	22	0.025
10	12	<a href="#">T2ENPMB10</a>	44	32.5	14	25.5	0.049
12	12	<a href="#">T2ENPMB12</a>	44	32.5	14	27	0.051

## JNPMB

### Equal and Unequal Tee

Brass, NBR

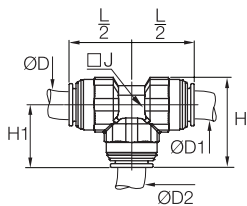

ØD	ØD1	ØD2		H	H1	J	L/2	Kg
6	6	6	<a href="#">JNPMB6</a>	30	22	12	22	0.044
8	8	8	<a href="#">JNPMB8</a>	31	23	12	23	0.050
		12	<a href="#">JNPMB8-8-12</a>	37	25	14	23	0.077
10	10	10	<a href="#">JNPMB10</a>	37	25.5	14	25.5	0.086
		6	<a href="#">JNPMB10-10-6</a>	36	24	14	23	0.073
		10	<a href="#">JNPMB10-6-10</a>	37	25.5	14	25.5	0.083
12	12	12	<a href="#">JNPMB12</a>	38	26.5	14	26.5	0.093
		6	<a href="#">JNPMB12-12-6</a>	35	24	14	26	0.086
		8	<a href="#">JNPMB12-12-8</a>	35	24	14	26	0.085
16	16	16	<a href="#">JNPMB16</a>	46	29	30	29	0.189



# Air Brake Adaptors

## D8C8UB

### 90° Elbow, Male/Female Metric Thread

Brass, NBR

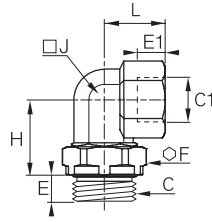

C	C1		E	E1	F	H	J	L	Kg
M16x1.5	M16x1.5	<a href="#">M16M16D8C8UB</a>	9.5	10	22	23.5	16	18.5	0.081
	M16x1.5	<a href="#">M16M22D8C8UB</a>	10.5	10	27	26.5	19	21.5	0.132
	M22x1.5	<a href="#">M22D8C8UB</a>	10.5	12	27	29.5	19	23.5	0.134

The body can be locked in the desired orientation with the locknut.

## D8V8UB

### 45° Elbow, Male/Female Metric Thread

Brass, NBR

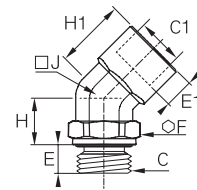

C	C1		E	E1	F	H	H1	J	Kg
M16x1.5	M16x1.5	<a href="#">M16M16D8V8UB</a>	9.5	10	22	15.5	22	17	0.077

The body can be locked in the desired orientation with the locknut.

## MR08UB

### Female Run Tee, Male Metric Thread

Laiton, NBR

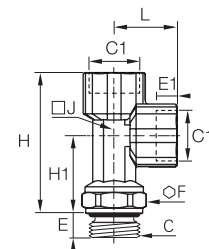

C	C1		E	E1	F	H	H1	J	L	Kg
M12x1.5	M12x1.5	<a href="#">M12MR08UB</a>	9	10	17	50.5	30	14	20.5	0.117
M16x1.5	M16x1.5	<a href="#">M16MR08UB</a>	10	10	22	62.5	39	14	23.5	0.134
	M16x1.5	<a href="#">M16M22M16MR08UB</a>	10.5	10	27	65	41.5	14	23.5	0.178
	M22x1.5	<a href="#">M22MR08UB</a>	10.5	12	27	69.5	41.5	18	28	0.222

The body can be locked in the desired orientation with the locknut.

## MMS8UB

### Branch Tee, Male/Female Metric Thread

Brass, NBR

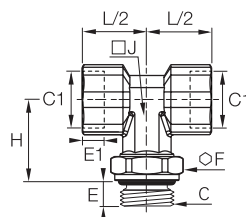

C	C1		E	E1	F	H	J	L/2	Kg
M12x1.5	M12x1.5	<a href="#">M12MMS8UB</a>	9	10	17	25.5	14	23.5	0.140
M16x1.5	M16x1.5	<a href="#">M16MMS8UB</a>	10	10	22	29	14	23.5	0.134
M22x1.5	M16x1.5	<a href="#">M16M16M22MMS8UB</a>	10.5	10	27	31	14	23.5	0.175

The body can be locked in the desired orientation with the locknut.

## MM08BKT

### Tee with Mounting Boss, Female Metric Thread

Brass, NBR

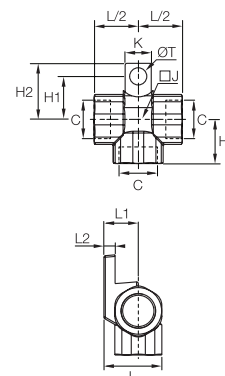

C		H	H1	H2	J	K	L	L1	L2	L/2	ØT	Kg
M16x1.5	<a href="#">M16MM08BKT</a>	20.5	26	20	19	12	27	16	5	20.5	8	0.112

# Air Brake Adaptors and Accessories

## F8UG8B

### Increaser, Male/Female Metric Thread

Brass, NBR

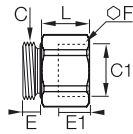

C	C1		E	E1	F	L	Kg
M12x1.5	M16x1.5	<a href="#">M12M16F8UG8B</a>	7.5	10	22	17.5	0.044

## F8UG8B

### Reducer, Male/Female Metric Thread

Brass, NBR

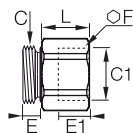

C	C1		E	E1	F	L	Kg
M16x1.5	M12x1.5	<a href="#">M16M12F8UG8B</a>	8	10	22	15	0.051
M22x1.5	M16x1.5	<a href="#">M22M16F8UG8B</a>	8	10	27	16	0.073

## F8UGB

### Conversion Fitting, Male Metric/Female NPT Thread

Brass, NBR

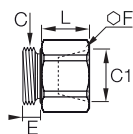

C	C1		E	F	L	Kg
M16x1.5	NPT1/4	<a href="#">M16-1/4F8UGB</a>	8	22	15	0.050
M22x1.5	NPT3/8	<a href="#">M22-3/8F8UGB</a>	8	27	18	0.080

## F8UG4B

### Conversion Fitting, Male Metric/Female BSPP Thread

Brass, NBR

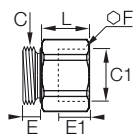

C	C1		E	E1	F	L	Kg
M16x1.5	G1/4	<a href="#">M16-1/4F8UG4B</a>	8	10	22	11.5	0.038
	G1/8	<a href="#">M16-1/8F8UG4B</a>	8	7	22	8	0.031

## F8UHA8UB

### Straight Male Adaptor, Male Metric Thread

Brass, NBR

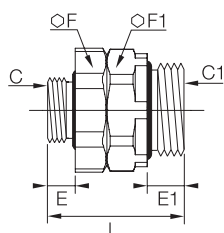

C	C1		E	E1	F	F1	L	Kg
M16x1.5	M16x1.5	<a href="#">M16F8UHA8UB</a>	8	10	22	22	32	0.056
	M22x1.5	<a href="#">M16M22F8UHA8UB</a>	8	10.5	27	27	36	0.096
M22x1.5	M22x1.5	<a href="#">M22F8UHA8UB</a>	8	10.5	27	27	36	0.096

# Air Brake Adaptors and Accessories

## WGG88B

### Bulkhead Union, Female Metric Thread

Brass, NBR

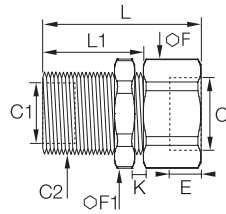

C	C1	C2		E	F	F1	K <sub>max</sub>	L	L1	Kg
M16x1.5	M16x1.5	M22x1.5	<a href="#">M16WGG88BH27</a>	10	27	27	16	30	23	0.082
M22x1.5	M16x1.5	M26x1.5	<a href="#">M22M16WGG88B</a>	12	30	32	10	32	18	0.128

## WG8F8UB

### Bulkhead Union, Male/Female Metric Thread

Brass, NBR

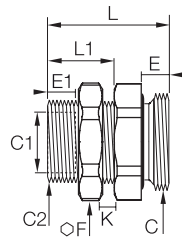

C	C1	C2		E	E1	F	K <sub>max</sub>	L	L1	Kg
M16x1.5	M16x1.5	M22x1.5	<a href="#">M16WG8F8UB</a>	8	10	27	10	32	17	0.086
M22x1.5	M16x1.5	M22x1.5	<a href="#">M16M22WG8F8UB</a>	8	10	27	10	32	17	0.080

## PPRF8UM

### Stud Test Point, Male Metric Thread

Brass, NBR

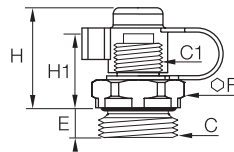

C	C1		E	F	H	H1	Kg
M16x1.5	M16x1.5	<a href="#">PPRF8UM16</a>	9.5	22	34.5	31.5	0.057
M22x1.5	M16x1.5	<a href="#">PPRF8UM22</a>	9.5	27	34.5	31.5	0.072

## PPRC8UM

### Test Point 90° Elbow, Male Metric Thread

Brass, NBR

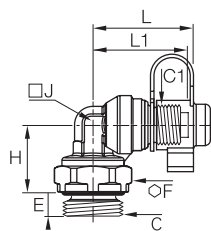

C	C1		E	F	H	J	L	L1	kg
M22x1.5	M16x1.5	<a href="#">PPRC8UM22</a>	10.5	27	18	19	39	36	0.142

The body can be locked in the desired orientation with the locknut.

## PPRV8UM

### Test Point 45° Elbow, Male Metric Thread

Brass, NBR

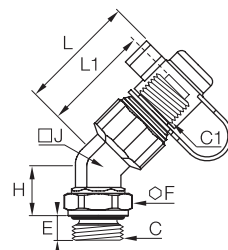

C	C1		E	F	H	J	L	L1	kg
M22x1.5	M16x1.5	<a href="#">PPRV8UM22</a>	10.5	27	32	14	38	35	0.119

The body can be locked in the desired orientation with the locknut.

# Air Brake Adaptors and Accessories

## VDPF8UM

### Drain Valve, Male Metric Thread

Brass, NBR

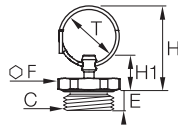

C		E	F	H	H1	ØT	Kg
M22x1.5	<a href="#">VDPF8UM22L13</a>	7.5	27	47.5	24	26	0.037

## P8UNBL

### Plug, Male Metric Thread

Brass, NBR

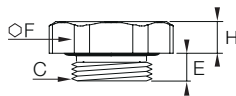

C		E	F	H	Kg
M12x1.5	<a href="#">M12P8UNBL</a>	7.5	17	4.5	0.013
M14x1.5	<a href="#">M14P8UNBL</a>	7.5	17	4.5	0.016
M16x1.5	<a href="#">M16P8UNBL</a>	8	22	5	0.022
M22x1.5	<a href="#">M22P8UNBL13</a>	7.5	27	5	0.038

## 3126

### Blanking Plug

Technical polymer

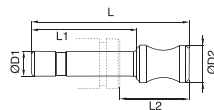

ØD		G	L	L1	Kg
6	<a href="#">3126 06 00</a>	8	33	16,5	0,001
8	<a href="#">3126 08 00</a>	10	35	17,5	0,001
10	<a href="#">3126 10 00</a>	12	42	21	0,002
12	<a href="#">3126 12 00</a>	14	45	22	0,003

## WLNB

### Bulkhead Locknut

Brass

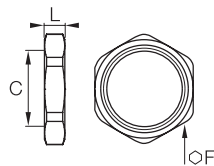

C		F	L	Kg
M16x1.5	<a href="#">WL8NBM16X1.5</a>	22	5	0.010
M18x1.5	<a href="#">WL8NBM18X1.5</a>	22	5	0.008
M20x1.5	<a href="#">WL8NBM20X1.5</a>	24	5	0.008
M22x1.5	<a href="#">WL8NBM22X1.5</a>	27	6	0.014
M24x1.5	<a href="#">WL8NBM24X1.5</a>	30	7	0.019



# LF 3600 Push-In Fittings Range

## Stud Fittings

### Straights

- 3675**  
BSPT  
Page 1-97
- 3601**  
BSPP/Metric  
Page 1-97
- 3681**  
Metric  
Page 1-97
- 3614**  
BSPP/Metric  
Page 1-98
- 3621**  
BSPT  
Page 1-98
- 3631**  
BSPP/Metric  
Page 1-98
- 3600**  
Page 1-98



### Elbows

- 3609**  
BSPT  
Page 1-99
- 3629**  
BSPT  
Page 1-99
- 3699**  
BSPP/Metric  
Page 1-99
- 3669**  
BSPP/Metric  
Page 1-100



### Tees

- 3608**  
BSPT  
Page 1-100
- 3603**  
BSPT  
Page 1-100
- 3698**  
BSPP/Metric  
Page 1-100
- 3693**  
BSPP/Metric  
Page 1-101



### Banjo

- 3618**  
BSPP/Metric  
Page 1-101



## Tube-to-Tube Fittings

### Straight

- 3606**  
Page 1-102



### Elbow

- 3602**  
Page 1-102



### Tee

- 3604**  
Page 1-102



## Bulkhead Connector Fittings

### Straights

- 3616**  
BSPT  
Page 1-103
- 3636**  
BSPP  
Page 1-103



### Elbow

- 3639**  
Page 1-103



## Plug-In Accessories

- 3666**  
Page 1-104
- 3667**  
Page 1-104
- 3668**  
Page 1-104
- 3622**  
Page 1-104
- 3620**  
Page 1-104
- 3626**  
Page 1-105



## Accessories

- 0605**  
Page 1-105
- 3000 70**  
Page 1-105
- 3610**  
Page 1-105



# LF 3600 Push-In Fittings

In order to meet your **technical and environment requirements**, Parker Legris designed this range of metal fittings, offering **robustness, reliability** and **resistance to industrial fluids** for the most demanding environments.

## Product Advantages

- High Performance**
  - Resistant up to +150°C at 30 bar
  - Excellent mechanical performance
  - Long threads to resist shock and vibration
  - Excellent abrasion and corrosion resistance due to high phosphorus chemical nickel plating
  - Full flow, minimal pressure drop
  
- Versatility**
  - Materials conform to FDA standards
  - Spring collet gripping system suitable for both metal (grooved) and polymer tubing
  - Excellent resistance to high pressure and vacuum
  - Excellent chemical compatibility
  - More than 250 part numbers
  - One fitting for numerous applications: stock optimisation
  - Manual connection and disconnection
  - Compact and ergonomic
  
- Reliability**
  - High performance brass for increased lifespan
  - 100% leak-tested in production
  - Date coding to guarantee quality and traceability



Food Process  
Coffee Machines  
In-Plant Automotive  
Medical Equipment  
Printing  
Misting  
Welding Robots

Applications

## Technical Characteristics

<b>Suitable Fluids</b>	Compressed air, grease, lubricant, water...
<b>Working Pressure</b>	Vacuum to 30 bar (20 bar: 3699, 3609)
<b>Working Temperature</b>	-25°C to +150°C

Maximum Tightening Torque (daN.m)	Thread							
	M5 x0.8	M6 x1	M8 x1	M10 x1	G1/8	G1/4	G3/8	G1/2
	0.16	0.18	0.6	0.8	0.8	1.2	3	3.5

Reliable performance is dependent upon the type of fluid conveyed, component materials and tubing being used.  
Use is guaranteed with a vacuum of 755 mm Hg (99% vacuum).

### Component Materials

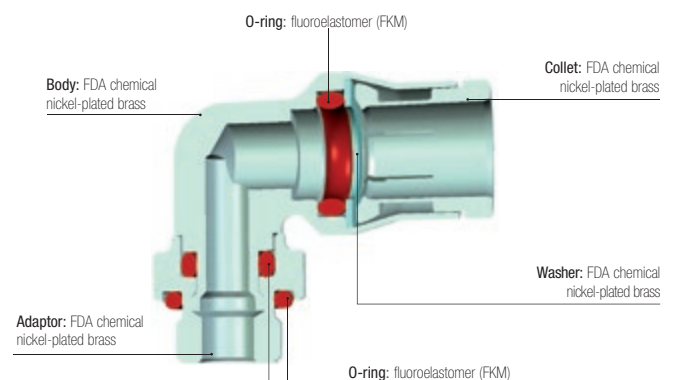

### Silicone-free

### Regulations

**Industrial**  
**ISO 14743:** pneumatic transmissions, push-in fittings for thermoplastic tubing  
**DI:** 97/23/EC (PED)  
**DI:** 2002/95/EC (RoHS), 2011/65/EC  
**RG:** 1907/2006 (REACH)  
**DI:** 94/9/EC (ATEX)  
**UL94 V-0:** please consult us

**Food**  
**RG:** 21CFR (FDA)  
**RG:** 1935/2004/EC (minimum flow 0.02 l/h)  
**USDA NSF H1:** grease  
**ASTM B733-04:** autocatalytic (electroless) nickel-phosphorus coatings



# Stud Fittings

## 3675 Stud Fitting, Male BSPT Thread



FDA chemical nickel-plated brass, FKM

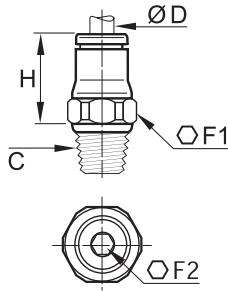

ØD	C		F1	F2	H	kg
4	R1/8	<a href="#">3675 04 10</a>	10	3	15	0.009
	R1/4	<a href="#">3675 04 13</a>	14	3	15	0.017
6	R1/8	<a href="#">3675 06 10</a>	13	4	17	0.011
	R1/4	<a href="#">3675 06 13</a>	14	4	17	0.018
8	R1/8	<a href="#">3675 08 10</a>	15	5	19	0.015
	R1/4	<a href="#">3675 08 13</a>	16	6	18	0.019
10	R3/8	<a href="#">3675 08 17</a>	17	6	18.5	0.027
	R1/4	<a href="#">3675 10 13</a>	18	7	23	0.026
	R3/8	<a href="#">3675 10 17</a>	18	8	22.5	0.031
	R1/2	<a href="#">3675 10 21</a>	22	8	22.5	0.056
12	R1/4	<a href="#">3675 12 13</a>	20	7	25.5	0.033
	R3/8	<a href="#">3675 12 17</a>	20	9	24	0.035
14	R1/2	<a href="#">3675 12 21</a>	22	10	23	0.051
	R3/8	<a href="#">3675 14 17</a>	22	9	27	0.042
	R1/2	<a href="#">3675 14 21</a>	24	11	26	0.057

## 3601 Stud Fitting, Male BSPP and Metric Thread



FDA chemical nickel-plated brass, FKM

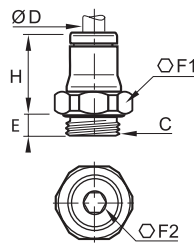

ØD	C		E	F1	F2	H	kg
4	M5x0.8	<a href="#">3601 04 19</a>	3.5	10	2.5	15.5	0.006
	M6x1	<a href="#">3601 04 52</a>	4.5	10	3	16	0.006
	M8x1	<a href="#">3601 04 56</a>	5	11	3	14.5	0.007
	G1/8	<a href="#">3601 04 10</a>	5.5	13	3	14.5	0.009
6	G1/4	<a href="#">3601 04 13</a>	6.5	16	3	14.5	0.015
	M5x0.8	<a href="#">3601 06 19</a>	3.5	13	2.5	19	0.010
	M10x1	<a href="#">3601 06 60</a>	5.5	13	4	17.5	0.011
	G1/8	<a href="#">3601 06 10</a>	5.5	13	4	17.5	0.011
8	G1/4	<a href="#">3601 06 13</a>	6.5	16	4	17	0.015
	G1/8	<a href="#">3601 08 10</a>	5.5	16	5	21	0.014
	G1/4	<a href="#">3601 08 13</a>	6.5	16	6	18	0.016
	G3/8	<a href="#">3601 08 17</a>	7.5	20	6	19	0.028
10	G1/4	<a href="#">3601 10 13</a>	6.5	18	7	25	0.025
	G3/8	<a href="#">3601 10 17</a>	7.5	20	8	22.5	0.028
	G1/2	<a href="#">3601 10 21</a>	9	24	8	22.5	0.043
	G1/4	<a href="#">3601 12 13</a>	6.5	20	7	26.5	0.030
12	G3/8	<a href="#">3601 12 17</a>	7.5	20	9	26	0.034
	G1/2	<a href="#">3601 12 21</a>	9	24	10	23.5	0.042
14	G3/8	<a href="#">3601 14 17</a>	7.5	22	9	28	0.038
	G1/2	<a href="#">3601 14 21</a>	9	24	11	26.5	0.045

## 3681 Stud Fitting with Internal Hexagon, Male Metric Thread



FDA chemical nickel-plated brass, FKM

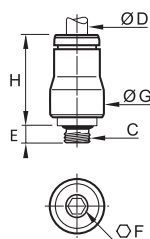

ØD	C		E	F	G	H	kg
4	M5x0.8	<a href="#">3681 04 19</a>	3.5	2.5	10	16	0.005

### Related Products

- Polyurethane Tubing
- Polyamide Tubing
- Polyethylene Tubing
- Fluoropolymer Tubing
- Anti-Spark Tubing
- Fireproof PA Tubing
- Brass Flow Control Regulators

# Stud Fittings

## 3614 Stud Fitting, Female BSPP and Metric Thread



FDA chemical nickel-plated brass, FKM

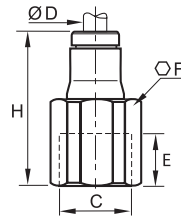

ØD	C		E	F	H	kg
4	M5x0.8	<a href="#">3614 04 19</a>	5	10	22	0.009
	G1/8	<a href="#">3614 04 10</a>	7.5	14	25	0.016
	G1/4	<a href="#">3614 04 13</a>	11	17	29	0.026
6	G1/8	<a href="#">3614 06 10</a>	7.5	14	27.5	0.019
	G1/4	<a href="#">3614 06 13</a>	11	17	31.5	0.028
8	G1/8	<a href="#">3614 08 10</a>	9.5	15	28.5	0.022
	G1/4	<a href="#">3614 08 13</a>	13.5	17	32.5	0.028
10	G3/8	<a href="#">3614 10 17</a>	14	22	38	0.052
12	G3/8	<a href="#">3614 12 17</a>	14	22	39	0.055
	G1/2	<a href="#">3614 12 21</a>	18.5	24	43.5	0.062

## 3621 Stud Standpipe, Male BSPT Thread



FDA chemical nickel-plated brass

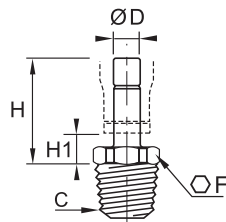

ØD	C		F	H	H1	kg
4	R1/8	<a href="#">3621 04 10</a>	10	21	7	0.006
	R1/4	<a href="#">3621 04 13</a>	14	21	7	0.014
6	R1/8	<a href="#">3621 06 10</a>	10	23.5	6.5	0.008
	R1/4	<a href="#">3621 06 13</a>	14	23.5	6.5	0.016
8	R1/8	<a href="#">3621 08 10</a>	10	24	6.5	0.009
	R1/4	<a href="#">3621 08 13</a>	14	24	6.5	0.017
10	R1/4	<a href="#">3621 10 13</a>	14	22	6.5	0.018
	R3/8	<a href="#">3621 10 17</a>	17	30	7.5	0.022
12	R3/8	<a href="#">3621 12 17</a>	17	31	7.5	0.023
	R1/2	<a href="#">3621 12 21</a>	22	31	7.5	0.041
14	R1/2	<a href="#">3621 14 21</a>	22	33	8	0.042

## 3631 Stud Standpipe, Male BSPP and Metric Thread



FDA chemical nickel-plated brass, FKM

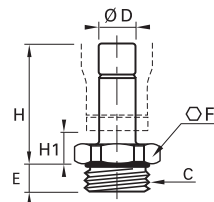

ØD	C		E	F	H	H1	kg
4	M5x0.8	<a href="#">3631 04 19</a>	3.5	13	21.5	7	0.003
	G1/8	<a href="#">3631 04 10</a>	5.5	13	20	7	0.007
	G1/4	<a href="#">3631 04 13</a>	6.5	8	20	7.5	0.011
6	G1/8	<a href="#">3631 06 10</a>	5.5	13	22.5	6.5	0.009
	G1/4	<a href="#">3631 06 13</a>	6.5	16	22.5	6.5	0.012
8	G1/8	<a href="#">3631 08 10</a>	5.5	13	22.5	6.5	0.010
	G1/4	<a href="#">3631 08 13</a>	6.5	16	23	6.5	0.013
	G3/8	<a href="#">3631 08 17</a>	7.5	20	23	7.5	0.018
10	G1/4	<a href="#">3631 10 13</a>	6.5	16	28	6.5	0.015
	G3/8	<a href="#">3631 10 17</a>	7.5	20	28	7.5	0.022
	G1/2	<a href="#">3631 10 21</a>	9	24	28	7.5	0.028
12	G3/8	<a href="#">3631 12 17</a>	7.5	20	29	7.5	0.023
	G1/2	<a href="#">3631 12 21</a>	9	24	29	7.5	0.033
14	G1/2	<a href="#">3631 14 21</a>	9	24	31	8	0.033

## 3600 One-Piece Cartridge



FDA chemical nickel-plated brass, FKM

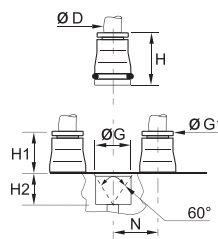

ØD		G	G1	H	H1	H2	N	kg
4	<a href="#">3600 04 00</a>	9.8	8	17	8.5	8.5	11	0.006
6	<a href="#">3600 06 00</a>	12.1	10	19	10.5	8.5	13.5	0.009
8	<a href="#">3600 08 00</a>	14.8	13	21	12.5	8.5	16	0.012
10	<a href="#">3600 10 00</a>	17.5	15	24.5	14	10.5	20	0.019
12	<a href="#">3600 12 00</a>	20	17	25	14.5	10.5	22.5	0.023
14	<a href="#">3600 14 00</a>	22	20	28.5	16.5	12	25	0.031

# Stud Fittings

## 3609 Stud Elbow, Male BSPT Thread



FDA chemical nickel-plated brass, FKM

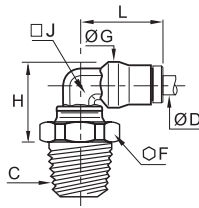

ØD	C		F	G	H	J	L	kg
4	R1/8	<a href="#">3609 04 10</a>	13	10	15	7	18	0.014
	R1/4	<a href="#">3609 04 13</a>	14	10	17	7	18	0.020
6	R1/8	<a href="#">3609 06 10</a>	13	12	17.5	8	21.5	0.018
	R1/4	<a href="#">3609 06 13</a>	14	12	19	8	21.5	0.025
8	R1/8	<a href="#">3609 08 10</a>	13	15	19.5	10	23.5	0.023
	R1/4	<a href="#">3609 08 13</a>	14	15	21	10	23.5	0.029
	R3/8	<a href="#">3609 08 17</a>	17	15	21	10	23.5	0.035
10	R1/4	<a href="#">3609 10 13</a>	15	17.5	23.5	12	29	0.037
	R3/8	<a href="#">3609 10 17</a>	17	17.5	25.5	12	29	0.043
12	R1/4	<a href="#">3609 12 13</a>	15	19.5	26	15	31	0.049
	R3/8	<a href="#">3609 12 17</a>	17	19.5	28.5	15	31	0.055
	R1/2	<a href="#">3609 12 21</a>	21	19.5	28.5	15	31	0.072
14	R3/8	<a href="#">3609 14 17</a>	19	21.5	29	16	34	0.063
	R1/2	<a href="#">3609 14 21</a>	22	21.5	30	16	34	0.072

The body swivels for positioning purposes.

## 3629 Extended Stud Elbow, Male BSPT Thread



FDA chemical nickel-plated brass, FKM

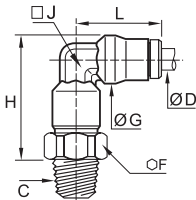

ØD	C		F	G	H	J	L	kg
4	R1/8	<a href="#">3629 04 10</a>	10	10	24.5	7	18	0.025
	R1/8	<a href="#">3629 06 10</a>	13	12	29.5	8	21.5	0.024
6	R1/4	<a href="#">3629 06 13</a>	14	12	30.5	8	21.5	0.031
	R1/8	<a href="#">3629 08 10</a>	14	15	32.5	10	23.5	0.031
8	R1/4	<a href="#">3629 08 13</a>	14	15	34	10	23.5	0.037
	R1/4	<a href="#">3629 10 13</a>	18	17.5	39	12	29	0.054

The body swivels for positioning purposes.

## 3699 Compact Elbow, Male BSPP and Metric Thread



FDA chemical nickel-plated brass, FKM

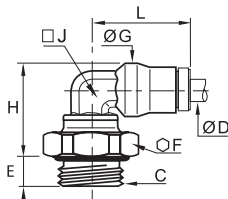

ØD	C		E	F	G	H	J	L	kg
4	M5x0.8	<a href="#">3699 04 19</a>	3.5	10	10	18	7	18	0.011
	M6x1	<a href="#">3699 04 52</a>	4.5	10	10	18	7	18	0.011
	M8x1	<a href="#">3699 04 56</a>	5	11	10	18	7	18	0.013
	G1/8	<a href="#">3699 04 10</a>	5.5	13	10	17	7	18	0.014
	G1/4	<a href="#">3699 04 13</a>	6.5	16	10	17.5	7	18	0.019
6	M10x1	<a href="#">3699 06 60</a>	5.5	13	12	19	8	21.5	0.017
	G1/8	<a href="#">3699 06 10</a>	5.5	13	12	19	8	21.5	0.018
	G1/4	<a href="#">3699 06 13</a>	6.5	16	12	19.5	8	21.5	0.022
8	G1/8	<a href="#">3699 08 10</a>	5.5	13	15	20.5	10	23.5	0.021
	G1/4	<a href="#">3699 08 13</a>	6.5	16	15	21.5	10	23.5	0.027
	G3/8	<a href="#">3699 08 17</a>	7.5	20	15	21.5	10	23.5	0.033
10	G1/4	<a href="#">3699 10 13</a>	6.5	16	17.5	27	12	29	0.037
	G3/8	<a href="#">3699 10 17</a>	7.5	20	17.5	25.5	12	29	0.043
12	G1/4	<a href="#">3699 12 13</a>	6.5	16	19.5	29.5	15	31	0.050
	G3/8	<a href="#">3699 12 17</a>	7.5	20	19.5	28.5	15	31	0.057
14	G1/2	<a href="#">3699 12 21</a>	9	24	19.5	28.5	15	31	0.065
	G3/8	<a href="#">3699 14 17</a>	7.5	20	21.5	29	16	34	0.059
	G1/2	<a href="#">3699 14 21</a>	9	24	21.5	29.5	16	34	0.062

The body swivels for positioning purposes.

# Stud Fittings

## 3669 Extended Stud Elbow, Male BSPP and Metric Thread



FDA chemical nickel-plated brass, FKM

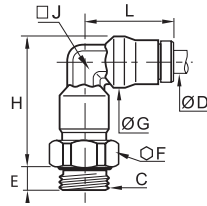

ØD	C		E	F	G	H	J	L	kg
4	M5x0.8	<a href="#">3669 04 19</a>	3.5	10	10	27.5	7	18	0.014
	G1/8	<a href="#">3669 04 10</a>	5.5	13	10	25.5	7	18	0.017
6	G1/8	<a href="#">3669 06 10</a>	5.5	13	12	31	8	21.5	0.024
	G1/4	<a href="#">3669 06 13</a>	6.5	16	12	30.5	8	21.5	0.028
8	G1/8	<a href="#">3669 08 10</a>	5.5	14	15	33.5	10	23.5	0.031
	G1/4	<a href="#">3669 08 13</a>	5.5	16	15	34	10	23.5	0.035
10	G1/4	<a href="#">3669 10 13</a>	6.5	18	17.5	42	12	29	0.052
	G3/8	<a href="#">3669 10 17</a>	7.5	20	17.5	41	12	29	0.056
12	G1/4	<a href="#">3669 12 13</a>	6.5	20	19.5	47	15	31	0.070
	G3/8	<a href="#">3669 12 17</a>	7.5	20	19.5	46	15	31	0.341
14	G1/2	<a href="#">3669 14 21</a>	9	24	21.5	49	16	34	0.094

The body swivels for positioning purposes.

## 3608 Stud Branch Tee, Male BSPT Thread



FDA chemical nickel-plated brass, FKM

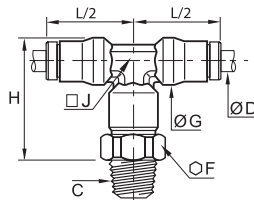

ØD	C		F	G	H	J	L/2	kg
4	R1/8	<a href="#">3608 04 10</a>	10	10	24.5	7	18	0.020
	R1/4	<a href="#">3608 06 13</a>	14	12	30.5	8	21.5	0.038
6	R1/8	<a href="#">3608 06 10</a>	13	12	29.5	8	21.5	0.031
	R1/4	<a href="#">3608 06 13</a>	14	12	30.5	8	21.5	0.038
8	R1/8	<a href="#">3608 08 10</a>	14	15	32.5	10	23.5	0.040
	R1/4	<a href="#">3608 08 13</a>	14	15	34	10	23.5	0.047
10	R1/4	<a href="#">3608 10 13</a>	18	17.5	39	12	29	0.067
	R3/8	<a href="#">3608 10 17</a>	18	17.5	41	12	29	0.070
12	R3/8	<a href="#">3608 12 17</a>	20	19.5	46.5	15	31	0.094
14	R1/2	<a href="#">3608 14 21</a>	22	21.5	50.5	16	34	0.125

The body swivels for positioning purposes.

## 3603 Stud Run Tee, Male BSPT Thread



FDA chemical nickel-plated brass, FKM

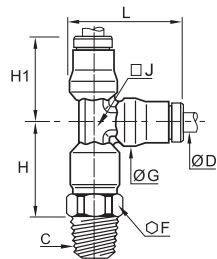

ØD	C		F	G	H	H1	J	L	kg
4	R1/8	<a href="#">3603 04 10</a>	10	10	19.5	18	7	23	0.018
	R1/4	<a href="#">3603 06 13</a>	14	12	24.5	21.5	8	28	0.037
6	R1/8	<a href="#">3603 06 10</a>	13	12	23.5	21.5	8	28	0.031
	R1/4	<a href="#">3603 06 13</a>	14	12	24.5	21.5	8	28	0.037
8	R1/8	<a href="#">3603 08 10</a>	14	15	25	23.5	10	31	0.041
	R1/4	<a href="#">3603 08 13</a>	14	15	26.5	23.5	10	31	0.044
10	R1/4	<a href="#">3603 10 13</a>	18	17.5	30.5	29	12	37.5	0.067
	R3/8	<a href="#">3603 10 17</a>	18	17.5	32.5	29	12	37.5	0.069
12	R3/8	<a href="#">3603 12 17</a>	20	19.5	36.5	31	15	40.5	0.103
14	R1/2	<a href="#">3603 14 21</a>	22	21.5	40	34	16	45	0.147

The body swivels for positioning purposes.

## 3698 Stud Branch Tee, Male BSPP and Metric Thread



FDA chemical nickel-plated brass, FKM

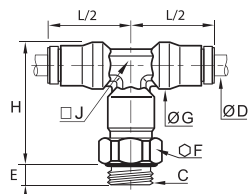

ØD	C		E	F	G	H	J	L/2	kg
4	M5x0.8	<a href="#">3698 04 19</a>	3.5	10	10	27.5	7	18	0.018
	G1/8	<a href="#">3698 04 10</a>	5.5	13	10	25.5	7	18	0.021
6	G1/8	<a href="#">3698 06 10</a>	5.5	13	12	31	8	21.5	0.031
	G1/4	<a href="#">3698 06 13</a>	6.5	16	12	30.5	8	21.5	0.035
8	G1/8	<a href="#">3698 08 10</a>	5.5	14	15	33.5	10	23.5	0.041
	G1/4	<a href="#">3698 08 13</a>	6.5	16	15	34	10	23.5	0.045
10	G1/4	<a href="#">3698 10 13</a>	6.5	18	17.5	42	12	29	0.066
12	G3/8	<a href="#">3698 12 17</a>	7.5	20	19.5	46	15	31	0.088
14	G1/2	<a href="#">3698 14 21</a>	9	24	21.5	49	16	34	0.111

The body swivels for positioning purposes.

# Stud Fittings

## 3693 Stud Run Tee, Male BSPP and Metric Thread



FDA chemical nickel-plated brass, FKM

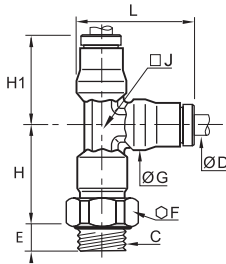

ØD	C		E	F	G	H	H1	J	L	kg
4	M5x0.8	<a href="#">3693 04 19</a>	3.5	10	10	22.5	18	7	23	0.019
	G1/8	<a href="#">3693 04 10</a>	5.5	13	10	20.5	18	7	23	0.021
6	G1/8	<a href="#">3693 06 10</a>	5.5	13	12	25	21.5	8	28	0.031
	G1/4	<a href="#">3693 06 13</a>	6.5	16	12	24.5	21.5	8	28	0.035
8	G1/8	<a href="#">3693 08 10</a>	5.5	14	15	26.5	23.5	10	31	0.041
	G1/4	<a href="#">3693 08 13</a>	6.5	16	15	26.5	23.5	10	31	0.044
10	G1/4	<a href="#">3693 10 13</a>	6.5	18	17.5	33	29	12	37.5	0.066
12	G3/8	<a href="#">3693 12 17</a>	7.5	20	19.5	36.5	31	15	40.5	0.090
14	G1/2	<a href="#">3693 14 21</a>	9	24	21.5	38.5	34	16	45	0.112

The body swivels for positioning purposes.

## 3618 Single Banjo, Male BSPP and Metric Thread



FKM, FDA chemical nickel-plated brass

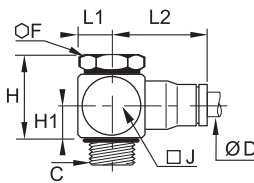

ØD	C		F	H	H1	J	L1	L2	kg
4	M5x0.8	<a href="#">3618 04 19</a>	8	14.5	6.5	10	6	18.5	0.011
	G1/8	<a href="#">3618 04 10</a>	14	23	9.5	17	10	20.5	0.029
6	M5x0.8	<a href="#">3618 06 19</a>	8	15	7	10	6	22.5	0.015
	G1/8	<a href="#">3618 06 10</a>	14	23	9.5	17	10	23.5	0.031
8	G1/4	<a href="#">3618 06 13</a>	17	22	9	22	13	25.5	0.049
	G1/8	<a href="#">3618 08 10</a>	14	23	9.5	17	10	26	0.033
10	G1/4	<a href="#">3618 08 13</a>	17	22	9	22	13	27.5	0.051
	G3/8	<a href="#">3618 10 17</a>	22	33	14	22	13	32	0.105

Maximum temperature: +80°C

Each model has been designed to meet specific requirements: compactness due to small overall dimensions, with inter-connectability for customised configurations.



# Tube-to-Tube Fittings

## 3606 Equal Tube-to-Tube Connector



FDA chemical nickel-plated brass, FKM

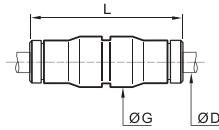

ØD		G	L	kg
4	<a href="#">3606 04 00</a>	10	30.5	0.010
6	<a href="#">3606 06 00</a>	12	36.5	0.016
8	<a href="#">3606 08 00</a>	15	37.5	0.021
10	<a href="#">3606 10 00</a>	17.5	47.5	0.034
12	<a href="#">3606 12 00</a>	19.5	50	0.042
14	<a href="#">3606 14 00</a>	21.5	52.5	0.050

## 3602 Equal Elbow



FDA chemical nickel-plated brass, FKM

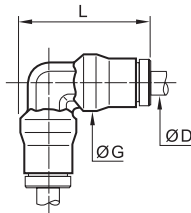

ØD		G	L	kg
4	<a href="#">3602 04 00</a>	10	23	0.010
6	<a href="#">3602 06 00</a>	12	28	0.016
8	<a href="#">3602 08 00</a>	15	31	0.023
10	<a href="#">3602 10 00</a>	17.5	37.5	0.033
12	<a href="#">3602 12 00</a>	19.5	40.5	0.045
14	<a href="#">3602 14 00</a>	21.5	45	0.056

## 3604 Equal Tee



FDA chemical nickel-plated brass, FKM

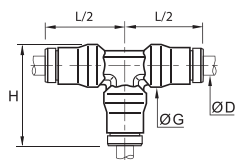

ØD		G	H	L/2	kg
4	<a href="#">3604 04 00</a>	10	23	18	0.014
6	<a href="#">3604 06 00</a>	12	28	21.5	0.023
8	<a href="#">3604 08 00</a>	15	31	23.5	0.032
10	<a href="#">3604 10 00</a>	17.5	37.5	29	0.048
12	<a href="#">3604 12 00</a>	19.5	40.5	31	0.063
14	<a href="#">3604 14 00</a>	21.5	45	34	0.078

# Bulkhead Connector Fittings

## 3616 Equal Bulkhead Connector



FDA chemical nickel-plated brass, FKM

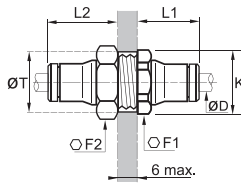

ØD		F1	F2	K	L1	L2	ØT min	kg
4	<a href="#">3616 04 00</a>	13	14	14	14	20	12.5	0.018
6	<a href="#">3616 06 00</a>	16	17	17.5	17	22	15	0.028
8	<a href="#">3616 08 00</a>	18	19	19.5	18.5	23.5	17	0.036
10	<a href="#">3616 10 00</a>	22	27	24	21.5	26.5	21	0.063
12	<a href="#">3616 12 00</a>	24	24	26	23	27	23	0.062
14	<a href="#">3616 14 00</a>	27	27	29.5	25.5	29.5	25	0.079

## 3636 Bulkhead Connector, Female BSPP Thread



FDA chemical nickel-plated brass, FKM

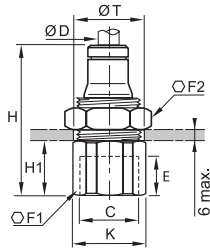

ØD	C		E	F1	F2	H	H1	K	ØT min	kg
4	G1/8	<a href="#">3636 04 10</a>	8.5	14	14	30.5	11	15	13	0.020
	G1/8	<a href="#">3636 06 10</a>	8.5	17	17	33	11	18.5	15	0.033
6	G1/4	<a href="#">3636 06 13</a>	11.5	17	17	37	15	18.5	15	0.033
	G1/8	<a href="#">3636 08 10</a>	8.5	19	19	34	10.5	21	17	0.044
8	G1/4	<a href="#">3636 08 13</a>	11.5	19	19	38	14.5	21	17	0.044
	G3/8	<a href="#">3636 10 17</a>	12	22	27	42.5	16	24	21	0.073
10	G3/8	<a href="#">3636 12 17</a>	12	24	24	43	16	26	23	0.077
	G1/2	<a href="#">3636 12 21</a>	16	27	24	48.5	21.5	29.5	23	0.133

## 3639 Equal Bulkhead Elbow



FDA chemical nickel-plated brass, FKM

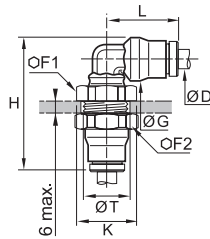

ØD		F1	F2	G	H	K	L	ØT min	kg
4	<a href="#">3639 04 00</a>	13	14	10	35	14	18	12.5	0.023
6	<a href="#">3639 06 00</a>	16	17	12	40.5	17.5	21.5	15	0.035
8	<a href="#">3639 08 00</a>	18	19	15	44	19.5	23.5	17	0.046
10	<a href="#">3639 10 00</a>	22	27	17.5	51	24	29	21	0.080
12	<a href="#">3639 12 00</a>	24	24	19.5	55	26	31	23	0.086
14	<a href="#">3639 14 00</a>	27	27	21.5	59	29.5	34	25	0.144

The body swivels for positioning purposes.



# Plug-In Accessories

## 3666 Plug-In Reducer



FDA chemical nickel-plated brass, FKM

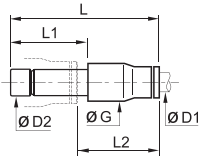

ØD1	ØD2		G	L	L1	L2	kg
4	6	<a href="#">3666 04 06</a>	10	35	19.5	18	0.008
	8	<a href="#">3666 04 08</a>	10	35.5	20	18	0.009
6	8	<a href="#">3666 06 08</a>	12	38	20	20.5	0.012
	10	<a href="#">3666 06 10</a>	12	43.5	25	21	0.015
8	10	<a href="#">3666 08 10</a>	15	44	25	21.5	0.016
	12	<a href="#">3666 08 12</a>	15	44	26	20.5	0.018
10	12	<a href="#">3666 10 12</a>	17.5	50	26	27	0.026
12	14	<a href="#">3666 12 14</a>	19.5	53	28	28.5	0.032

## 3667 Plug-In Metric/Inch Adaptor



FDA chemical nickel-plated brass, FKM

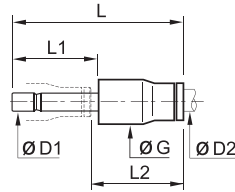

ØD1	ØD2		G	L	L1	L2	kg
6	1/4	<a href="#">3667 06 56</a>	12.5	38.5	19.5	21	0.012
10	3/8	<a href="#">3667 10 60</a>	17	49.5	25	27	0.026
12	1/2	<a href="#">3667 12 62</a>	20	51	26	27.5	0.030

## 3668 Plug-In Increaser



FDA chemical nickel-plated brass, FKM

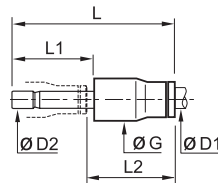

ØD1	ØD2		G	L	L1	L2	kg
6	4	<a href="#">3668 06 04</a>	12	36	17	21.5	0.010

## 3622 Plug-In Barb Connector



FDA chemical nickel-plated brass

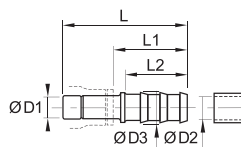

ØD1	ØD2		ØD3	L	L1	L2	kg
4	3.2	<a href="#">3622 04 53</a>	5	40.5	27	22.5	0.003
	5	<a href="#">3622 04 05</a>	7	40.5	27	22.5	0.005
6	5	<a href="#">3622 06 05</a>	7	43	27	22.5	0.006
	6.3	<a href="#">3622 08 56</a>	8.3	42	25	22.5	0.008
8	8	<a href="#">3622 08 08</a>	10	44	27	22.5	0.010
	6.3	<a href="#">3622 10 56</a>	8.3	47.5	25.5	22.5	0.011
10	8	<a href="#">3622 10 08</a>	10	47.5	25.5	22.5	0.011
	8	<a href="#">3622 12 08</a>	10	48.5	25.5	22.5	0.015
12	10	<a href="#">3622 12 10</a>	10	48.5	25.5	22.5	0.014
	12.5	<a href="#">3622 12 62</a>	14.5	57	34	29.5	0.019
14	12.5	<a href="#">3622 14 62</a>	16	57.5	33	29.5	0.022
	14	<a href="#">3622 14 14</a>	16	59.5	35	29.5	0.023

## 3620 Male Stem Connector



FDA chemical nickel-plated brass

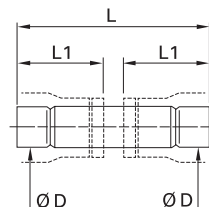

ØD		L	L1	kg
4	<a href="#">3620 04 00</a>	31	14	0.002
6	<a href="#">3620 06 00</a>	36.5	17	0.005
8	<a href="#">3620 08 00</a>	37.5	17.5	0.007
10	<a href="#">3620 10 00</a>	47.5	22.5	0.011
12	<a href="#">3620 12 00</a>	49.5	23.5	0.015
14	<a href="#">3620 14 00</a>	53	25	0.016

# Accessories

## 3626 Blanking Plug



FDA chemical nickel-plated brass

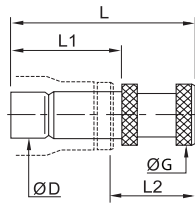

ØD		G	L	L1	L2	kg
4	<a href="#">3626 04 00</a>	6	25.5	17.5	11.5	0.004
6	<a href="#">3626 06 00</a>	8	30.5	19.5	13.5	0.009
8	<a href="#">3626 08 00</a>	10	33	20	16	0.009
10	<a href="#">3626 10 00</a>	12	40	25	18	0.015
12	<a href="#">3626 12 00</a>	14	43	26	20	0.021
14	<a href="#">3626 14 00</a>	16	47	28	22.5	0.029

## 0605 Fluoropolymer Tape

FKM



kg



[0605 12 12](#)

0.012

Can be used for temperatures from - 250°C to +260°C.

Chemically inert and resistant to gases, acids, solvents, hydrocarbons, oils, alkalines, steam etc.

Non-toxic, waterproof, self-lubricating.

In accordance with CFR21.

Can be used on all materials.

Used to facilitate the preparation of leak-free threaded joints.

Supplied on a reel, length = 12 m, width = 12.7 mm, thickness 0.08 mm.

## 3000 70 Dismounting Tool

Treated steel



H H1 L kg

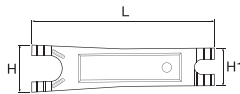

[3000 70 00](#)

25 20 96 0.021

For dismounting LF 3000® tubing/fittings where access is difficult, we recommend the use of this dismounting tool.

## 3610 Coloured Release Button Covers

Anodised aluminium

ØD



kg



6	<a href="#">3610 06 00</a>	<a href="#">3610 06 04</a>	0.004
8	<a href="#">3610 08 00</a>	<a href="#">3610 08 04</a>	0.007
10	<a href="#">3610 10 00</a>	<a href="#">3610 10 04</a>	0.011
12	<a href="#">3610 12 00</a>	<a href="#">3610 12 04</a>	0.013
14	<a href="#">3610 14 00</a>	<a href="#">3610 14 04</a>	0.016

Red and green colours are available upon request.

Coloured release buttons covers help the identification of circuits and will protect your connections against spark projections.



# LF 6100 Push-In Fittings Range

## Stud Fittings

### Straights

**6105**  
BSPT/Metric Taper  
Page 1-109

**6101**  
Metric Parallel  
Page 1-109

**6114**  
Metric Parallel  
Page 1-109



### Elbow

**6179**  
BSPT Metric Taper  
Page 1-109



## Tube-to-Tube Fittings

### Straight

**6106**  
Page 1-110



### Tee

**6104**  
Page 110



## Accessory

**0138**  
Page 1-110



# LF 6100 Push-In Fittings

This fittings range dedicated to **lubrication and vacuum systems**, combines very high performance and manual connection. This technology **secures the connection** and sealing performance, even at high pressure.

## Product Advantages

**Robust** | Designed for mechanically demanding environments  
Excellent pressure and temperature resistance  
Stamped brass forgings for increased service life

**Secure & Reliable** | Perfect sealing guaranteed by the three rings  
The two sealing O-rings positioned before the gripping ring endure no scratching on the tube in the sealing area  
Manual connection for time-saving  
No fluid loss  
Tube cannot be disconnected without the use of a spanner  
Up to 60 bar with rigid polymer or grooved metal tubing  
100% leak-tested in production



Construction Equipment  
Lubrication  
Transportation  
Measurement Systems  
Industrial Machines  
Industrial Vacuum

Applications

## Technical Characteristics

<b>Compatible Fluids</b>	Lubricants, compressed air, vacuum, other fluids and compatible gases
<b>Working Pressure</b>	Vacuum to 60 bar
<b>Working Temperature</b>	-40° to +120°C

<b>Max./Min. Tightening Torques (daN.m)</b>	<b>Thread</b>	M6 x1	M8 x1	M8 x1.25	M10 x1	M12 x1	M14 x1.5	R 1/8	R 1/4
	<b>Taper</b>	0.2/0.6	0.2/1.2	0.2/1	0.2/1.2	0.2/2	0.5/1.5	0.2/1.0	0.5/1.5
	<b>Parallel</b>	-	0.6/1	-	0.6/1	1.8/2.2	-	-	-

Reliable performance is dependent upon the type of fluid conveyed, component materials and tubing being used.  
Use is guaranteed with a vacuum of 755 mm Hg (99% vacuum).

### Component Materials

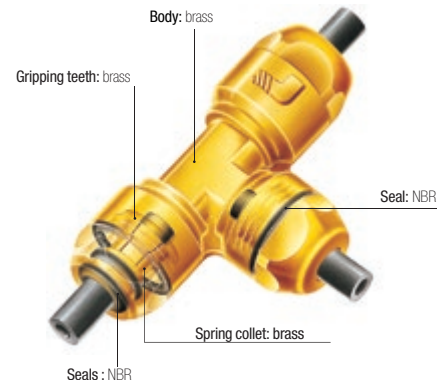

Silicone-free

### Regulations

DI: 97/23/EC (PED)  
DI: 2002/95/EC (RoHS),  
2011/65/EC

DI: 94/9/EC (ATEX)  
RG: 1907/2006 (REACH)

### Performance

#### Working Pressure/Temperature According to the Tubing Used

O.D. of Tube	-20°C to +20°C		+20°C to +30°C		+30°C to +50°C		+50°C to +80°C		+80°C to +120°C
	Semi-Rigid PA	Rigid PA	Semi-Rigid PA	Rigid PA	Semi-Rigid PA	Rigid PA	Semi-Rigid PA	Rigid PA	FEP
2x4	40	-	33	-	25.5	-	19	-	-
2.5x4	-	52	-	43	-	32	-	24.5	7
2.7x4	23	-	19	-	15	-	11	-	-
4x6	24	45	20	37	15.5	29	11	21	6
5x8	-	52	-	43	-	33	-	24	-
6x8	17	32	14	27	11	21	8	15	4
6x10	-	57	-	47	-	37	-	27	-
7.5x10	17	-	14	-	11	-	8	-	-
8x10	14	-	12	-	9	-	7	-	3

# Stud Fittings

## 6105 Stud Fitting, Male BSPT and Taper Metric Thread

Brass, NBR

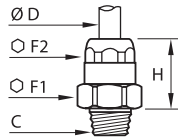

ØD	C		F1	F2	H	kg
4	M6x1	<a href="#">6105 04 52</a>	13	11	16.5	0.013
	M8x1	<a href="#">6105 04 56</a>	13	11	14.5	0.012
	M8x1.25	<a href="#">6105 04 57</a>	13	11	14.5	0.012
	M10x1	<a href="#">6105 04 60</a>	13	11	14.5	0.014
	R1/8	<a href="#">6105 04 10</a>	13	11	14.5	0.014
6	R1/4	<a href="#">6105 04 13</a>	14	11	12.5	0.018
	M10x1	<a href="#">6105 06 60</a>	17	14	16.5	0.024
	R1/8	<a href="#">6105 06 10</a>	17	14	17.5	0.026
8	M14x1.5	<a href="#">6105 06 71</a>	17	14	16.5	0.029
	R1/4	<a href="#">6105 06 13</a>	17	14	16.5	0.029
8	M12x1	<a href="#">6105 08 65</a>	19	21	24	0.041
10	M14x1.5	<a href="#">6105 10 71</a>	22	24	26	0.005

## 6101 Stud Fitting, Male Parallel and Metric Thread

Brass, NBR

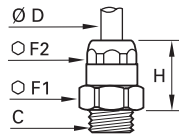

ØD	C		F1	F2	H	kg
4	M10x1	<a href="#">6101 04 60</a>	13	11	14	0.014
6	M10x1	<a href="#">6101 06 60</a>	17	14	17.5	0.026
	M12x1	<a href="#">6101 06 65</a>	17	14	16.5	0.025

## 6114 Stud Fitting, Female Metric Parallel Thread

Brass, NBR

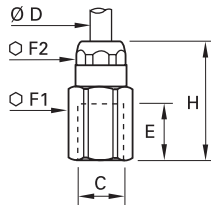

ØD	C		E	F1	F2	H	kg
4	M8x1	<a href="#">6114 04 56</a>	8	13	11	25.5	0.021
6	M8x1	<a href="#">6114 06 56</a>	8	17	14	28.5	0.043

## 6179 Stud Elbow, Male BSPT and Taper Metric Thread

Brass, NBR

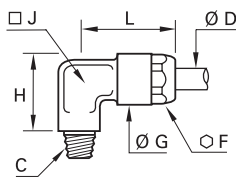

ØD	C		F	G	H	J	L	kg
4	M6x1	<a href="#">6179 04 52</a>	11	12.5	14.5	6	20	0.014
	M8x1	<a href="#">6179 04 56</a>	11	12.5	15	6	20	0.015
	M8x1.25	<a href="#">6179 04 57</a>	11	12.5	15	6	20	0.014
	M10x1	<a href="#">6179 04 60</a>	11	12.5	15.5	6	20	0.016
	R1/8	<a href="#">6179 04 10</a>	11	12.5	15.5	6	20	0.016
6	R1/4	<a href="#">6179 04 13</a>	11	12.5	17	6	20	0.023
	M10x1	<a href="#">6179 06 60</a>	14	16	18	8	25.5	0.029
	M12x1	<a href="#">6179 06 65</a>	14	16	18	8	25.5	0.030
8	R1/8	<a href="#">6179 06 10</a>	14	16	18	8	25.5	0.030
	R1/4	<a href="#">6179 06 13</a>	14	16	19	8	25.5	0.036
8	M12x1	<a href="#">6179 08 65</a>	17	19	21	10	30	0.047

# Tube-to-Tube Fittings

## 6106 Tube-to-Tube Connector

Brass, NBR

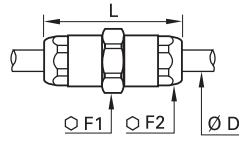

ØD		F1	F2	L	kg
4	<a href="#">6106 04 00</a>	13	11	34	0.025
6	<a href="#">6106 06 00</a>	17	14	39	0.044
8	<a href="#">6106 08 00</a>	19	17	46	0.069

## 6104 Equal Tee

Brass, NBR

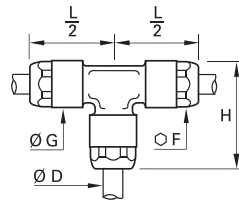

ØD		F	G	H	L/2	kg
4	<a href="#">6104 04 00</a>	11	12.5	26.5	20	0.032
6	<a href="#">6104 06 00</a>	14	16	32.5	25.5	0.066
8	<a href="#">6104 08 00</a>	17	19	38	30	0.103

## 0138 Copper Washer

Copper

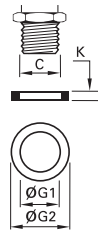

C		G1	G2	K	kg
M8	<a href="#">0138 08 00</a>	8.3	11	1	0.001
G1/8	<a href="#">0138 10 00</a>	10.3	13.5	1	0.001
M12	<a href="#">0138 12 00</a>	12.3	15.5	1.3	0.001

DIN 7603  
ISO 65061

### Related Products

The Parker Legris push-in system for centralised lubrication is designed for use with various polymer tubing found in Chapter 3, "Technical Tubing and Hose":

- Fireproof High Resistance Polyamide Tubing
- Rigid and Semi-Rigid Calibrated Polyamide Tubing
- Fluoropolymer Tubing





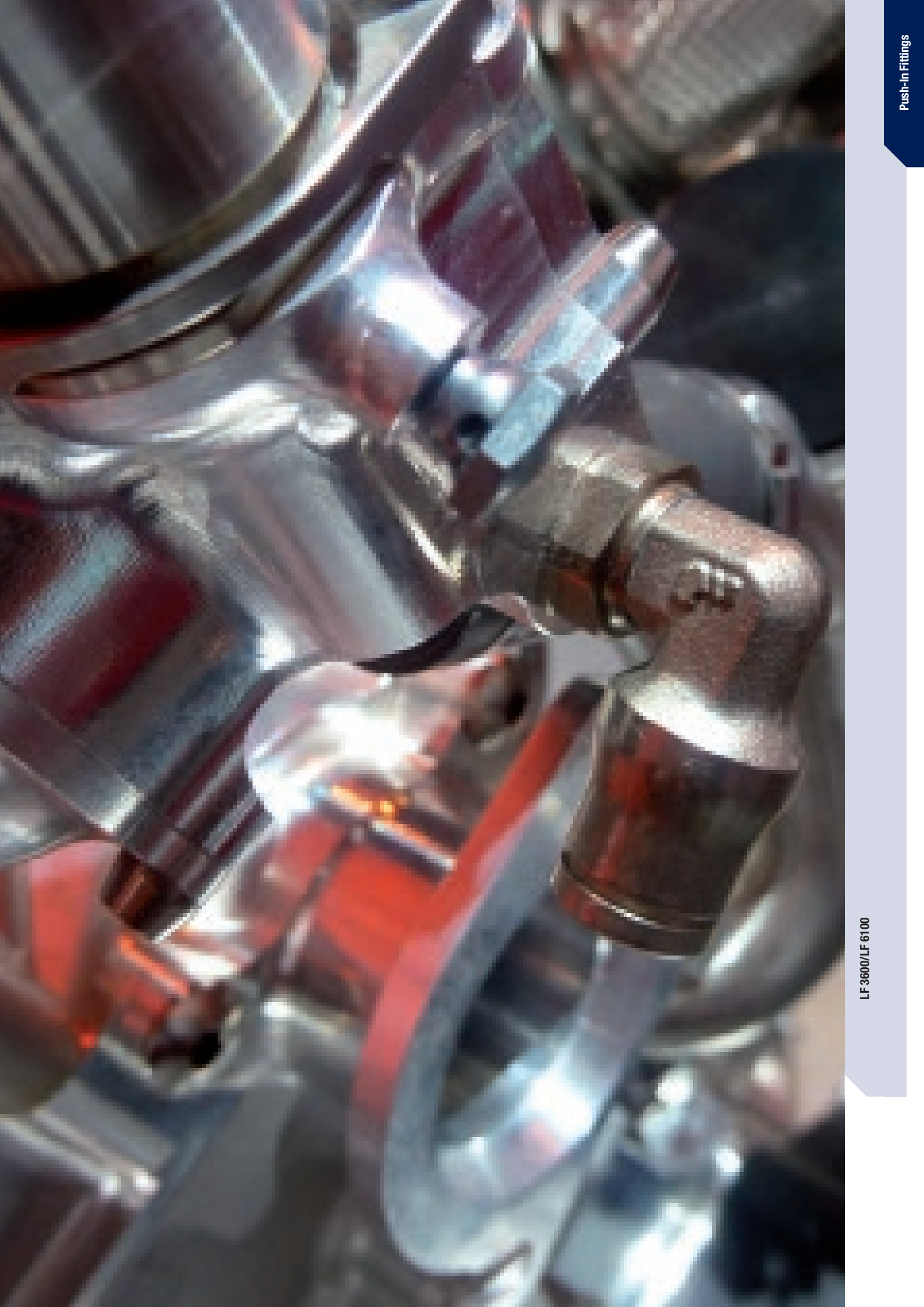

LF 3600/LF 6100

Push-In Fittings



# LF 3800/LF 3900 Push-In Fittings Range

## Stud Fittings

### Straights

**3805**  
**3905**  
BSPT  
Page 1-115



**3805**  
NPT  
Page 1-115



**3801**  
**3901**  
BSPP/Metric  
Page 1-115



**3821**  
**3921**  
BSPT  
Page 1-116



**3821**  
**3921**  
NPT  
Page 1-116



**3831**  
**3931**  
BSPP/Metric  
Page 1-116



**3800**  
**3900**  
Page 1-117



### Straights - Inch

**3805**  
NPT  
Page 1-115



**3821**  
NPT  
Page 1-116



### Elbows

**3809**  
**3909**  
BSPT  
Page 1-117



**3809**  
NPT  
Page 1-117



**3899**  
**3999**  
BSPP/Metric  
Page 1-117



**3889**  
**3989**  
BSPT  
Page 1-118



**3889**  
NPT  
Page 1-118



**3879**  
**3979**  
BSPP  
Page 1-118



**3889**  
NPT  
Page 1-118



### Elbow - Inch

### Tees

**3803**  
**3903**  
BSPT  
Page 1-119



**3803**  
NPT  
Page 1-119



**3893**  
**3993**  
BSPP/Metric  
Page 1-119



**3808**  
**3908**  
BSPT  
Page 1-119



**3808**  
NPT  
Page 1-120



**3898**  
**3998**  
BSPP/Metric  
Page 1-120



## Tube-to-Tube Fittings

### Straight

**3806**  
**3906**  
Page 1-121



### Straight - Inch

**3806**  
**3906**  
Page 1-121



### Elbow

**3802**  
**3902**  
Page 1-121



### Elbow - Inch

**3802**  
**3902**  
Page 1-121



### Tee

**3804**  
**3904**  
Page 1-121



### Tee - Inch

**3804**  
Page 1-122



## Bulkhead Connector Fittings

### Straight

**3816**  
**3916**  
Page 1-122



### Straight - Inch

**3816**  
**3916**  
Page 1-122



## Plug-In Fittings and Accessories

**3866**  
**3966**  
Reducer  
Page 1-123



**3826**  
Plug  
Page 1-123



## Accessories

**3800 70**  
Page 1-123



**0605**  
Page 1-123



**3000 70**  
Page 1-123



# LF 3800/LF 3900 Push-In Fittings

Parker Legris has developed two ranges of **stainless steel fittings (LF 3800 or LF 3900 in full 316L)** for conveying corrosive fluids in **aggressive environments**. These ranges provide two complementary levels of corrosion resistance and a **hygienic external design**.

## Product Advantages

### High Resistance to Aggressive Environments

LF 3800: excellent for conveying aggressive fluids  
 LF 3900: maximum chemical resistance to internal and external corrosion  
 Hygienic external design for reducing retention zones  
 Easy cleaning in situ  
 Proven gripping technology

### Wide Range of Applications

Perfect for permanent contact with foodstuffs  
 Compatible with frequent sterilization  
 Excellent in saline environments and outdoor applications  
 Resistant to industrial cleaning agents and detergents  
 Compatible with polymer and grooved stainless steel tubing  
 One fitting for many applications: optimised stock management

### Reliability & Safety

All-metal product allowing detection of all components  
 Full bore, with minimal pressure drop  
 Resistant to hammering, mechanical shock and impulse  
 Manual connection and disconnection, no tools required  
 100% leak-tested in production  
 Date coding to guarantee quality and traceability  
 IP 51 bulkhead: complete protection against ingress in food and non-food zones



**Applications**

Food Process  
 Paper Industry  
 Petrochemical  
 Pharmaceutical  
 Chemical  
 Medical

## Technical Characteristics

<b>Compatible Fluids</b>	All fluids compatible with the fitting and tubing component materials					
<b>Working Pressure</b>	Vacuum to 30 bar (20 bar: 3879/3979 and 3889/3989)					
<b>Working Temperature</b>	-25° to +150°C					

<b>Adaptor Tightening Torque</b>	Threads	M5x0.8	G1/8	G1/4	G3/8	G1/2
	daN.m	0.16	0.8	1.2	3	3.5
<b>Bulkhead Tightening Torque</b>	Ø (mm)	4	6	8	10	12
	daN.m min. max.	0.5 0.9	0.5 0.9	0.6 1	0.6 1	0.6 1

Reliable performance is dependent upon the type of fluid conveyed, component materials and tubing being used.  
 Use is guaranteed with a vacuum of 755 mm Hg (99% vacuum).  
 Technical performance tested at -25°C according to the ISO 14743 standard.

### Component Materials

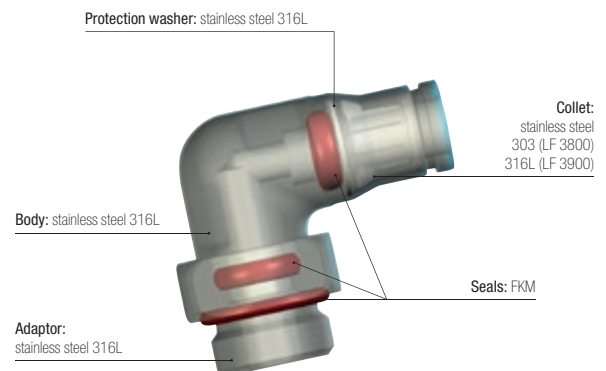

### Silicone-free

### Regulations

ISO 14743 Pneumatic transmissions, push-in fittings for thermoplastic tubing  
 EN 45545-2: HL3, R22, R24, R25 classification can be attained when used with fireproof tubing  
 DI: 97/23/EC (PED)  
 DI: 2002/95/EC (RoHS), 2011/65/EC

DI: 94/9/EC (ATEX)  
 RG : 1907/2006 (REACH)  
 UL94 V-0: Seal  
 RG: 21CFR (FDA)  
 RG: 1935/2004/EC  
 USDA NSF H1: Grease

# Stud Fittings

## 3805/3905 Stud Fitting, Male BSPT Thread



Stainless steel 316L, FKM

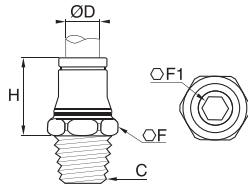

ØD	C			F	F1	H	Kg
4	R1/8	<a href="#">3805 04 10</a>	<a href="#">3905 04 10</a>	10	3	14.5	0.008
	R1/4	<a href="#">3805 04 13</a>	<a href="#">3905 04 13</a>	14	3	14.5	0.016
6	R1/8	<a href="#">3805 06 10</a>	<a href="#">3905 06 10</a>	13	4	18	0.012
	R1/4	<a href="#">3805 06 13</a>	<a href="#">3905 06 13</a>	14	4	16.5	0.018
8	R1/8	<a href="#">3805 08 10</a>	<a href="#">3905 08 10</a>	15	5	19	0.014
	R1/4	<a href="#">3805 08 13</a>	<a href="#">3905 08 13</a>	15	6	18	0.018
10	R3/8	<a href="#">3805 08 17</a>	<a href="#">3905 08 17</a>	17	6	18.5	0.025
	R1/4	<a href="#">3805 10 13</a>	<a href="#">3905 10 13</a>	19	6	24	0.029
	R3/8	<a href="#">3805 10 17</a>	<a href="#">3905 10 17</a>	19	6	22.5	0.030
	R1/4	<a href="#">3805 12 13</a>	<a href="#">3905 12 13</a>	22	7	25	0.034
12	R3/8	<a href="#">3805 12 17</a>	<a href="#">3905 12 17</a>	22	8	24	0.038
	R1/2	<a href="#">3805 12 21</a>	<a href="#">3905 12 21</a>	22	10	23	0.046

## 3805

### Stud Fitting, Male NPT Thread



Stainless steel 316L, FKM

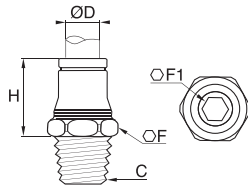

ØD	C		F	F1	H	Kg
4	NPT1/8	<a href="#">3805 04 11</a>	11	3	14.5	0.009
6	NPT1/8	<a href="#">3805 06 11</a>	13	4	18	0.012
	NPT1/4	<a href="#">3805 06 14</a>	14	4	16.5	0.017
8	NPT1/8	<a href="#">3805 08 11</a>	15	5	19	0.015
	NPT1/4	<a href="#">3805 08 14</a>	15	6	18	0.018
10	NPT1/4	<a href="#">3805 10 14</a>	19	6	24	0.028
	NPT3/8	<a href="#">3805 10 18</a>	19	7	22.5	0.031
	NPT1/4	<a href="#">3805 12 14</a>	22	7	25	0.035
12	NPT3/8	<a href="#">3805 12 18</a>	22	8	24	0.039
	NPT1/2	<a href="#">3805 12 22</a>	22	10	23	0.045

## 3805

### Stud Fitting, Male NPT Thread



Inch

Stainless steel 316L, FKM

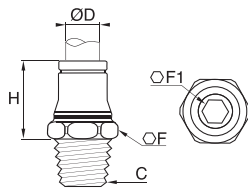

ØD	C		F	F1	H	Kg
3/16	NPT1/8	<a href="#">3805 55 11</a>	10	3	15.5	0.011
	NPT1/4	<a href="#">3805 55 14</a>	14	3	15.5	0.016
1/4	NPT1/8	<a href="#">3805 56 11</a>	13	4	19	0.012
	NPT1/4	<a href="#">3805 56 14</a>	14	4	17.5	0.018
3/8	NPT1/4	<a href="#">3805 60 14</a>	19	6	25	0.029
	NPT3/8	<a href="#">3805 60 18</a>	19	7	24	0.032
1/2	NPT1/4	<a href="#">3805 62 14</a>	22	7	26	0.036
	NPT3/8	<a href="#">3805 62 18</a>	22	8	25	0.041
	NPT1/2	<a href="#">3805 62 22</a>	22	10	25	0.050

5/32" (4 mm) and 5/16" (8 mm) also available

## 3801/3901 Stud Fitting, Male BSPP and Metric Thread



Stainless steel 316L, FKM

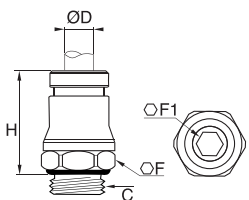

ØD	C			F	F1	H	Kg
4	M5x0.8	<a href="#">3801 04 19</a>	<a href="#">3901 04 19</a>	10	2.5	17	0.005
	G1/8	<a href="#">3801 04 10</a>	<a href="#">3901 04 10</a>	13	3	16.5	0.009
	M5x0.8	<a href="#">3801 06 19</a>	<a href="#">3901 06 19</a>	13	2.5	20.5	0.010
6	G1/8	<a href="#">3801 06 10</a>	<a href="#">3901 06 10</a>	13	4	18	0.010
	G1/4	<a href="#">3801 06 13</a>	<a href="#">3901 06 13</a>	17	4	18	0.015
	G1/8	<a href="#">3801 08 10</a>	<a href="#">3901 08 10</a>	15	5	19	0.013
8	G1/4	<a href="#">3801 08 13</a>	<a href="#">3901 08 13</a>	17	5	20.5	0.017
	G3/8	<a href="#">3801 08 17</a>	<a href="#">3901 08 17</a>	21	6	20	0.027
10	G1/4	<a href="#">3801 10 13</a>	<a href="#">3901 10 13</a>	19	7	25	0.025
	G3/8	<a href="#">3801 10 17</a>	<a href="#">3901 10 17</a>	21	7	25	0.035
12	G1/4	<a href="#">3801 12 13</a>	<a href="#">3901 12 13</a>	21	7	27	0.030
	G3/8	<a href="#">3801 12 17</a>	<a href="#">3901 12 17</a>	21	9	26.5	0.034

Other products are available upon request; please do not hesitate to consult us.

# Stud Fittings

## 3821/3921 Stud Standpipe, Male BSPT Thread



Stainless steel 316L

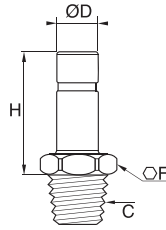

ØD	C			F	H	Kg
4	R1/8	<a href="#">3821 04 10</a>	<a href="#">3921 04 10</a>	10	21	0.006
	R1/4	<a href="#">3821 06 10</a>	<a href="#">3921 06 10</a>	10	23	0.007
6	R1/8	<a href="#">3821 06 13</a>	<a href="#">3921 06 13</a>	14	24	0.015
	R1/4	<a href="#">3821 08 10</a>	<a href="#">3921 08 10</a>	11	24	0.008
8	R1/4	<a href="#">3821 08 13</a>	<a href="#">3921 08 13</a>	14	25	0.016
	R1/4	<a href="#">3821 10 13</a>	<a href="#">3921 10 13</a>	19	30	0.017
10	R3/8	<a href="#">3821 10 17</a>	<a href="#">3921 10 17</a>	19	30	0.022
	R1/4	<a href="#">3821 12 13</a>	<a href="#">3921 12 13</a>	19	31	0.018
12	R3/8	<a href="#">3821 12 17</a>	<a href="#">3921 12 17</a>	19	31	0.022
	R1/2	<a href="#">3821 12 21</a>	<a href="#">3921 12 21</a>	22	32	0.040

## 3821/3921 Stud Standpipe, Male NPT Thread



Stainless steel 316L

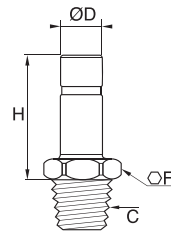

ØD	C			F	H	Kg
4	NPT1/8	<a href="#">3821 04 11</a>	<a href="#">3921 04 11</a>	10	21	0.006
	NPT1/4	<a href="#">3821 06 11</a>	<a href="#">3921 06 11</a>	10	23	0.007
6	NPT1/8	<a href="#">3821 06 14</a>	<a href="#">3921 06 14</a>	14	24	0.016
	NPT1/4	<a href="#">3821 08 11</a>	<a href="#">3921 08 11</a>	14	24	0.010
8	NPT1/4	<a href="#">3821 08 14</a>	<a href="#">3921 08 14</a>	14	25	0.016
	NPT1/4	<a href="#">3821 10 14</a>	<a href="#">3921 10 14</a>	14	30	0.017
10	NPT3/8	<a href="#">3821 10 18</a>	<a href="#">3921 10 18</a>	17	30	0.010
	NPT1/4	<a href="#">3821 12 14</a>	<a href="#">3921 12 14</a>	14	31	0.018
12	NPT3/8	<a href="#">3821 12 18</a>	<a href="#">3921 12 18</a>	17	31	0.026
	NPT1/2	<a href="#">3821 12 22</a>	<a href="#">3921 12 22</a>	22	32	0.050

## 3821 Stud Standpipe, Male NPT Thread



Inch

Stainless steel 316L

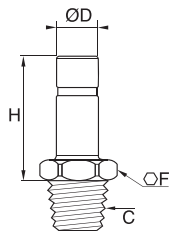

ØD	C		F	H	Kg
3/16	NPT1/8	<a href="#">3821 55 11</a>	10	25	0.009
	NPT1/8	<a href="#">3821 56 11</a>	10	26	0.009
1/4	NPT1/4	<a href="#">3821 56 14</a>	14	27	0.016
	NPT1/4	<a href="#">3821 60 14</a>	19	32	0.019
3/8	NPT3/8	<a href="#">3821 60 18</a>	19	32	0.029
	NPT1/4	<a href="#">3821 62 14</a>	19	36	0.033
1/2	NPT3/8	<a href="#">3821 62 18</a>	19	37	0.025
	NPT1/2	<a href="#">3821 62 22</a>	22	37	0.042

5/32"(4 mm) and 5/16"(8 mm) also available

## 3831/3931 Stud Standpipe, Male BSPP and Metric Thread



Stainless steel 316L, FKM

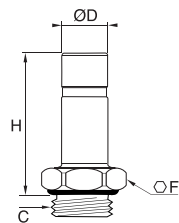

ØD	C			F	H	K	Kg
4	M5x0.8	<a href="#">3831 04 19</a>	<a href="#">3931 04 19</a>	7	23.5	8	0.004
	G1/8	<a href="#">3831 04 10</a>	<a href="#">3931 04 10</a>	13	22	14	0.008
	G1/4	<a href="#">3831 04 13</a>	<a href="#">3931 04 13</a>	17	22	18.5	0.016
6	G1/8	<a href="#">3831 06 10</a>	<a href="#">3931 06 10</a>	13	24	14	0.009
	G1/4	<a href="#">3831 06 13</a>	<a href="#">3931 06 13</a>	17	24	18.5	0.015
8	G1/8	<a href="#">3831 08 10</a>	<a href="#">3931 08 10</a>	13	25	14	0.010
	G1/4	<a href="#">3831 08 13</a>	<a href="#">3931 08 13</a>	17	27	18.5	0.019
	G3/8	<a href="#">3831 08 17</a>	<a href="#">3931 08 17</a>	21	27	23	0.024
10	G1/4	<a href="#">3831 10 13</a>	<a href="#">3931 10 13</a>	17	32	18.5	0.020
	G3/8	<a href="#">3831 10 17</a>	<a href="#">3931 10 17</a>	21	27	23	0.025
12	G1/4	<a href="#">3831 12 13</a>	<a href="#">3931 12 13</a>	17	33	18.5	0.021
	G3/8	<a href="#">3831 12 17</a>	<a href="#">3931 12 17</a>	21	33	23	0.028
	G1/2	<a href="#">3831 12 21</a>	<a href="#">3931 12 21</a>	24	36	26	0.043

LF 3800 : 316L stainless steel (body) with 303 stainless steel collet, FKM seals  
 LF 3900 : full 316L, FKM seals

# Stud Fittings

## 3800/3900 One-Piece Cartridge



Stainless steel 316L, FKM

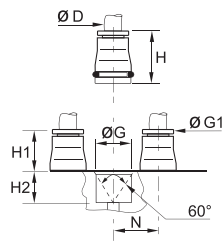

ØD			G	G1	H	H1	H2	N	Kg
4	<a href="#">3800 04 00</a>	<a href="#">3900 04 00</a>	9.8	8	17	8.5	8.5	11	0.006
6	<a href="#">3800 06 00</a>	<a href="#">3900 06 00</a>	12.1	10	19	10.5	8.5	13.5	0.008
8	<a href="#">3800 08 00</a>	<a href="#">3900 08 00</a>	14.8	13	21	12.5	8.5	16	0.012
10	<a href="#">3800 10 00</a>	<a href="#">3900 10 00</a>	17.5	15	24.5	14	10.5	20	0.019
12	<a href="#">3800 12 00</a>	<a href="#">3900 12 00</a>	20	17	25	14.5	10.5	22.5	0.022

3800: collet in stainless steel 303  
 3900: collet in stainless steel 316L  
 Cavity dimensions are available in chapter 2.

## 3809/3909 Stud Elbow, Male BSPT Thread



Stainless steel 316L, FKM

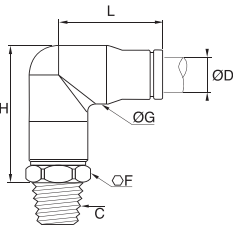

ØD	C			F	G	H	L	Kg
4	R1/8	<a href="#">3809 04 10</a>	<a href="#">3909 04 10</a>	10	10	23.5	16.5	0.020
	R1/4	<a href="#">3809 06 10</a>	<a href="#">3909 06 10</a>	13	12	27.5	20	0.031
6	R1/4	<a href="#">3809 06 13</a>	<a href="#">3909 06 13</a>	14	12	27.5	25	0.036
	R1/8	<a href="#">3809 08 10</a>	<a href="#">3909 08 10</a>	14	15	32	25	0.040
8	R1/4	<a href="#">3809 08 13</a>	<a href="#">3909 08 13</a>	14	14.5	34	25	0.045
	R1/8	<a href="#">3809 10 13</a>	<a href="#">3909 10 13</a>	19	17.5	37.5	27.5	0.069
10	R3/8	<a href="#">3809 10 17</a>	<a href="#">3909 10 17</a>	19	17.5	37.5	27.5	0.070

The body swivels for positioning purposes.

## 3809 Stud Elbow, Male NPT Thread



Stainless steel 316L, FKM

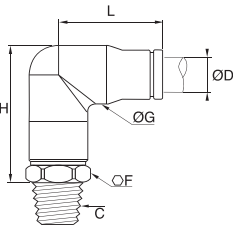

ØD	C			F	G	H	L	Kg
4	NPT1/8	<a href="#">3809 04 11</a>		11	10	25.5	18.5	0.021
	NPT1/8	<a href="#">3809 06 11</a>		13	12.5	29	22.5	0.031
6	NPT1/4	<a href="#">3809 06 14</a>		14	12.5	29	22.5	0.036
	NPT1/8	<a href="#">3809 08 11</a>		14	15	34	24	0.040
8	NPT1/4	<a href="#">3809 08 14</a>		14	15	34	24	0.045
	NPT1/4	<a href="#">3809 10 14</a>		19	17.5	39.5	30	0.068
10	NPT3/8	<a href="#">3809 10 18</a>		19	17.5	39.5	30	0.071

The body swivels for positioning purposes.

## 3899/3999 Stud Elbow, Male BSPP and Metric Thread



Stainless steel 316L, FKM

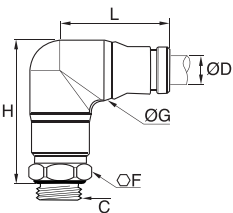

ØD	C			F	G	H	L	Kg
4	M5x0.8	<a href="#">3899 04 19</a>	<a href="#">3999 04 19</a>	10	10	26	18	0.020
	G1/8	<a href="#">3899 04 10</a>	<a href="#">3999 04 10</a>	13	10	27	19	0.022
	G1/4	<a href="#">3899 04 13</a>	<a href="#">3999 04 13</a>	17	10	27	19	0.018
6	M5x0.8	<a href="#">3899 06 19</a>	<a href="#">3999 06 19</a>	13	12	33	24	0.031
	G1/8	<a href="#">3899 06 10</a>	<a href="#">3999 06 10</a>	6	12	33	24	0.031
	G1/4	<a href="#">3899 06 13</a>	<a href="#">3999 06 13</a>	17	12	32	24	0.036
8	G1/8	<a href="#">3899 08 10</a>	<a href="#">3999 08 10</a>	14	15	35	25	0.039
	G1/4	<a href="#">3899 08 13</a>	<a href="#">3999 08 13</a>	17	15	35	25	0.044
	G3/8	<a href="#">3899 08 17</a>	<a href="#">3999 08 17</a>	21	15	34.5	25	0.049
10	G1/4	<a href="#">3899 10 13</a>	<a href="#">3999 10 13</a>	19	17	43	31	0.067
	G3/8	<a href="#">3899 10 17</a>	<a href="#">3999 10 17</a>	21	17	42	31	0.072

The body swivels for positioning purposes.

Stud standpipe 3821, 3921, 3831, 3931 can be used as illustrated, allowing:

- stock optimisation
- installation of tees and elbows where required

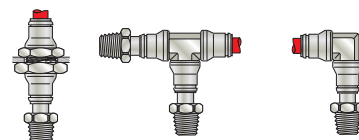



# Stud Fittings

## 3889/3989

### Compact Stud Elbow, Male BSPT Thread



Stainless steel 316L, FKM

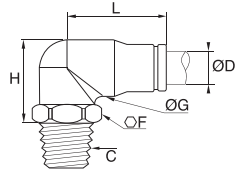

ØD	C			F	G	H	L	Kg
4	R1/8	<a href="#">3889 04 10</a>	<a href="#">3989 04 10</a>	13	10	18	17	0.019
	R1/4	<a href="#">3889 04 13</a>	<a href="#">3989 04 13</a>	17	10	19.5	16.5	0.018
6	R1/8	<a href="#">3889 06 10</a>	<a href="#">3989 06 10</a>	13	12	21.5	20.5	0.026
	R1/4	<a href="#">3889 06 13</a>	<a href="#">3989 06 13</a>	14	12	21.5	20.5	0.032
8	R1/8	<a href="#">3889 08 10</a>	<a href="#">3989 08 10</a>	14	15	24	22	0.035
	R1/4	<a href="#">3889 08 13</a>	<a href="#">3989 08 13</a>	14	15	24	22	0.035
10	R1/4	<a href="#">3889 10 13</a>	<a href="#">3989 10 13</a>	17	17.5	28.5	27.5	0.057
	R3/8	<a href="#">3889 10 17</a>	<a href="#">3989 10 17</a>	19	17.5	28.5	27.5	0.067
12	R1/4	<a href="#">3889 12 13</a>	<a href="#">3989 12 13</a>	22	20	33.5	30	0.088
	R3/8	<a href="#">3889 12 17</a>	<a href="#">3989 12 17</a>	22	20	33.5	30	0.090
	R1/2	<a href="#">3889 12 21</a>	<a href="#">3989 12 21</a>	22	20	33.5	33	0.097

The body swivels for positioning purposes.  
Max. 20 bar

## 3889

### Compact Male Stud Elbow, Male NPT Thread



Stainless steel 316L, FKM

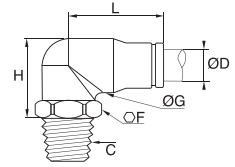

ØD	C		F	G	H	L	Kg
4	NPT1/8	<a href="#">3889 04 11</a>	13	10	17.5	19	0.020
6	NPT1/8	<a href="#">3889 06 11</a>	13	12.5	20	22.5	0.026
	NPT1/4	<a href="#">3889 06 14</a>	14	12.5	20	22.5	0.034
8	NPT1/8	<a href="#">3889 08 11</a>	13	15	25	24	0.035
	NPT1/4	<a href="#">3889 08 14</a>	14	15	24	24	0.036
10	NPT1/4	<a href="#">3889 10 14</a>	17	17.5	27.5	27.5	0.059
	NPT3/8	<a href="#">3889 10 18</a>	19	17.5	28.5	26.5	0.067
12	NPT1/4	<a href="#">3889 12 14</a>	22	20	31.5	32.5	0.086
	NPT3/8	<a href="#">3889 12 18</a>	22	20	32.5	32.5	0.089
	NPT1/2	<a href="#">3889 12 22</a>	22	20	27.5	32.5	0.098

The body swivels for positioning purposes.  
Max. 20 bar

## 3889

### Compact Stud Elbow, Male NPT Thread



Inch

Stainless steel 316L, FKM

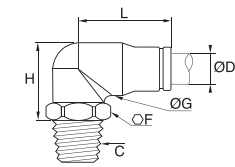

ØD	C		F	G	H	L	Kg
3/16	NPT1/8	<a href="#">3889 55 11</a>	10	10	21	20	0.020
	NPT1/4	<a href="#">3889 55 14</a>	14	10	21	20	0.025
1/4	NPT1/8	<a href="#">3889 56 11</a>	13	12	22	23	0.025
	NPT1/4	<a href="#">3889 56 14</a>	14	12	22	23	0.033
3/8	NPT1/4	<a href="#">3889 60 14</a>	17	17.5	28	30.5	0.059
	NPT3/8	<a href="#">3889 60 18</a>	19	17.5	28	30.5	0.067
1/2	NPT1/4	<a href="#">3889 62 14</a>	22	20	34	33	0.089
	NPT3/8	<a href="#">3889 62 18</a>	22	20	34	33	0.089
	NPT1/2	<a href="#">3889 62 22</a>	22	20	27	33	0.091

The body swivels for positioning purposes.  
5/32" (4 mm) and 5/16" (8 mm) also available.  
Max. 20 bar

## 3879/3979

### Compact Stud Elbow, Male BSPP Thread



FKM, stainless steel 316L

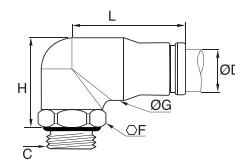

ØD	C			F	G	H	L	Kg
4	G1/8	<a href="#">3879 04 10</a>	<a href="#">3979 04 10</a>	10	11	22	19	0.021
	G1/4	<a href="#">3879 04 13</a>	<a href="#">3979 04 13</a>	17	11	20	19	0.027
6	G1/8	<a href="#">3879 06 10</a>	<a href="#">3979 06 10</a>	13	12	24	24	0.029
	G1/4	<a href="#">3879 06 13</a>	<a href="#">3979 06 13</a>	17	12	22	24	0.034
8	G1/8	<a href="#">3879 08 10</a>	<a href="#">3979 08 10</a>	13	15	25	25	0.035
	G1/4	<a href="#">3879 08 13</a>	<a href="#">3979 08 13</a>	17	15	25	25	0.039
	G3/8	<a href="#">3879 08 17</a>	<a href="#">3979 08 17</a>	21	15	23	25	0.047
10	G1/4	<a href="#">3879 10 13</a>	<a href="#">3979 10 13</a>	18	17	43	31	0.058
	G3/8	<a href="#">3879 10 17</a>	<a href="#">3979 10 17</a>	21	17	40	31	0.066
12	G1/4	<a href="#">3879 12 13</a>	<a href="#">3979 12 13</a>	17	20	33	33	0.077
	G3/8	<a href="#">3879 12 17</a>	<a href="#">3979 12 17</a>	21	20	33	33	0.082
	G1/2	<a href="#">3879 12 21</a>	<a href="#">3979 12 21</a>	24	20	30	33	0.097

The body swivels for positioning purposes.  
Max. 20 bar

# Stud Fittings

## 3803/3903 Stud Run Tee, Male BSPT Thread



Stainless steel 316L, FKM

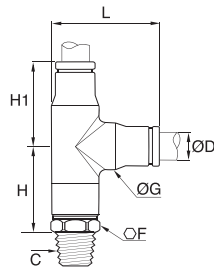

ØD	C			F	G	H	H1	L	Kg
4	R1/8	<a href="#">3803 04 10</a>	<a href="#">3903 04 10</a>	10	10	19	17	22	0.020
	R1/8	<a href="#">3803 06 10</a>	<a href="#">3903 06 10</a>	13	12	22	20	26.5	0.038
6	R1/4	<a href="#">3803 06 13</a>	<a href="#">3903 06 13</a>	14	15	22	20	27	0.035
	R1/8	<a href="#">3803 08 10</a>	<a href="#">3903 08 10</a>	14	15	24	23	31	0.049
8	R1/4	<a href="#">3803 08 13</a>	<a href="#">3903 08 13</a>	14	15	24	23	31	0.055
	R1/4	<a href="#">3803 10 13</a>	<a href="#">3903 10 13</a>	19	17.5	30	29	38	0.070
10	R3/8	<a href="#">3803 10 17</a>	<a href="#">3903 10 17</a>	19	17.5	30	29	38	0.083

The body swivels for positioning purposes.

## 3803 Stud Run Tee, Male NPT Thread



Stainless steel 316L, FKM

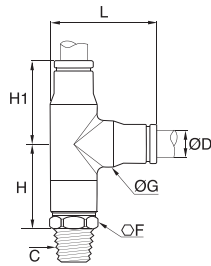

ØD	C			F	G	H	H1	L	Kg
4	NPT1/8	<a href="#">3803 04 11</a>		11	10	21	19	25	0.021
	NPT1/8	<a href="#">3803 06 11</a>		13	12	24	21	27	0.038
6	NPT1/4	<a href="#">3803 06 14</a>		14	12	24	21	27.5	0.037
	NPT1/8	<a href="#">3803 08 11</a>		14	15	26.5	24	30.5	0.050
8	NPT1/4	<a href="#">3803 08 14</a>		14	15	26.5	24	30.5	0.048
	NPT1/4	<a href="#">3803 10 14</a>		19	17.5	31	29.5	37.5	0.082

The body swivels for positioning purposes.

## 3893/3993 Stud Run Tee, Male BSPP and Metric Thread



Stainless steel 316L, FKM

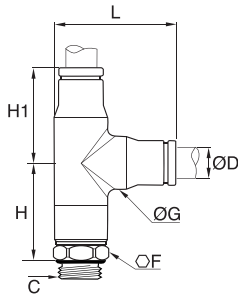

ØD	C			F	G	H	H1	L	Kg
4	M5x0.8	<a href="#">3893 04 19</a>	<a href="#">3993 04 19</a>	10	11	21.5	19	24.5	0.023
	G1/8	<a href="#">3893 04 10</a>	<a href="#">3993 04 10</a>	13	11	21.5	19	24.5	0.026
	G1/4	<a href="#">3893 04 13</a>	<a href="#">3993 04 13</a>	17	11	22	19	28	0.033
6	G1/8	<a href="#">3893 06 10</a>	<a href="#">3993 06 10</a>	13	12	26.5	24	30	0.038
	G1/4	<a href="#">3893 06 13</a>	<a href="#">3993 06 13</a>	17	12	26	24	32	0.043
8	G1/8	<a href="#">3893 08 10</a>	<a href="#">3993 08 10</a>	14	15	27.5	25	32	0.049
	G1/8	<a href="#">3893 08 13</a>	<a href="#">3993 08 13</a>	17	15	28	25	33.5	0.053
10	G3/8	<a href="#">3893 08 17</a>	<a href="#">3993 08 17</a>	21	15	27	25	35.5	0.094
	G1/4	<a href="#">3893 10 13</a>	<a href="#">3993 10 13</a>	19	17	34	31	39	0.081
	G3/8	<a href="#">3893 10 17</a>	<a href="#">3993 10 17</a>	21	17	35.5	31	39.5	0.082

The body swivels for positioning purposes.

## 3808/3908 Stud Branch Tee, Male BSPT Thread



Stainless steel 316L, FKM

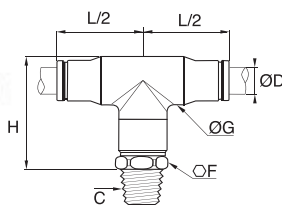

ØD	C			F	G	H	L/2	Kg
4	R1/8	<a href="#">3808 04 10</a>	<a href="#">3908 04 10</a>	10	10	23.5	19	0.020
	R1/8	<a href="#">3808 06 10</a>	<a href="#">3908 06 10</a>	13	12	27.5	24	0.038
6	R1/4	<a href="#">3808 06 13</a>	<a href="#">3908 06 13</a>	14	12	27.5	24	0.044
	R1/8	<a href="#">3808 08 10</a>	<a href="#">3908 08 10</a>	14	15	32	25	0.049
8	R1/4	<a href="#">3808 08 13</a>	<a href="#">3908 08 13</a>	14	15	32	25	0.055
	R3/8	<a href="#">3808 08 17</a>	<a href="#">3908 08 17</a>	19	15	33	25	0.068
10	R1/4	<a href="#">3808 10 13</a>	<a href="#">3908 10 13</a>	19	17.5	37.5	31	0.082
	R3/8	<a href="#">3808 10 17</a>	<a href="#">3908 10 17</a>	19	17.5	37.5	31	0.083

The body swivels for positioning purposes.

These models enable compact connection for elbow outlets, thus allowing space saving.

# Stud Fittings

## 3808

### Stud Branch Tee, Male BSPT Thread



Stainless steel 316L, FKM

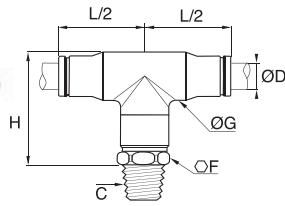

ØD	C		F	G	H	L/2	Kg
4	NPT1/8	<a href="#">3808 04 11</a>	11	10	22	19	0.026
6	NPT1/8	<a href="#">3808 06 11</a>	13	12.5	30	24	0.031
	NPT1/4	<a href="#">3808 06 14</a>	14	12.5	30	24	0.044
8	NPT1/8	<a href="#">3808 08 11</a>	14	15	34	25	0.042
	NPT1/4	<a href="#">3808 08 14</a>	14	15	34	25	0.054
10	NPT1/4	<a href="#">3808 10 14</a>	19	17.5	40	31	0.082
	NPT3/8	<a href="#">3808 10 18</a>	19	17.5	40	31	0.084

The body swivels for positioning purposes.

## 3898/3998

### Stud Branch Tee, Male BSPP and Metric Thread



Stainless steel 316L, FKM

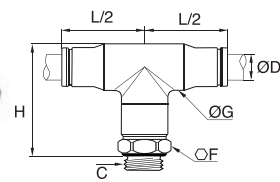

ØD	C			F	G	H	L/2	Kg
4	M5x0.8	<a href="#">3898 04 19</a>	<a href="#">3998 04 19</a>	10	11	27	19	0.024
	G1/8	<a href="#">3898 04 10</a>	<a href="#">3998 04 10</a>	13	11	27	19	0.026
	G1/4	<a href="#">3898 04 13</a>	<a href="#">3998 04 13</a>	17	11	27	19	0.032
6	M5x0.8	<a href="#">3898 06 19</a>	<a href="#">3998 06 19</a>	13	12	33.5	24	0.038
	G1/8	<a href="#">3898 06 10</a>	<a href="#">3998 06 10</a>	13	12	33	24	0.038
	G1/4	<a href="#">3898 06 13</a>	<a href="#">3998 06 13</a>	17	12	32	24	0.043
8	G1/8	<a href="#">3898 08 10</a>	<a href="#">3998 08 10</a>	14	15	35	25	0.051
	G1/4	<a href="#">3898 08 13</a>	<a href="#">3998 08 13</a>	17	15	35	25	0.053
	G3/8	<a href="#">3898 08 17</a>	<a href="#">3998 08 17</a>	21	15	34.5	25	0.058
10	G1/4	<a href="#">3898 10 13</a>	<a href="#">3998 10 13</a>	19	17	43	31	0.082
	G3/8	<a href="#">3898 10 17</a>	<a href="#">3998 10 17</a>	21	17	41	31	0.087

The body swivels for positioning purposes.

LF 3800 : 316L stainless steel (body) with 303 stainless steel collet, FKM seals  
 LF 3900 : full 316L, FKM seals

# Tube-to-Tube Fittings

## 3806/3906 Equal Straight Connector



Stainless steel 316L, FKM

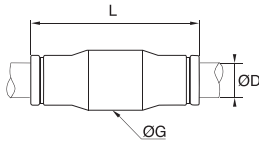

ØD			G	L	Kg
4	<a href="#">3806 04 00</a>	<a href="#">3906 04 00</a>	10	29	0.009
6	<a href="#">3806 06 00</a>	<a href="#">3906 06 00</a>	12	34	0.015
8	<a href="#">3806 08 00</a>	<a href="#">3906 08 00</a>	15	36	0.019
10	<a href="#">3806 10 00</a>	<a href="#">3906 10 00</a>	17.5	45	0.033
12	<a href="#">3806 12 00</a>	<a href="#">3906 12 00</a>	20	46.5	0.040

## 3806/3906 Equal Straight Connector



Stainless steel 316L, FKM

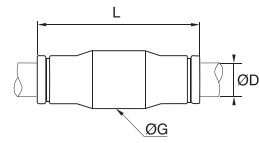

ØD			G	L	Kg
3/16	<a href="#">3806 55 00</a>	<a href="#">3906 55 00</a>	11	31	0.010
1/4	<a href="#">3806 56 00</a>	<a href="#">3906 56 00</a>	12	36	0.015
3/8	<a href="#">3806 60 00</a>	<a href="#">3906 60 00</a>	17	47	0.030
1/2	<a href="#">3806 62 00</a>	<a href="#">3906 62 00</a>	20	48	0.039

5/32" (4 mm) and 5/16" (8 mm) also available

## 3802/3902 Equal Stud Elbow



Stainless steel 316L, FKM

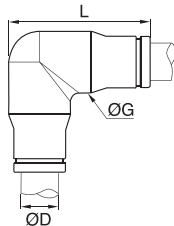

ØD			G	L	Kg
4	<a href="#">3802 04 00</a>	<a href="#">3902 04 00</a>	10	21.5	0.015
6	<a href="#">3802 06 00</a>	<a href="#">3902 06 00</a>	12	26.5	0.024
8	<a href="#">3802 08 00</a>	<a href="#">3902 08 00</a>	15	29.5	0.031
10	<a href="#">3802 10 00</a>	<a href="#">3902 10 00</a>	17.5	36.5	0.050
12	<a href="#">3802 12 00</a>	<a href="#">3902 12 00</a>	20	40	0.072

## 3802/3902 Equal Stud Elbow,



Stainless steel 316L, FKM

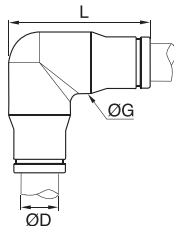

ØD			G	L	Kg
3/16	<a href="#">3802 55 00</a>	<a href="#">3902 55 00</a>	11	25	0.011
1/4	<a href="#">3802 56 00</a>	<a href="#">3902 56 00</a>	12	29	0.024
3/8	<a href="#">3802 60 00</a>	<a href="#">3902 60 00</a>	17	38	0.047
1/2	<a href="#">3802 62 00</a>	<a href="#">3902 62 00</a>	20	43	0.071

5/32" (4 mm) and 5/16" (8 mm) also available

## 3804/3904 Equal Tee



Stainless steel 316L, FKM

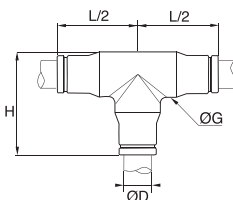

ØD			G	H	L/2	Kg
4	<a href="#">3804 04 00</a>	<a href="#">3904 04 00</a>	10	22	19	0.020
6	<a href="#">3804 06 00</a>	<a href="#">3904 06 00</a>	12	26	24	0.031
8	<a href="#">3804 08 00</a>	<a href="#">3904 08 00</a>	15	29.5	25	0.040
10	<a href="#">3804 10 00</a>	<a href="#">3904 10 00</a>	17.5	36.5	31	0.064
12	<a href="#">3804 12 00</a>	<a href="#">3904 12 00</a>	20	40	33	0.088

# Bulkhead Connector Fittings

## 3804/3904

### Equal Tee



Stainless steel 316L, FKM

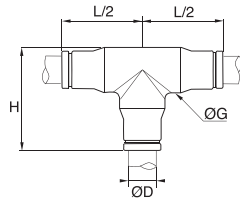

ØD			G	H	L/2	Kg
3/16	3804 55 00	3904 55 00	11	25	20	0.017
1/4	3804 56 00	3904 56 00	12	30	23	0.031
3/8	3804 60 00	3904 60 00	17	38	29	0.059
1/2	3804 62 00	3904 62 00	20	43	33	0.089

5/32" (4 mm) and 5/16" (8 mm) also available

## 3816/3916

### Equal Bulkhead Connector



Stainless steel 316L, FKM

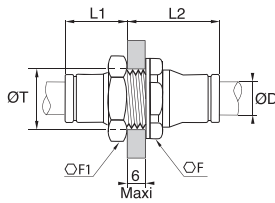

ØD			F	F1	L1	L2	ØT	Kg
4	3816 04 00	3916 04 00	13	14	13.5	19.5	13	0.017
6	3816 06 00	3916 06 00	17	17	16.5	21.5	14	0.027
8	3816 08 00	3916 08 00	19	19	18	24	16	0.034
10	3816 10 00	3916 10 00	22	22	21.5	27.5	21	0.049
12	3816 12 00	3916 12 00	24	24	24	29	23	0.059

IP55 sealing

## 3816/3916

### Equal Bulkhead Connector



Stainless steel 316L, FKM

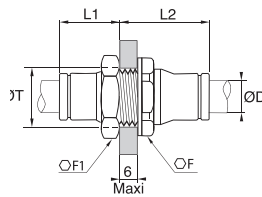

ØD			F	F1	L1	L2	ØT	Kg
3/16	3816 55 00	3916 55 00	17	13	15	18	12.5	0.017
1/4	3816 56 00	3916 56 00	19	17	19	21	15	0.026
3/8	3816 60 00	3916 60 00	22	22	22	27	21	0.052
1/2	3816 62 00	3916 62 00	27	27	25	28	25	0.076

IP55 sealing

5/32" (4 mm) and 5/16" (8 mm) also available

LF 3800/LF 3900 push-in fittings allow connection with several types of Parker Legris tubing shown in Chapter 3 of this catalogue, "Technical Tubing and Hose":

- PFA tubing
- Fluoropolymer tubing
- Polyethylene tubing
- Semi-rigid polyamide and flexible Crystal polyurethane tubing

# Plug-In Fittings and Accessories

## 3866/3966 Push-In Reducer



Stainless steel 316L, FKM

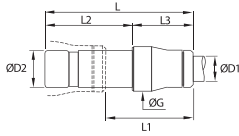

ØD1	ØD2			G	L	L1	L2	L3	Kg
4	6	<a href="#">3866 04 06</a>	<a href="#">3966 04 06</a>	10	35	19	19	16	0.009
	8	<a href="#">3866 04 08</a>	<a href="#">3966 04 08</a>	10	34	17	20	14	0.011
6	8	<a href="#">3866 06 08</a>	<a href="#">3966 06 08</a>	12	42	24	23	19	0.015
	10	<a href="#">3866 06 10</a>	<a href="#">3966 06 10</a>	12	41	19	25	16	0.019
8	10	<a href="#">3866 08 10</a>	<a href="#">3966 08 10</a>	15	45	22.5	25	20	0.020
	12	<a href="#">3866 08 12</a>	<a href="#">3966 08 12</a>	15	43	20	26	17	0.025
10	12	<a href="#">3866 10 12</a>	<a href="#">3966 10 12</a>	17	50	23	26	24	0.029

## 3826 Blanking Plug



Stainless steel 316L

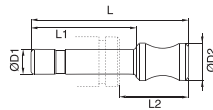

ØD1	ØD2		L	L1	L2	Kg
4	6	<a href="#">3826 04 00</a>	25	17	11	0.003
6	8	<a href="#">3826 06 00</a>	30.4	19.5	13.5	0.007
8	10	<a href="#">3826 08 00</a>	33	20	14	0.014
10	12	<a href="#">3826 10 00</a>	40	25	17	0.025
12	14	<a href="#">3826 12 00</a>	43	26	19	0.038

## 3800 Pre-Grooving Tool for Metallic Tubing

Treated steel

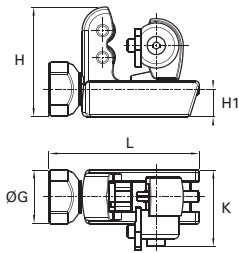

	G	H	H1	K	L	Kg
<a href="#">3800 70 00</a>	25	51	13	36	70	0.326

This tool correctly pre-grooves 4-12 mm O.D. and 3/16"-1/2" O.D. stainless steel tubing, to ensure that the LF 3800/LF 3900 collet grips the tube securely.

## 0605 Fluoropolymer Tape

FKM



	Kg
<a href="#">0605 12 12</a>	0.012

Can be used for temperatures from - 250°C to +260°C.  
Chemically inert and resistant to gases, acids, solvents, hydrocarbons, oils, alkalines, steam etc.  
Non-toxic, waterproof, self-lubricating.  
In accordance with CFR21.  
Can be used on all materials.  
Used to facilitate the preparation of leak-free threaded joints.  
Supplied on a reel, length = 12 m, width = 12.7 mm, thickness 0.08 mm.

## 3000 70 Dismounting Tool

Treated steel

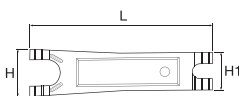

	H	H1	L	Kg
<a href="#">3000 70 00</a>	25	20	96	0.021

For dismantling LF 3000® tubing/fittings where access is difficult, we recommend the use of this dismounting tool.







# Cartridges and Customised Products





# Cartridges

## Polymer Cartridges

### Compressed Air

**3100**  
Carstick®  
Page 2-8



**3086**  
Quick Fitting  
Page 2-8



**3089**  
Quick Fitting  
Page 2-8



**3082**  
Quick Fitting  
Page 2-8



**3081**  
Quick Fitting  
Page 2-9



**3088**  
Quick Fitting  
Page 2-9



**3100 - Inch**  
Carstick®  
Page 2-8



### Fluids and Gases

**6300**  
Carstick® LIQUIfit®  
Page 2-10



**6300 - Inch**  
Carstick® LIQUIfit®  
Page 2-10



## Metal Cartridges

### Fluids and Gases

**3600**  
Page 2-13



**3800**  
**3900**  
Page 2-13



**FTL**  
Page 2-13



**TLT**  
Disconnection  
Tool  
Page 2-13



# Polymer Cartridges: LF 3000® and LIQUIfit® Carstick®, Quick Fitting

Parker Legris has developed the range of patented **Carstick®** cartridges guaranteeing **the integrity of the sealing system** before and after assembly in non-threaded cavities. The **compact design** of the one-piece Carstick® cartridge enables **automation** of your manufacturing process and improves the **reliability** of your system.

## Product Advantages

- Time-Saving**
  - No thread to be machined for inserting the fitting into its cavity
  - Seal pre-assembled, greased and protected
  - Self-centring of the cartridge in the cavity
  - Product protected against contamination, from manufacture to installation
  - Possible to have several tube diameters in the same cavity (Quick Fitting)
- Proven Technology**
  - Technical performances of the LF 3000®
  - Push-in connection
  - Full flow
  - Optimum flow at pressure and vacuum
  - LIQUIfit® Carstick® compatible with drinking water and food fluids
- Automated Installation**
  - Ensures that the product will be correctly assembled
  - Connection fully integrated in the cavity
  - Carstick® packaging designed for an automatic assembly process



**Applications**

- Robotics
- Automotive Process
- Pneumatics
- Semi-Conductors
- Water & Beverage
- Packaging
- Vacuum

## Technical Characteristics

	LF 3000® Carstick® and Quick Fitting	LIQUIfit® Carstick®
<b>Compatible Fluids</b>	Compressed air	Food fluids, inert gases
<b>Working Pressure</b>	Vacuum to 20 bar	Vacuum to 16 bar*
<b>Working Temperature</b>	-20°C to +80°C	-10°C to +95°C*

Reliable performance is dependent upon the type of fluid conveyed, component materials and tubing being used. Guaranteed for use with a vacuum of 755 mm Hg (99% vacuum). \*The pressure / temperature information is shown in Chapter 1, in the "LIQUIfit®" section.

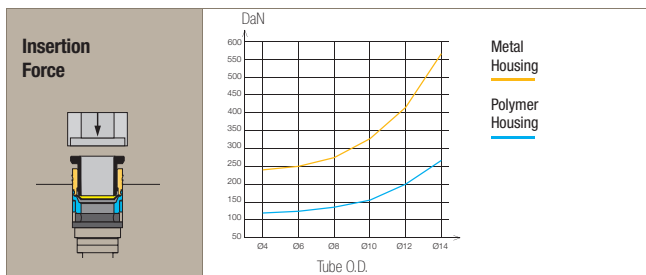

### Component Materials

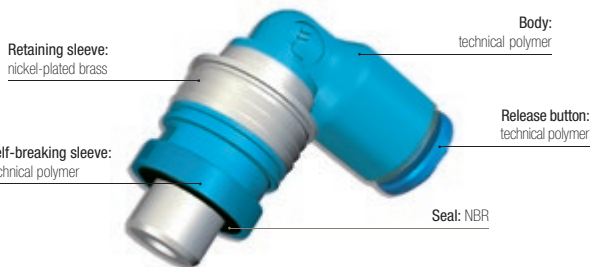
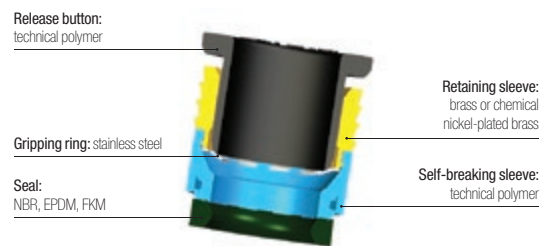

**Silicone-free**

### Regulations

#### LF 3000® Carstick® and Quick Fitting

ISO 14743: Pneumatic fluid power, push-in fittings for thermoplastic tubes  
 DI: 2002/95/CE (RoHS), 2011/65/CE  
 DI: 97/23/CE (PED)

#### LIQUIfit® Carstick®

RG: 1935/2004/CE  
 FDA: 21 CFR 177.1550  
 NSF 51 to 95°C  
 ACS  
 DM 174 (Italy)

DI: 2002/95/CE (RoHS), 2011/65/CE

DI: 97/23/CE (PED)

WRAS

NSF/ANSI 61 - C HOT

KTW: cartridges on request

# Assembly Options

Cartridge solutions quickly pay for themselves when they enable production to be rationalised:

## Threaded Fittings

**For small quantities or non-standard assembly operations:**  
The threaded solution remains the most advantageous.

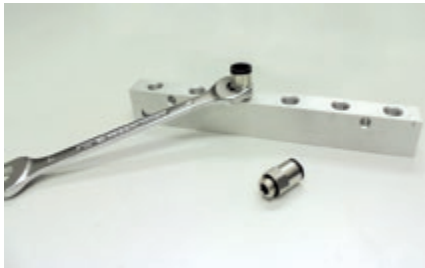

## Carstick®: Manual Assembly

**For medium quantities:**  
Assembly by manually-operated press offers the most economic solution.



## Carstick®: Automated Assembly

**For repetitive operations and large quantities:**  
Investment in an automated manufacturing solution is quickly recovered, providing significant long-term savings.

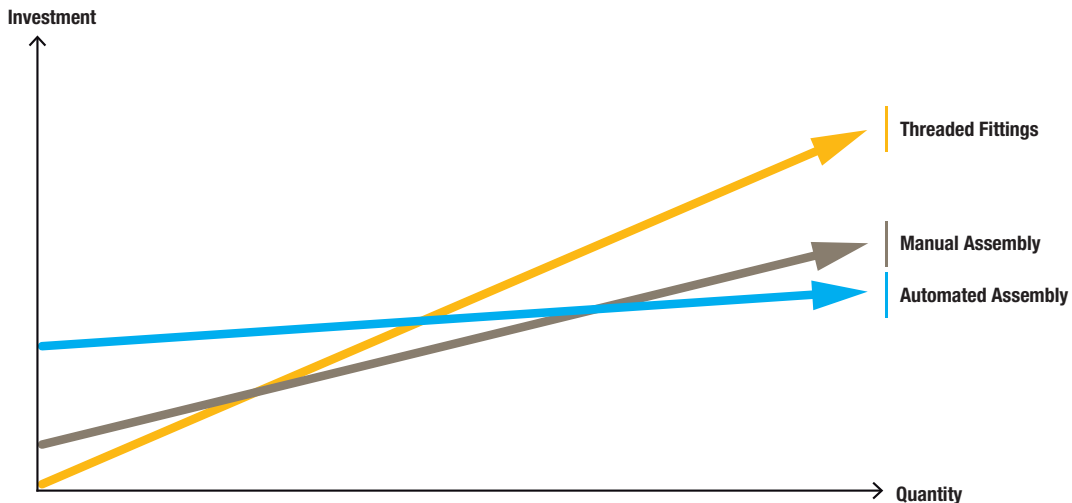

## Installation

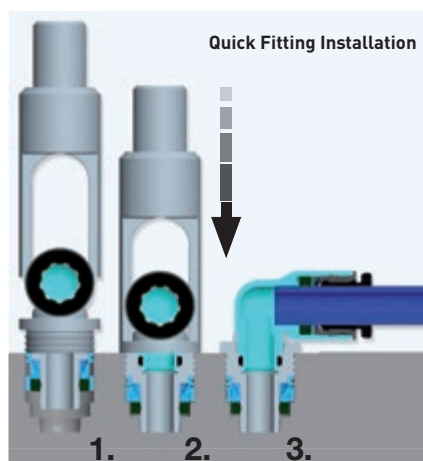
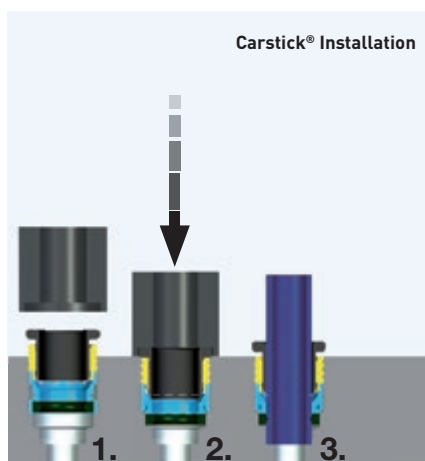

1. Self-centering of the cartridge in the cavity.
2. The seal protection is broken.  
The seal slides into the cavity.  
The cartridge is in place.



3. Tube connection.

**Assembly tool:**  
For details on the assembly tool, please contact us.



**Assembly tool:**  
For details on the assembly tool, please contact us.





# Polymer Cartridges for Compressed Air

## 3100 Carstick® Cartridge

Brass, NBR

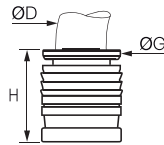

ØD		G	G1	H	L	kg
4	<a href="#">3100 04 00</a>	8	11	10	554	0.001
6	<a href="#">3100 06 00</a>	10	14.5	11.5	629	0.002
8	<a href="#">3100 08 00</a>	13	15	15	794	0.002
10	<a href="#">3100 10 00</a>	15.5	19.5	17	930	0.005
12	<a href="#">3100 12 00</a>	19.5	21	19.5	1038	0.010
14	<a href="#">3100 14 00</a>	21	24.5	22.5	1110	0.013

50 cartridges per Carstick®.

For cartridge Ø14, please consult us for the cavity dimensions.



## 3100 Carstick® Cartridge

Nickel-plated brass, NBR

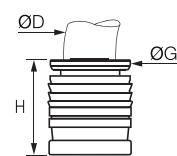

ØD		G	G1	H	L	kg
1/8	<a href="#">3100 53 00 99</a>	7	10	9	508	0.002
1/4	<a href="#">3100 56 00 99</a>	10.5	14.5	12	600	0.003
3/8	<a href="#">3100 60 00 99</a>	15.5	19	16.5	930	0.006

50 cartridges per Carstick®.

5/32" (4 mm) and 5/16" (8 mm) also available.



## 3086 Quick Fitting Reducer

Nickel-plated brass, NBR

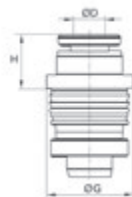

ØD		Cavity	G	H	kg
4	<a href="#">3086 04 06</a>	6	12.5	7	0.005
6	<a href="#">3086 06 08</a>	8	14	7.5	0.008

Available on request

## 3089 Quick Fitting Elbow

Technical polymer, nickel-plated brass, NBR

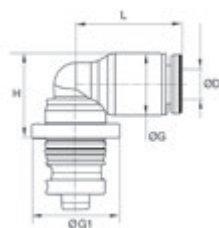

ØD		Cavity	G	G1	H	L	kg
4	<a href="#">3089 04 04</a>	4	9	12.5	11.5	15	0.004
	<a href="#">3089 04 06</a>	6	9	12.5	11.5	15	0.005
	<a href="#">3089 06 04</a>	4	11	12.5	14	17	0.004
6	<a href="#">3089 06 06</a>	6	11	12.5	12.5	17	0.006
	<a href="#">3089 06 08</a>	8	11	14.5	13	17	0.010
8	<a href="#">3089 08 08</a>	8	13.5	14.5	16	23	0.011
	<a href="#">3089 08 10</a>	10	13.5	19	16	23	0.021
10	<a href="#">3089 10 10</a>	10	16	19	19	26.5	0.017
	<a href="#">3089 10 12</a>	12	16	20	19	26.5	0.028
12	<a href="#">3089 12 12</a>	12	19	20	22	31	0.030

## 3082 Quick Fitting Extended Elbow

Technical polymer, nickel-plated brass, NBR

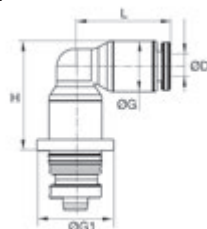

ØD		Cavity	G	G1	H	L	kg
4	<a href="#">3082 04 04</a>	4	9	12.5	16	15	0.006
	<a href="#">3082 04 06</a>	6	9	12.5	15	15	0.009
6	<a href="#">3082 06 06</a>	6	9	12.5	23	19	0.010
	<a href="#">3082 06 08</a>	8	10.5	14	29	18.5	0.014
8	<a href="#">3082 08 08</a>	8	13.5	17	29.5	22.5	0.021
	<a href="#">3082 08 10</a>	10	13.5	19	29	23	0.025
10	<a href="#">3082 10 10</a>	10	16	20	33	26	0.029
	<a href="#">3082 10 12</a>	12	16	20	33	26	0.040
12	<a href="#">3082 12 12</a>	12	19	23	39	31	0.056

Available on request

# Polymer Cartridges for Compressed Air

## 3081 Quick Fitting 45° Elbow

Technical polymer, nickel-plated brass, NBR

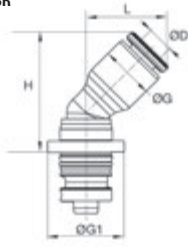

ØD		Cavity	G	G1	H	L	kg
4	<a href="#">3081 04 04</a>	4	9	12.5	19	13	0.004
6	<a href="#">3081 06 06</a>	6	11	12.5	22	14.5	0.006
8	<a href="#">3081 08 08</a>	8	13.5	14.5	26	19	0.011
10	<a href="#">3081 10 10</a>	10	16	19	30	22	0.017
12	<a href="#">3081 12 12</a>	12	19	20	35.5	26	0.031

Available on request

## 3088 Quick Fitting Tee

Technical polymer, nickel-plated brass, NBR

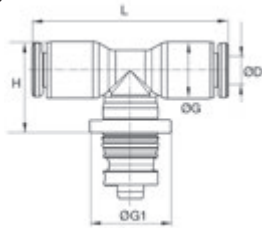

ØD		Cavity	G	G1	H	L	kg
4	<a href="#">3088 04 04</a>	4	9	12.5	14	30	0.005
	<a href="#">3088 04 06</a>	6	8.6	12.5	12.5	29.5	0.006
6	<a href="#">3088 06 06</a>	6	11	12.5	14.5	34	0.007
	<a href="#">3088 06 08</a>	6	10.6	14.5	15	33.5	0.011
8	<a href="#">3088 08 08</a>	8	14	14.5	19	46	0.013
	<a href="#">3088 08 10</a>	8	14	19	19	46	0.023
10	<a href="#">3088 10 10</a>	10	16	19	21	53	0.020
	<a href="#">3088 10 12</a>	10	16	20	21	53	0.031
12	<a href="#">3088 12 12</a>	12	19	20	24	61	0.035

## Cavity Dimensions

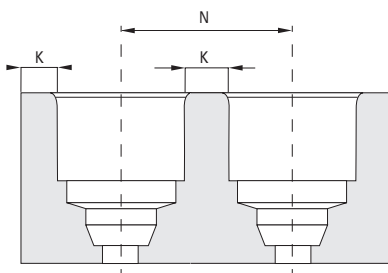
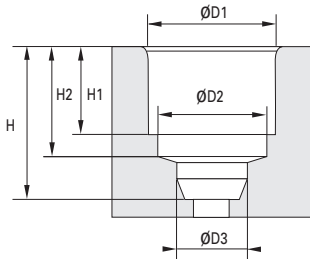

### Carstick® and Quick Fitting Metric

Cavity	ØD3	H	H1	H2
4	4.1	10	6	8.15
6	6.1	12	7.5	9.65
8	8.15	15.5	9.9	12.45
10	10.25	19	11.7	14.35
12	12.17	22	13.9	16.75

### Carstick® Inch

Cavity	ØD3	H	H1	H2
1/8	3.25	9.5	5.3	7.45
5/32*	4.1	10	6	8.15
1/4	6.45	12.5	8	10.15
5/16*	8.15	15.5	9.9	12.45
3/8	9.65	19	11.7	14.35

### Polyamide Cavity

Cavity	ØD1	ØD2	N*	N**	K
4	8.25	7.05	9.8	12.3	1.5
6	10.2	9.15	12.2	12.3	2
8	12.15	10.85	14.2	14.3	2
10	14.8	13.2	16.8	19	2
12	17.5	15.5	20	20.2	2.5

Cavity	ØD1	ØD2	N	K
1/8	7.05	6.02	8.6	1.5
5/32*	8.25	7.05	9.75	1.5
1/4	10.55	9.35	12.6	2
5/16*	12.15	10.85	14.2	2
3/8	14.8	13.1	16.8	2

### Aluminium Cavity

Cavity	ØD1	ØD2	N*	N**	K*	K**
4	8.25	7.5	11.5	12.3	3	1.5
6	10.3	9.15	13.5	12.3	3	2
8	12.2	10.85	15.2	15.2	3	2
10	15.05	13.2	17.1	19	2	2
12	17.5	15.5	20	20.2	2.5	2.5

Cavity	ØD1	ØD2	N	K
1/8	7.1	6.2	8.6	1.5
5/32*	8.25	7.05	11.25	3
1/4	10.6	9.35	12.65	2
5/16*	12.2	10.85	15.2	3
3/8	15.05	13.1	17.1	2

### Brass Cavity

Cavity	ØD1	ØD2	N*	N**	K*	K**
4	8.25	7.05	10.25	12.3	2	1.5
6	10.25	9.1	12.25	12.3	2	2
8	12.2	10.85	14.25	14.3	2	2
10	15.05	13.2	17.1	19	2	2
12	17.65	15.5	20	20.2	2.5	2.5

Cavity	ØD1	ØD2	N	K
1/8	7.1	6.2	8.6	1.5
5/32*	8.25	7.05	10.25	2
1/4	10.6	9.35	12.65	2
5/16*	12.2	10.85	14.25	2
3/8	15.05	13.1	17.1	2

Please consult us for detailed drawings of cavity dimensions and tolerances.

All our dimensions are in millimeters.

\*Carstick® / \*\*Quick Fitting

\*5/32" = 4 mm and 5/16" = 8 mm

# Polymer Cartridges for Fluids and Gases

**6300**

LIQUIfit® Cartridge

Brass, EPDM

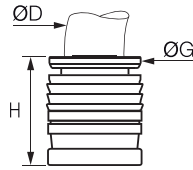

ØD		G	G1	H	L	kg
4	<b>6300 04 00</b>	8	11	10	554	0.002
6	<b>6300 06 00</b>	10	14.5	11.5	629	0.002
8	<b>6300 08 00</b>	13	15	15	794	0.003
10	<b>6300 10 00</b>	15.5	19.5	17	930	0.005
12	<b>6300 12 00</b>	18.5	21	19.5	1038	0.010

50 cartridges per Carstick®



**6300**

LIQUIfit® Cartridge

Brass, EPDM

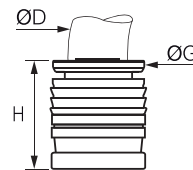

ØD		G	G1	H	L	kg
1/4	<b>6300 56 00</b>	10.5	14.5	12.5	600	0.002
3/8	<b>6300 60 00</b>	15.5	19	17	930	0.005
1/2	<b>6300 62 00</b>	22	25	23	1038	0.011

50 cartridges per Carstick®

5/32" (4 mm) and 5/16" (8 mm) also available.



## LIQUIfit® Cavity Dimensions

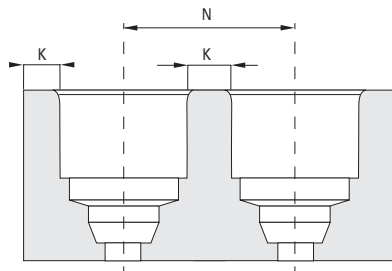
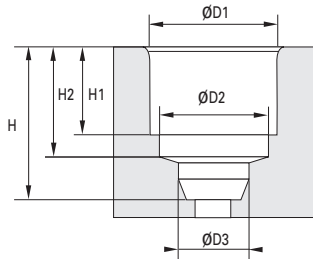

LIQUIfit® Carstick®

Metric

LIQUIfit® Carstick®

Inch

Cavity	ØD3	H	H1	H2
4	4.1	10	6	8.15
6	6.1	12	7.5	9.65
8	8.15	15.5	9.9	12.45
10	10.25	19	11.7	14.35
12	12.17	22	13.9	16.75

Cavity	ØD3	H	H1	H2
1/8	3.25	9.5	5.3	7.45
5/32*	4.1	10	6	8.15
1/4	6.45	12.5	8	10.15
5/16*	8.15	15.5	9.9	12.45
3/8	9.65	19	11.7	14.35

Polyamide Cavity

Cavity	ØD1	ØD2	N	K
4	8.25	7.05	9.8	1.5
6	10.2	9.15	12.2	2
8	12.15	10.85	14.2	2
10	14.8	13.2	16.8	2
12	17.5	15.5	20	2.5

Cavity	ØD1	ØD2	N	K
1/8	7.05	6.02	8.6	1.5
5/32*	8.25	7.05	9.75	1.5
1/4	10.55	9.35	12.6	2
5/16*	12.15	10.85	14.2	2
3/8	14.8	13.1	16.8	2

Aluminium Cavity

Cavity	ØD1	ØD2	N	K
4	8.25	7.5	11.5	3
6	10.3	9.15	13.5	3
8	12.2	10.85	15.2	3
10	15.05	13.2	17.1	2
12	17.5	15.5	20	2.5

Cavity	ØD1	ØD2	N	K
1/8	7.1	6.2	8.6	1.5
5/32*	8.25	7.05	11.25	3
1/4	10.6	9.35	12.65	2
5/16*	12.2	10.85	15.2	3
3/8	15.05	13.1	17.1	2

Brass Cavity

Cavity	ØD1	ØD2	N	K
4	8.25	7.05	10.25	2
6	10.25	9.1	12.25	2
8	12.2	10.85	14.25	2
10	15.05	13.2	17.1	2
12	17.65	15.5	20	2.5

Cavity	ØD1	ØD2	N	K
1/8	7.1	6.2	8.6	1.5
5/32*	8.25	7.05	10.25	2
1/4	10.6	9.35	12.65	2
5/16*	12.2	10.85	14.25	2
3/8	15.05	13.1	17.1	2

Please consult us for detailed drawings of cavity dimensions and tolerances.

All our dimensions are in millimeters.

\*5/32" = 4 mm and 5/16" = 8 mm





# Metal Cartridges

For full **compatibility** with **many fluids** and severe conditions (**+150°C**), Parker Legris has developed two types of patented cartridges. Using our metal cartridges allows for **optimisation of installation configurations** and for the FTL, the possibility of removal.

## Product Advantages

- LF Cartridges**
  - LF 3600** All the advantages of the LF 3600, LF 3800 and LF 3900 fittings applied to cartridge technology
  - LF 3800** All-metal product to provide the greatest mechanical strength and chemical resistance
  - LF 3900**
    - Resistant at high temperatures (+150°C)
    - Can be installed in either polymer or metal housings
- FTL Cartridge**
  - Possibility to have several tubing diameters in the same cavity
  - Visible retention and sealing system, can be disassembled using the dedicated tool



- Applications**
- Robotics
  - Automotive Process
  - Pneumatics
  - Semi-Conductors
  - Refrigeration
  - Packaging
  - Vacuum

## Technical Characteristics

LF 3600, LF 3800, LF 3900		FTL Cartridge	
<b>Compatible Fluids</b>	Fluids: see corresponding chapters	<b>Compatible Fluids</b>	Compressed air
<b>Working Pressure</b>	Vacuum to 30 bar	<b>Working Pressure</b>	0.01 to 16 bar
<b>Working Temperature</b>	-20°C to +150°C	<b>Working Temperature</b>	-25°C to +80°C
<b>Component Materials</b>	See corresponding chapters	<b>Component Materials</b>	Body: brass Release button: technical polymer Gripping ring: stainless steel Seals: NBR

### Regulations

- LF 3600, LF 3800, LF 3900**  
**DI:** 97/23/CE (PED)  
**RG:** 21 CFR (FDA)  
**RG:** 1935/2004/CE  
 (minimum flow 0.02 l/hr)  
**DI:** 2011/65/CE (RoHS)  
**USDA NSF H1:** grease  
**ASTM B733-04:** self-catalytic nickel coating  
**DI:** 94/9/CE (ATEX)
- FTL**  
**DI:** 97/23/CE (PED)  
**DI:** 2011/65/CE (RoHS)

Reliable performance is dependent upon the type of fluid conveyed, component materials and tubing being used. Guaranteed for use with a vacuum of 755 mm Hg (99% vacuum).

# Metal Cartridges for Fluids and Gases

## 3600

### One-Piece Cartridge



FDA chemical nickel-plated brass, FKM

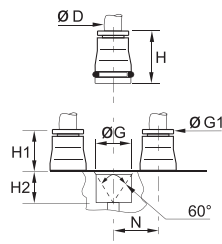

ØD		G	G1	H	H1	H2	N	kg
4	<a href="#">3600 04 00</a>	9.8	8	17	8.5	8.5	11	0.006
6	<a href="#">3600 06 00</a>	12.1	10	19	10.5	8.5	13.5	0.009
8	<a href="#">3600 08 00</a>	14.8	13	21	12.5	8.5	16	0.012
10	<a href="#">3600 10 00</a>	17.5	15	24.5	14	10.5	20	0.019
12	<a href="#">3600 12 00</a>	20	17	25	14.5	10.5	22.5	0.023
14	<a href="#">3600 14 00</a>	22	20	28.5	16.5	12	25	0.031

## 3800/3900

### One-Piece Cartridge



Stainless steel 316L, FKM

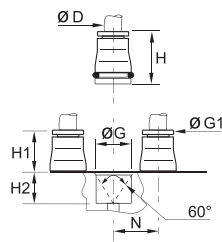

ØD			G	G1	H	H1	H2	N	kg
4	<a href="#">3800 04 00</a>	<a href="#">3900 04 00</a>	9.8	8	17	8.5	8.5	11	0.006
6	<a href="#">3800 06 00</a>	<a href="#">3900 06 00</a>	12.1	10	19	10.5	8.5	13.5	0.008
8	<a href="#">3800 08 00</a>	<a href="#">3900 08 00</a>	14.8	13	21	12.5	8.5	16	0.012
10	<a href="#">3800 10 00</a>	<a href="#">3900 10 00</a>	17.5	15	24.5	14	10.5	20	0.019
12	<a href="#">3800 12 00</a>	<a href="#">3900 12 00</a>	20	17	25	14.5	10.5	22.5	0.022

3800: collet in stainless steel 303

3900: collet in stainless steel 316L

Cavity dimensions are available in chapter 2.

## FTL

### Cartridge

Brass, NBR

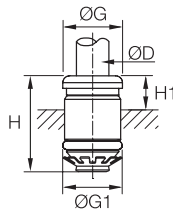

ØD	Cavity		G	G1	H	H1	H2	kg
4	4	<a href="#">FTL4</a>	8	8	14.5	4.5	7.5	0.003
4	6	<a href="#">FTL6-4</a>	8	10	17	4.5	9.5	0.003
6	6	<a href="#">FTL6</a>	10.5	10	17	4.5	9.5	0.004
4	8	<a href="#">FTL8-4</a>	8	12	17.5	5	10.5	0.008
6	8	<a href="#">FTL8-6</a>	10.5	12	18	5.5	11	0.008
8	8	<a href="#">FTL8</a>	13.5	12	19	6.5	12	0.005

\* Can be mounted in a short hole with extremely close porting

## TLT

### Dismounting Tool

Nickel-plated brass

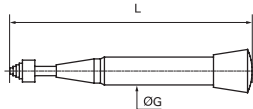

	G	L	kg
<a href="#">TLT</a>	28	156	0.235

\* Can be mounted in a short hole with extremely close porting

## Cavity Dimensions

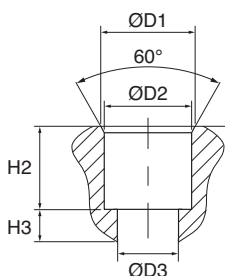

### FTL Cartridge

Cavity	ØD1	ØD2	ØD3	H2	H3
4	9	8	5.5	9	1.5
6	11	10	8	11	1.5
8	13	12	8.5	11.5	1.5
4C*	9	8	5.5	6	1.5
6C*	11	10	8	6	1.5
8C*	13	12	8.5	6	1.5

\*Can be mounted in a short hole with extremely close porting

# Customised Solutions

Parker Legris has made **the development of customised products** one of its specialities. These dedicated products provide our customers with a **technical and economic solution** which fully meets their needs.

## Customised Solution Development Process

- 1. Define the Function Parameters**

Specify the pressure, temperature, environment, fluids, materials and product function you need.

Estimate the quantity requirements.

Our product engineers are available to help you refine your requirements.
- 2. Send Your Request to our Technical Department**

Complete the online request form at [www.parkerlegris.com](http://www.parkerlegris.com), "Special Products".

Specify your quantities, technical and commercial requirements.
- 3. Request Analysis**

We assess the feasibility of the product based on the information you have sent us.

We carry out a technical study and produce drawings (prototypes and testing as necessary).
- 4. Parker Legris Proposes the Customised Solution**

We submit the optimum technical and commercial proposal.

If our proposal is accepted, we launch the production process.
- 5. Serial Production**

We will continually update you as to the status of your order and delivery date.

# Customised Products

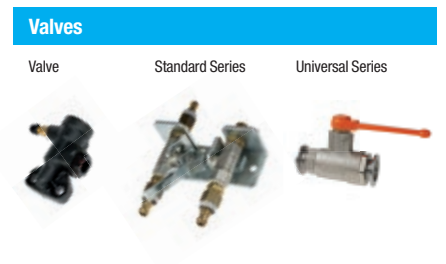
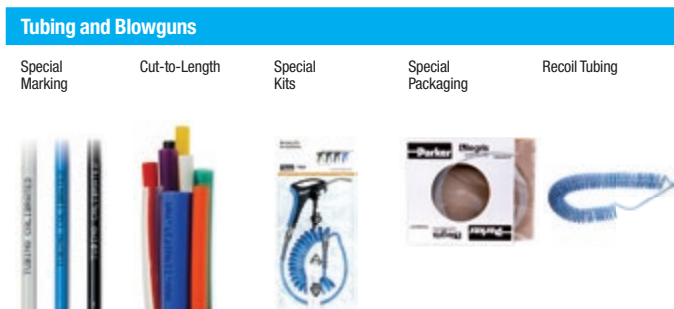
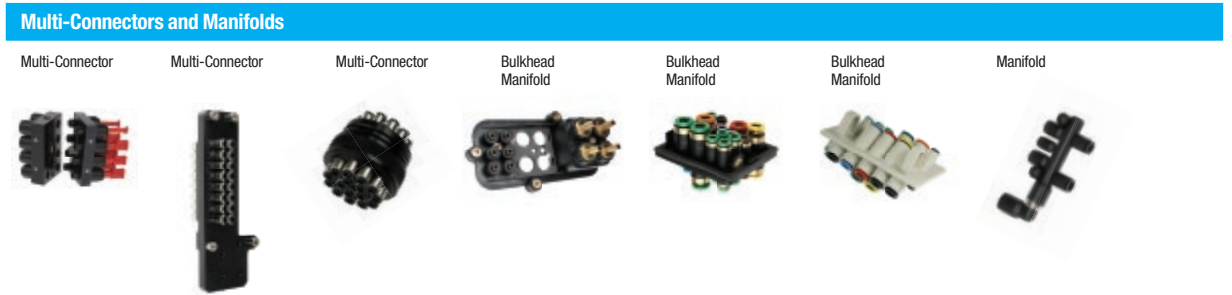

## Skilled and Dedicated People Provide You with the Best Solution

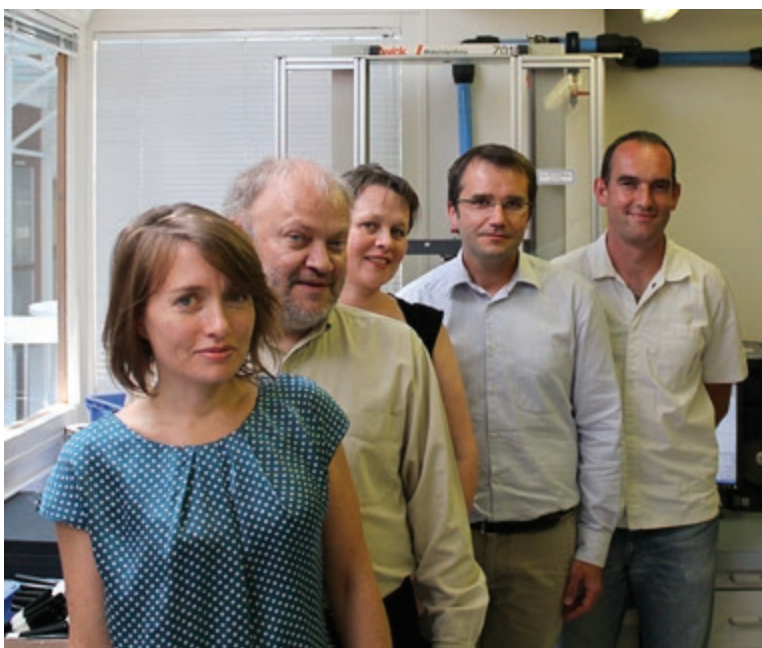

**More than 40 years' experience** in the design of push-in fittings also means more than 40 years spent in producing customised solutions for our customers.

We have a team of motivated and experienced engineers skilled in using the latest design tools: calculation and digital simulation tools, CAD, rheology (plastic injection modelling), quick prototyping and performance measuring in the laboratory.



# Customised Fittings

To meet your needs, we can re-engineer the design of our fittings.

To complement our wide range of fittings, we can offer customised products.

Longer threads, different types of seal, special grease, specific cleaning processes, colours, packaging, etc. are all parameters which we can easily modify.



**Low Temperature Carstick®**  
Resistant at -40°C



**Filter Fittings for Medical and Clean Room Applications**  
Designed specifically for the filtration of air and gas  
Can be made available with cleanliness specifications meeting requirements for medical processes and clean rooms



**Metal Cartridges**  
Cartridges adapted to the client's dimensional and environmental requirements  
Combination of the patented Carstick® system (seal protection) and LF 3600 performance levels



**Multi-Component Stud Cartridges**  
Direct installation into a cavity with no thread  
Can be custom-designed: seal, release button, etc.



**Built-In Cartridge**  
Designed to be extremely compact, this cartridge can be built right into a cavity with no thread, and can also be disassembled



**Fitting for Life Sciences & Clean Rooms**  
Specific gripping feature, cleanliness, oxygen-compatible grease  
Reinforced leak testing  
Special packaging



**Fitting with Silencer, Two-in-One**  
Meeting requirements for saving space, this lightweight component includes a push-in connection as well as a silencer function



**Fitting for the Transmission of Deionised Cooling Water in Frequency Inverters**  
Water-resistant materials  
Stainless steel threads  
Special seals



#### 150°C Stud Fitting

Developed for use in steam circuits of coffee machines  
 Extreme pressure and temperature resistance  
 Fully compatible with drinking water circuits



#### Fitting for the Transmission of Water in Ceiling-Mounted Air Conditioning Systems

Brass body  
 Double seal  
 Crimped to hose



#### Orifice Fitting

Allows accurate flow regulation  
 Minimum orifice diameter: 0.5 mm



#### Safety Standpipe Fitting

Perfect tear resistance  
 Designed for applications with extremely high cadences



#### Non-Return Valve

Developed for systems carrying breathable air  
 Low cracking threshold  
 Oxygen-compatible grease, cleanliness



#### Compact Flow Regulator with Recessed Screw and FKM Seals

Improved external chemical resistance  
 Custom logo



#### Multi-Connector

Allows disconnection of up to 16 tubes in a single operation  
 Compact design suitable for the operating environment



#### Polymer Body with Integrated Fittings

For connection of pneumatic lines between the truck cab and chassis



#### Polymer Manifold

Reinforced integrated connections  
 Dedicated to the distribution of compressed air for truck auxiliary systems e.g. cab seat, air horn, gauges...



# Customised Tubing and Blowguns

**We can adapt the formulation of polymers and customise tubing or blowguns to suit your requirements.**

We can offer custom modifications such as: special additives and materials, non-standard diameters, customised marking, specific packaging, custom colours, custom tube cutting, pre-formed tubing, packaged solutions (tubes + fittings or couplers, blowgun kits).



Tube marked with customer's name  
Tubes cut to specific lengths



Upon request, Parker Legris can propose any type of coiled tubing  
All material available for standard requests can be adapted for recoil tubing



Marked with the customer's logo and part number  
In lengths of 5 m, 10 m, 25 m, 50 m and 100 m, depending on the tube material  
For flexible or semi-rigid tubing  
Optimised tube packaging  
Easy identification of the tube type  
Integrated reel for easy handling



Marked with the customer's logo and part number  
Up to 1000 m lengths  
Immediate identification of the tube for easy handling  
Suitable for workshop hose reels



Blowgun customised in customer's colours  
Specific logo  
Customised packaging



Production of a "tube + coupler + blowgun" assembly in dedicated and customised packaging

# Customised Valves

Over and above our range of standard valves, Parker Legris can supply application-specific valves adapted to our customers' environment.

We offer custom modifications such as: longer threads, different types of seal, special grease, lever options, specific cleaning process, materials and surface treatments, assemblies, etc.



## Transport Valve

Mounted on the wheel rims of armoured vehicles  
For managing tyre pressures through an integrated inflation valve



## Auto-Process Valve

Designed to simultaneously control both the inlet and outlet of a cooling line  
Also allows one of the lines to be closed independently



## Valve for Breathable Air

Dedicated to the transmission of oxygen-enriched air in hospital networks  
Special seals, cleanliness, specific grease, very high reliability





# Technical Tubing and Hose

**Flexible Calibrated Tubing**

**Calibrated Multi-Tubing**

**Recoil Tubing and Hose**

**Calibrated Braided Hose**

**Accessories**







# Technical Tubing and Hose

## PA Tubing

(P. 3-10)



**Fluids:** Compressed air, industrial fluids

**Materials:**

- 2 polyamide grades (semi-rigid and rigid)
- 7 colours

**Pressure:** 58 bar

**Temperature:** -40°C to +100°C

**O.D. metric:** 3 mm to 16 mm

**O.D. inch:** on request

## Fireproof High Resistance PA Tubing

(P. 3-14)

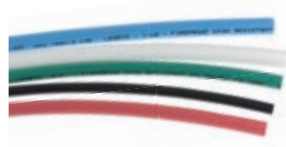

**Fluids:** compressed air, coolants, lubricants

**Materials:**

- Polyamide with flame retardant additive
- 5 colours

**Pressure:** 50 bar

**Temperature:** -50°C to +100°C

**O.D. metric:** 4 mm to 12 mm

## Anti-Spark PA or PU Tubing, with or without PVC Sheath

(P. 3-16 & 24)



**Fluids :** compressed air, coolants, industrial fluids

**Materials :**

- Semi-rigid polyamide with PVC sheath
- Polyurethane ether with PVC sheath
- Single layer polyurethane ether
- 4 colours

**Pressure:** 36 bar max.

**Temperature:** -20°C to +80°C

**O.D. metric:** 4 mm to 14 mm

## PU Tubing

(P. 3-18)



**Fluids:** compressed air and food industry fluids ("crystal")

**Materials:**

- Polyurethane ester or ether
- Polyurethane food-grade "crystal"
- 7 colours

**Pressure:** 12 bar

**Temperature:** -20°C to +70°C

**O.D. metric:** 3 mm to 16 mm

**O.D. inch:** on request

## Antistatic PU Tubing

(P. 3-22)



**Fluids:** compressed air

**Materials:**

- Polyurethane with conductive particles
- Black (10<sup>2</sup> Ω.m)

**Pressure:** 10 bar

**Temperature:** -20°C to +70°C

**O.D. metric:** 3 mm to 12 mm

## PE Tubing

(P. 3-26)



**Fluids:** many fluids

**Materials:**

- Low density polyethylene
- 50% reticulated polyethylene, food-grade
- 7 colours

**Pressure:** 20 bar

**Temperature:** -40°C to +95°C

**O.D. metric:** 4 mm to 16 mm

**O.D. inch:** 1/8" to 1/2"

## FEP Tubing

(P. 3-28)



**Fluids:** many fluids

**Materials:**

- Fluoropolymer: fluorinated ethylene propylene, food-grade
- Transparent

**Pressure:** 28 bar

**Temperature:** -40°C to +150°C

**O.D. metric:** 4 mm to 12 mm

## PFA Tubing

(P. 3-30)



**Fluids:** many fluids

**Materials:**

- 3 grades of perfluoroalkoxy
- High purity food-grade, clear
- Standard food-grade, 3 "crystal" colours
- Antistatic (0.2 Ω.m), black

**Pressure:** 36 bar

**Temperature:** -196°C to +260°C

**O.D. metric:** 4 mm to 12 mm

## PA Multi-Tubing

(P. 3-32)



**Fluids:** compressed air, industrial fluids

**Materials:**

- Semi-rigid polyamide with PVC sheath
- 6 colours

**Pressure:** 24 bar

**Temperature:** -40°C to +80°C

**O.D. metric:** 4 mm to 8 mm

# Technical Tubing and Hose

## Twin PU Tubing

(P. 3-32)



**Fluids:** compressed air

**Materials:**

- Polyurethane ester
- 1 to 2 colours

**Pressure:** 14 bar

**Temperature:** -20°C to +70°C

**O.D. metric:** 4 mm to 8 mm

## Recoil PA Tubing

(P. 3-34)



**Fluids:** compressed air, industrial fluids

**Materials:**

- Semi-rigid polyamide
- 2 colours
- Recoil tubing with fittings

**Pressure:** 20 bar

**Temperature:** -20°C to +80°C

**O.D. metric:** 6 mm and 8 mm

## Recoil PU Tubing

(P. 3-36)



**Fluids:** compressed air

**Materials:**

- Polyurethane ester or ether
- 3 colours
- With or without fittings

**Pressure:** 10 bar

**Temperature:** -20°C to +70°C

**O.D. metric:** 4 mm to 12 mm

**I.D. inch:** 3/8" and 19/32"

## Braided PU Recoil Hose

(P. 3-40)



**Fluids:** compressed air, industrial fluids

**Materials:**

- Translucent blue polyurethane, reinforced with a polyester braid
- Assembled with threaded fittings

**Pressure:** 15 bar

**Temperature:** -40°C to +75°C

**I.D. inch:** 1/4" and 5/16"

## Braided PVC Hose

(P. 3-42)



**Fluids:** compressed air, non-corrosive or alimentary fluids (translucent PVC)

**Materials:**

- Polyvinyl chloride with braided polyester
- Translucent (food-grade) or blue (industrial)

**Pressure:** 15 bar

**Temperature:** -25°C to +70°C

**I.D. metric:** 4 mm to 19 mm

## Self-Fastening NBR Hose

(P. 3-44)



**Fluids:** compressed air, coolants

**Materials:**

- Nitrile butadiene rubber reinforced with a polyamide braid
- 4 colours

**Pressure:** 16 bar

**Temperature:** -20°C to +100°C

**I.D. inch:** 1/4" to 3/4"

# Technical Tubing and Hose Range

## Flexible Calibrated Tubing

### Polyamide Tubing

#### Semi-Rigid PA



**1025P**  
**1100P**  
**2005P**  
**2010P**  
Page 3-11

#### Rigid PA



**1025L**  
Page 3-12

#### Fireproof PA



**1100P..R**  
Page 3-15

#### Anti-Spark PA with PVC Sheath



**1025P..V**  
**1100P..V**  
Page 3-17

### Polyurethane Tubing

#### PU Ester



**1025U**  
**1100U**  
**2003U**  
**2005U**  
**2010U**  
Page 3-19

#### PU Ether PU Ether Food-Grade "Crystal"



**1025U..R**  
**1100U..R**  
**2003U..R**  
**2005U..R**  
**2010U..R**  
Page 3-20

#### Antistatic PU



**1025U..A**  
**1100U..A**  
Page 3-23

#### PU Ether, Anti-Spark, Single Layer PU Ether, Anti-Spark with PVC Sheath



**1025U..V**  
**1100U..V**  
Page 3-25  
**1025U..K**  
**1100U..K**  
Page 3-25

### Polyethylene Tubing

#### Advanced PE



**1015Y..F**  
**1030Y..F**  
**1075Y..F**  
**1096Y..F**  
**1098Y..F**  
**1099Y..F**  
Page 3-27

#### Low Density PE



**1100Y**  
Page 3-27

### Fluoropolymer Tubing

#### FEP



**1005T**  
**1025T**  
Page 3-29

#### PFA



**1010T..P**  
**1050T..P**  
**1100T..P**  
Page 3-31

#### Antistatic PFA



**1010T..A**  
**1050T..A**  
Page 3-31

## Calibrated Multi-Tubing

### Polyamide Tubing with PVC Sheath

#### Semi-Rigid PA



**1010P..M**  
**1050P..M**  
Page 3-33

### Twin Polyurethane Tubing

#### Twin PU Ester



**1420U**  
Page 3-33

# Technical Tubing and Hose Range

## Calibrated Recoil Tubing

### Semi-Rigid Polyamide

Assembled with Fittings



**1470P**  
**1471P**  
**1472P**  
Page 3-35

### Polyurethane Ester and Ether Tubing

Assembled with Fittings,  
Metallic Spring Guard

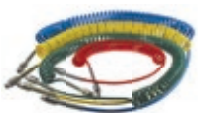

**1470U**  
**1471U**  
**1472U**  
Page 3-37

Assembled with Fittings,  
Plastic Spring Guard



**1445U..R**  
**1441U..R**  
**1442U..R**  
**1447U..R**  
Page 3-38

Coiled without Fittings



**1460U**  
**1461U**  
**1462U**  
Page 3-37

### Braided Polyurethane Hose

Assembled with Fittings,  
Plastic Spring Guard



**1445U..E**  
**1442U..E**  
**1447U..E**  
Page 3-41

## Calibrated Braided Hose

Clear Food-Grade PVC



**1025V**  
**1050V**  
Page 3-43

Blue PVC



**1025V..C**  
**1050V..C**  
Page 3-43

Self-Fastening NBR



**1040H**  
**1080H**  
**1100H**  
Page 3-45

## Accessories

**0694**  
Page 3-46



**0695**  
Page 3-46



**3000 71 11**  
Page 3-46



**3000 71**  
Page 3-46



**6000 71**  
Page 3-46



**0127**  
Page 3-47



**1827**  
Page 3-47



**Clip**  
Page 3-47



**0697**  
Page 3-47



# Packaging for Technical Tubing and Hose

## Tubepack®

- 5 m, 10 m, 25 m and 100 m lengths
- For polyamide, polyurethane, fluoropolymer, polyethylene and anti-spark tubing
- Optimisation of tubing storage
- Immediate identification of the type of tubing
- Integrated winder for easy handling



## Drums

- Up to 1000 m long
- For polyamide, polyurethane, fluoropolymer tubing, etc.
- Immediate identification of the tubing for easy handling
- Adapted to workshop reels



## Reels

- Up to 100 m
- Supplied with protective plastic film
- For braided tubing, special tubing (e.g. multi-tubing)



## Plastic Bags

- Ideal for merchandising
- Promotional tools
- Recoil tubing or tubing cut to the required length



## Tube Marking

- Length indicated every metre:
  - time saved when cutting to exact length
  - remaining quantity is immediately identifiable (PA and PU)
- Custom marking upon request (marking, fluid identification, customer part number...)
- Traceability with marking of manufacturing batch



## How to Read the Graphs

- In the graphs in this chapter, each curve represents the acceptable maximum pressure at a given temperature, by diameter.
- Technical characteristics of Parker Legris tubing depend on the type of connection used.
- The vacuum capability of all tubing is 755 mm Hg (99% vacuum).

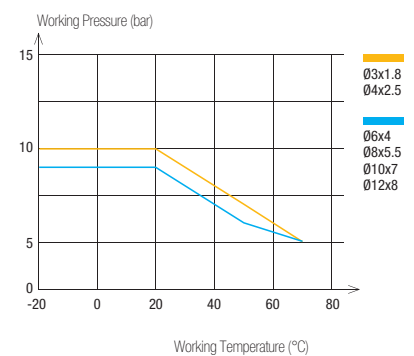



# Product Codes of Parker Legris Tubing and Hose

## Material

- H** = Self-Fastening NBR
- L** = Rigid Polyamide
- P** = Semi-Rigid Polyamide
- T** = Fluoropolymer
- U** = Polyurethane
- V** = PVC
- Y** = Polyethylene

## Type of Tubing

- P..**A** = Antistatic PA
- P..**R** = Fireproof PA
- P..**V** = Anti-Spark PA with PVC Sheath
- T..**A** = Antistatic PFA
- T..**P** = PFA
- U..**A** = Antistatic PU
- U..**K** = Anti-Spark Single Layer PU
- U..**R** = PU Ether
- U..**V** = Anti-Spark PU with PVC Sheath
- Y..**F** = Advanced PE (LIQUIfit®)

**2010 P 04 R 00 27**

### Packaging Code

**1** = Tubepack® or LIQUIfit® Drum

### Length

**015** = 150 m  
**020** = 20 m  
**025** = 25 m  
**030** = 300 m  
**040** = 40 m  
**075** = 75 m  
**080** = 80 m  
**100** = 100 m

### O.D. Code

**03** = 3 mm  
**04** = 4 mm  
**06** = 6 mm  
**08** = 8 mm  
 .../...  
 1/4 = 56 mm  
 .../...

### Colour

**00** = ◯ clear  
**01** = ● black  
**02** = ● green  
**03** = ● red  
**04** = ● blue  
**05** = ● yellow  
**06** = ● grey  
**07** = ● orange  
**08** = ◯ crystal clear  
**09** = ● purple  
**10** = ◯ white  
**12** = ● crystal green  
**13** = ● crystal red  
**14** = ● crystal blue  
**17** = ● crystal orange

### Special I.D.

**18** = 1.8 mm  
**27** = 2.7 mm  
**33** = 3.3 mm  
**75** = 7.5 mm  
**95** = 9.5 mm

**2** = Long Length on Drum

**003** = 300 m  
**005** = 500 m  
**010** = 1000 m

**10** = 10 mm  
**04** = 4 mm  
**06** = 6 mm  
**08** = 8 mm  
**10** = 10 mm  
**04** = 4 mm  
**06** = 6 mm

## Tube Cutting to the Required Length

- Upon special request, customised cutting of the semi-rigid tubing (PA, PU, PE, FEP, PFA, ...)
- Cutting length from 30 mm to 14 m (+/- 2 mm precision)
- Marking upon request, in white or red
- Packaging according to customer requirements (bags/boxes/etc, ...)





# PA Tubing

**Tried-and-tested** for industrial or vehicle applications, PA tubing guarantees **excellent durability** due to its stable long-term mechanical properties. Parker Legris' special grade of semi-rigid polyamide is manufactured according to our **Eco-Design** approach for higher performance.

## Product Advantages

### Tried-&-Tested Material

- Good chemical and humidity resistance
- Excellent material stability (mechanical and chemical)
- Continuous calibration during production for excellent reliability
- Two material grades: rigid and semi-rigid
- Bio-based semi-rigid material

### Versatility & Performance

- Wide range of working pressure and temperature
- Good vibration absorption
- Abrasion-resistant
- Remaining length marking
- Large choice of colours to facilitate circuit identification
- Silicone-free



Packaging  
Tooling  
Compressed Air  
Motion Technologies  
Robotics  
Industrial Machinery

Applications

## Technical Characteristics

Tubing	Semi-Rigid PA	Rigid PA
Compatible Fluids	Compressed air, other fluids	Compressed air, lubricants, other fluids
Working Pressure	Vacuum to 50 bar	Vacuum to 58 bar
Working Temperature	-40°C to +100°C	-40°C to +80°C
Component Materials	Bio-based polyamide (68 shore D)	Polyamide (65 shore D)

### Regulations

#### Industrial

DI: 2002/95/EC (RoHS), 2011/65/EC  
DI: 97/23/EC (PED)  
RG: 1907/2006 (REACH)

#### Transportation

Chemical performance and resistance tested according to  
DIN 74324 -1 / DIN 73378 / ISO 7628

### Packaging

Tube pack: 25 m, 100 m  
Drum: 500 m, 1000 m

Reliable performance is dependent upon the type of fluid conveyed and fittings being used. Use is guaranteed with a vacuum of 755 mm Hg (99% vacuum).

### Performance of PA Tubing

#### Semi-Rigid

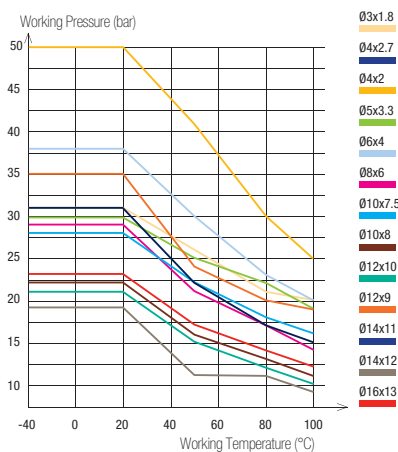

#### Rigid

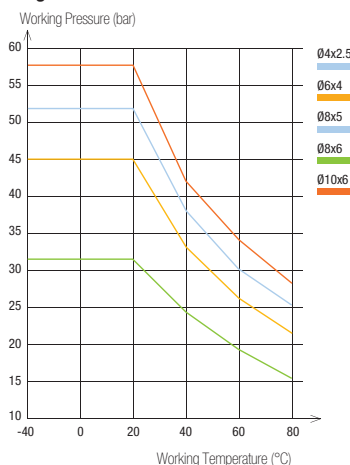









Tube O.D.	Tube O.D. Tolerance
3 to 5 mm	+0.05 / -0.08
6 to 16 mm	+0.05 / -0.10

Connected to Parker Legris push-in fittings, the calibration of Parker Legris tubing ensures perfect sealing in accordance with NF E49-100.

**1025P**

## Semi-Rigid Polyamide (PA) Tubing

Tubepack® 25 m









Ø ext. (mm)	Ø int. (mm)		 clear							kg
3	1.8	6	1025P03 00 18				1025P03 04 18			0.200
4	2	10	1025P04 00	1025P04 01	1025P04 02	1025P04 03	1025P04 04	1025P04 05	1025P04 06	0.318
	2.7	10	1025P04 00 27	1025P04 01 27	1025P04 02 27	1025P04 03 27	1025P04 04 27	1025P04 05 27	1025P04 06 27	0.254
5	3.3	15	1025P05 00 33	1025P05 01 33			1025P05 04 33			0.420
6	4	15	1025P06 00	1025P06 01	1025P06 02	1025P06 03	1025P06 04	1025P06 05	1025P06 06	0.535
8	6	25	1025P08 00	1025P08 01	1025P08 02	1025P08 03	1025P08 04	1025P08 05	1025P08 06	0.748
10	7.5	42	1025P10 00 75	1025P10 01 75			1025P10 04 75			1.135
	8	50	1025P10 00	1025P10 01	1025P10 02	1025P10 03	1025P10 04	1025P10 05	1025P10 06	0.989
12	9	47	1025P12 00 09	1025P12 01 09			1025P12 04 09			1.769
	10	90	1025P12 00	1025P12 01			1025P12 04	1025P12 05		1.345
14	11	80	1025P14 00 11	1025P14 01 11			1025P14 04 11			2.226
	12	116	1025P14 00	1025P14 01			1025P14 04			1.734
16	13	90	1025P16 00 13	1025P16 01 13	1025P16 02 13	1025P16 03 13	1025P16 04 13			2.500

Inch version tubing available upon request

**1100P**

## Semi-Rigid Polyamide (PA) Tubing

Tubepack® 100 m









Ø ext. (mm)	Ø int. (mm)		 clear							kg
4	2	10	1100P04 00	1100P04 01	1100P04 02	1100P04 03	1100P04 04	1100P04 05	1100P04 06	1.152
	2.7	10	1100P04 00 27	1100P04 01 27	1100P04 02 27	1100P04 03 27	1100P04 04 27	1100P04 05 27	1100P04 06 27	0.893
5	3.3	15	1100P05 00 33	1100P05 01 33			1100P05 04 33			1.274
6	4	15	1100P06 00	1100P06 01	1100P06 02	1100P06 03	1100P06 04	1100P06 05	1100P06 06	1.799
8	6	25	1100P08 00	1100P08 01	1100P08 02	1100P08 03	1100P08 04	1100P08 05	1100P08 06	2.898
10	7.5	42	1100P10 00 75	1100P10 01 75			1100P10 04 75			4.400
	8	50	1100P10 00	1100P10 01	1100P10 02	1100P10 03	1100P10 04	1100P10 05		3.667
12	9	47	1100P12 00 09	1100P12 01 09			1100P12 04 09			5.600
	10	90	1100P12 00	1100P12 01			1100P12 04		1100P12 06	5.052
14	11	80	1100P14 00 11	1100P14 01 11			1100P14 04 11			5.200
	12	116	1100P14 00	1100P14 01			1100P14 04			4.800
16	13	90	1100P16 00 13	1100P16 01 13	1100P16 02 13	1100P16 03 13	1100P16 04 13			7.800

Inch versions: also available

**2005P**

## Semi-Rigid Polyamide (PA) Tubing









Drum 500 m

Ø ext. (mm)	Ø int. (mm)		 clear							kg
8	6	25	2005P08 00	2005P08 01	2005P08 02	2005P08 03	2005P08 04	2005P08 05	2005P08 06	12.100
10	8	50	2005P10 00	2005P10 01	2005P10 02	2005P10 03	2005P10 04	2005P10 05		15.600

**2010P**

## Semi-Rigid Polyamide (PA) Tubing

Drum 1000 m

Ø ext. (mm)	Ø int. (mm)		 clear							kg
4	2.7	10	2010P04 00 27	2010P04 01 27	2010P04 02 27	2010P04 03 27	2010P04 04 27	2010P04 05 27	2010P04 06 27	7.630
6	4	15	2010P06 00	2010P06 01	2010P06 02	2010P06 03	2010P06 04	2010P06 05	2010P06 06	16.600

**Tube Cutting to the Required Length**

- Upon special request, customised cutting of the semi-rigid tubing (PA, PU, PE, FEP, PFA, ...)
- Cutting length from 30 mm to 14 m (+/- 2 mm precision)
- Marking upon request, in white or red
- Packaging according to customer requirements (bags/boxes/etc, ...)





# PA Tubing

## 1025L

Rigid Polyamide (PA) Tubing

Tubepack® 25 m

Ø ext. (mm)	Ø int. (mm)	 R		kg
4	2.5	35	<a href="#">1025L04 01 25</a>	0.190
6	4	45	<a href="#">1025L06 01</a>	0.400
8	5	70	<a href="#">1025L08 01 05</a>	0.760
	6	65	<a href="#">1025L08 01</a>	0.760
10	6	85	<a href="#">1025L10 01 06</a>	1.330

PA tubing can be connected to various fittings shown throughout this catalogue.

### Tubing

#### Semi-Rigid PA



#### Rigid PA



### Push-In Fittings

[LF 3000®](#) P. 1-4



[LF 3600](#) P. 1-95



[LF 3800/LF 3900](#) P. 1-113



[LF 6100](#) P. 1-107



### Compression Fittings

[Brass](#) P. 5-5



[Stainless Steel](#) P. 5-31



[Ferrules](#) P. 5-5





Flexible Calibrated Tubing

Technical Tubing  
and Hose



# Fireproof High Resistance PA Tubing

This **single layer fireproof** tubing not only combines excellent resistance to pressure, temperature and flame, but also guarantees **non-toxic smoke** resulting from burn-off. This tubing eliminates the need for a stripping tool, thus preventing the risk of tube damage prior to connection.

## Product Advantages

### Safety for On-Board Railway Equipment

- Designed for on-board equipment
- Excellent flame resistance: self-extinguishing
- Very little smoke generation
- Non-toxic combustion gases
- UV-resistant
- Extremely resistant to high pressure and temperature

### Innovative Single-Layer Solution

- Developed for demanding industrial applications
- Excellent spark resistance
- Economical alternative to PA tubing with PVC sheath
- Combines technical advantages of rigid and semi-rigid PA tubing
- 5 colours available
- Flow direction marking
- Silicone-free



**Applications**

- Railway
- Air Horns
- Industrial Machinery
- Pneumatic Doors
- Step-Units
- Centralised Lubrication
- Welding

## Technical Characteristics

<b>Compatible Fluids</b>	Compressed air, lubricants Other fluids: please consult us
<b>Working Pressure</b>	Vacuum to 50 bar
<b>Working Temperature</b>	-40°C to +100°C
<b>Component Materials</b>	Polyamide (63 shore D)

### Regulations

#### Railway

Pr EN 45545-2: HL3, R22, R24, R25  
NF F16101: I3 F2,  
DIN 5510-2: S4, SR2, ST2  
ISO 4892

#### Industrial

DI: 97/23/EC (PED)  
DI: 2002/95/EC (RoHS), 2011/65/EC  
RG: 1907/2006/EC (REACH)  
UL94 V-0 (Fire resistance)

Reliable performance is dependent upon the type of fluid conveyed and fittings being used. Use is guaranteed with a vacuum of 755 mm Hg (99% vacuum).

### Performance of Fireproof High Resistance PA Tubing

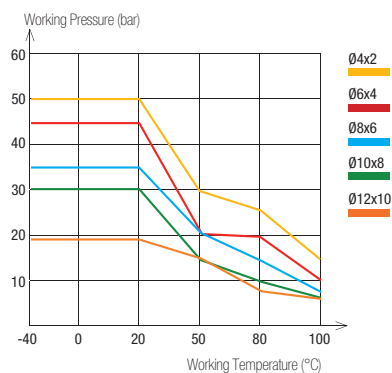

Tube O.D.	Tube O.D. Tolerance
4 mm	+0.05 / -0.08
6 to 12 mm	+0.05 / -0.10

**Packaging**  
Tubepack\*: 100 m





Connected to Parker Legris push-in fittings, the calibration of PA tubing ensures perfect sealing based on NF E49-100.

To calculate burst pressure, the values in this graph should be multiplied by 3.

# 1100P..R

## Fireproof High Resistant Polyamide (PA) Tubing

Tubepack® 100 m

Ø ext. (mm)	Ø int. (mm)	 R	 clear			kg
4	2	17	<a href="#">1100P04R00</a>	<a href="#">1100P04R01</a>	<a href="#">1100P04R04</a>	1.308
6	4	29	<a href="#">1100P06R00</a>	<a href="#">1100P06R01</a>	<a href="#">1100P06R04</a>	1.308
8	6	40	<a href="#">1100P08R00</a>	<a href="#">1100P08R01</a>	<a href="#">1100P08R04</a>	2.122
10	8	77	<a href="#">1100P10R00</a>	<a href="#">1100P10R01</a>	<a href="#">1100P10R04</a>	2.725
12	10	92	<a href="#">1100P12R00</a>	<a href="#">1100P12R01</a>	<a href="#">1100P12R04</a>	3.716

Other colours available on request with a minimum order quantity: for diameters 4 to 6 mm, 1000 m; for 8 mm, 500 m; for diameters 10 to 12 mm, 300 m.

Flexible Calibrated Tubing

Technical Tubing and Hose

### Related Products

Fireproof high resistance tubing can be connected to various fittings presented in Chapters 1 and 5.

#### Push-In Fittings

[LF 3000®](#)  
P. 1-4

[LF 3600](#)  
P. 1-95

[LF 3800/LF 3900](#)  
P. 1-113

[LF 6100](#)  
P. 1-107



#### Compression Fittings

[Brass](#)  
P. 5-5

[Brass Tube Support](#)  
P. 5-5



# Anti-Spark PA Tubing with PVC Sheath

A range of **flame and spark-resistant** PA tubing with superior resistance to impact and abrasion, improving equipment **durability**, particularly in areas subject to weld spatter.

## Product Advantages

**Spark Resistance** | Flame-retardant PVC jacket protects inner tubing  
Non-adhesive jacket facilitates sheath removal  
Excellent pressure resistance at high temperature

**Robustness & Durability** | Highly kink and crush-resistant  
Excellent compatibility with coolants  
Flow direction marking  
Silicone-free



Industrial Machinery  
Welding Robots  
Cooling  
Aggressive Environments

Applications

## Technical Characteristics

<b>Compatible Fluids</b>	Hot and cold water, refrigerated fluids, compressed air
<b>Working Pressure</b>	0 to 36 bar
<b>Working Temperature</b>	-20°C to +80°C
<b>Component Materials</b>	Polyamide & PVC Sheath

### Regulations

**Industrial**  
DI: 2002/95/EC (RoHS), 2011/65/EC  
DI: 97/23/EC (PED)  
RG: 1907/2006 (REACH)  
UL94 V-0 (Fire resistance)

### Packaging

Tube-pack\*: 25 m, 100 m

Reliable performance is dependent upon the type of fluid conveyed and fittings being used.

### Performance of Anti-Spark PA Tubing with PVC Sheath

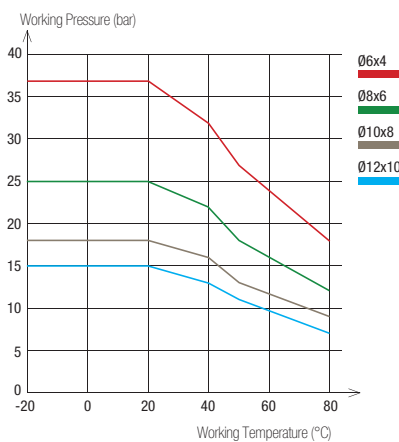

To calculate burst pressure, the values in this graph should be multiplied by 3.

O.D.	Tube O.D. Tolerance	PVC Sheath Thickness
<b>PVC Sheath 8 to 14 mm</b>	+0.10 / -0.10	1 mm
<b>Inner Tubing 6 to 12 mm</b>	+0.05 / -0.10	

Connected to Parker Legris push-in fittings, the calibration of PA tubing ensures perfect sealing based on NF E49-100 (semi-rigid PA inner tubing).

Tube O.D.	Sheath Removal Length for LF 3600 Push-In Fittings (mm)
4 mm	15± 1
6 mm	18± 1
8 mm	19± 1
10 mm	24± 1
12 mm	25± 1





For other fitting ranges, please consult us.



**1025P..V**

Anti-Spark Polyamide (PA) Tubing





Tubepack® 25 m

Ø ext. (mm)	Ø int. (mm)					kg
6	4	25	<a href="#">1025P06V01</a>	<a href="#">1025P06V03</a>	<a href="#">1025P06V04</a>	1,238
8	6	30	<a href="#">1025P08V01</a>	<a href="#">1025P08V03</a>	<a href="#">1025P08V04</a>	1,693
10	8	55	<a href="#">1025P10V01</a>	<a href="#">1025P10V03</a>	<a href="#">1025P10V04</a>	2,029
12	10	70	<a href="#">1025P12V01</a>		<a href="#">1025P12V04</a>	2,970

**1100P..V**

Anti-Spark Polyamide (PA) Tubing

Tubepack® 100 m

Ø ext. (mm)	Ø int. (mm)					kg
6	4	25	<a href="#">1100P06V01</a>	<a href="#">1100P06V03</a>	<a href="#">1100P06V04</a>	2,338
8	6	30	<a href="#">1100P08V01</a>	<a href="#">1100P08V03</a>	<a href="#">1100P08V04</a>	3,767
10	8	55	<a href="#">1100P10V01</a>	<a href="#">1100P10V03</a>	<a href="#">1100P10V04</a>	4,767
12	10	70	<a href="#">1100P12V01</a>		<a href="#">1100P12V04</a>	6,567

**6000 71 00**

Stripping Tool for Anti-Spark Tubing

Technical polymer, stainless steel



6000 71 00

kg

0.098

**Working Principle**Stripping Tool **6000 71 00**

1. Place tube in stripping tool to adjust the blade height to the tube thickness.



2. Blade height is adjusted using the wheel at the bottom of the handle.

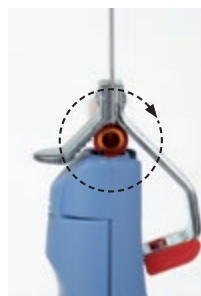

3. Once adjustments have been made, perform a 360° rotation around the tube with the tool.

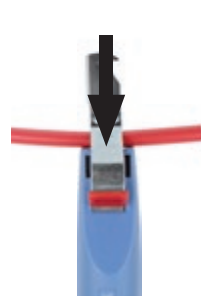

4. Push down firmly on the metal part of the tool in order to hold tube properly.



5. Move the tool to the end of the tube to create an axial opening of the sheath.



6. The tube is correctly stripped.

# PU Tubing

Polyurethane's **3 specific materials** - ether, ester and food-grade "crystal" - offer excellent flexibility and outstanding use in a wide range of applications, allowing for up to **50% space reduction** when compared to semi-rigid PA tubing.

## Product Advantages

### Excellent Mechanical Properties

- Consistent tensile strength for optimum longevity
- Optimal bend radius
- Good vibration absorption
- Unsurpassed abrasion resistance for a single layer tubing
- UV-resistant
- Superior vacuum capability due to surface hardness
- Remaining length marking
- Silicone-free

### 3 Material Grades

- PU ester: perfect for pneumatic applications
- PU ether: no water absorption ; superior chemical resistance to PU ester
- PU ether food-grade "crystal":
  - identification of fluids and circuits
  - chemical resistance superior to PU ether
  - improved longevity



**Applications**

- Food Process
- Robotics
- Cabling
- Pneumatics
- Automation
- In-Plant Automotive
- Rapid Cycles

## Technical Characteristics

<b>Compatible Fluids</b>	Compressed air, industrial fluids (depending on the material type)
<b>Working Pressure</b>	Vacuum to 12 bar
<b>Working Temperature</b>	-20°C to +70°C
<b>Component Materials</b>	Polyurethane ester (52 Shore D) Polyurethane ether (52 Shore D) Polyurethane ether food-grade "crystal" (52 Shore D)

### Regulations

#### Industrial

- DI: 2002/95/EC (RoHS), 2011/65/EC
- DI: 97/23/EC (PED)
- RG: 1907/2006 (REACH)

#### Food (PU ether food-grade "crystal")

- FDA: 21 CFR 177.2600, 178.3297, 176.170, 178.2010
- RG: 1935/2004 EC

Reliable performance is dependent upon the type of fluid conveyed and fittings being used. Use is guaranteed with a vacuum of 755 mm Hg (99% vacuum).

### Performance of PU Tubing

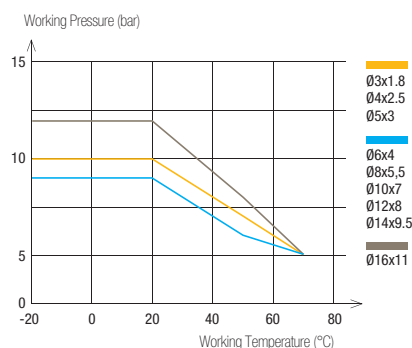

Tube O.D.	Tube O.D. Tolerance
3 to 8 mm	+0.10 / -0.10
10 to 16 mm	+0.15 / -0.15

Connected to Parker Legris push-in fittings, the calibration of PU tubing ensures perfect sealing based on NF E49-101.

### Packaging







- Tube pack: 25 m, 100 m
- Drum: 300 m, 500 m, 1000 m

To calculate burst pressure, the values in this graph should be multiplied by 3.

**1025U**

## Polyurethane (PU) Ester Tubing

Tubepack® 25 m







Ø ext. (mm)	Ø int. (mm)								kg
3	1.8	8	1025U03 01 18						0.020
4	2.5	10	1025U04 01	1025U04 02	1025U04 03	1025U04 04	1025U04 05	1025U04 06	0.310
5	3	13	1025U05 01			1025U05 04			0.522
6	4	15	1025U06 01	1025U06 02	1025U06 03	1025U06 04	1025U06 05	1025U06 06	0.591
8	5.5	20	1025U08 01	1025U08 02	1025U08 03	1025U08 04	1025U08 05	1025U08 06	0.971
10	7	25	1025U10 01	1025U10 02		1025U10 04	1025U10 05	1025U10 06	1.467
12	8	35	1025U12 01	1025U12 02		1025U12 04	1025U12 05	1025U12 06	2.406
14	9.5	45	1025U14 01 95			1025U14 04 95			2.815
16	11	45	1025U16 01 11	1025U16 02 11	1025U16 03 11	1025U16 04 11			2.815

Inch tubing available upon request

**1100U**

## Polyurethane (PU) Ester Tubing

Tubepack® 100 m







Ø ext. (mm)	Ø int. (mm)								kg
4	2.5	10	1100U04 01	1100U04 02	1100U04 03	1100U04 04	1100U04 05	1100U04 06	1.092
5	3	13	1100U05 01			1100U05 04			1.092
6	4	15	1100U06 01	1100U06 02	1100U06 03	1100U06 04	1100U06 05	1100U06 06	2.064
8	5.5	20	1100U08 01	1100U08 02	1100U08 03	1100U08 04	1100U08 05	1100U08 06	3.610
10	7	25	1100U10 01			1100U10 04			6.105
12	8	35	1100U12 01			1100U12 04			8.610
14	9.5	45	1100U14 01 95			1100U14 04 95			11.215
16	11	45	1100U16 01 11	1100U16 02 11	1100U16 03 11	1100U16 04 11			12.176

Inch tubing available upon request

**2003U**

## Polyurethane (PU) Ester Tubing







Drum 300 m

Ø ext. (mm)	Ø int. (mm)								kg
10	7	25	2003U10 01	2003U10 02	2003U10 03	2003U10 04	2003U10 05	2003U10 06	16.600

**2005U**

## Polyurethane (PU) Ester Tubing







Drum 500 m

Ø ext. (mm)	Ø int. (mm)								kg
8	5.5	20	2005U08 01	2005U08 02	2005U08 03	2005U08 04	2005U08 05		17.100

**2010U**

## Polyurethane (PU) Ester Tubing









Drum 1000 m

Ø ext. (mm)	Ø int. (mm)								kg
4	2.5	12	2010U04 01	2010U04 02	2010U04 03	2010U04 04	2010U04 05	2010U04 06	9.840
6	4	15	2010U06 01	2010U06 02	2010U06 03	2010U06 04	2010U06 05	2010U06 06	20.460

## 1025U..R

Polyurethane (PU) Ether Tubing









Tubepack® 25 m

Ø ext. (mm)	Ø int. (mm)									kg
4	2.5	12	1025U04R01	1025U04R04	1025U04R08	1025U04R12	1025U04R13	1025U04R14	1025U04R17	0.310
5	3	13			1025U05R08					0.522
6	4	15	1025U06R01	1025U06R04	1025U06R08	1025U06R12	1025U06R13	1025U06R14	1025U06R17	0.591
8	5.5	20	1025U08R01	1025U08R04	1025U08R08	1025U08R12	1025U08R13	1025U08R14	1025U08R17	0.971
10	7	25	1025U10R01	1025U10R04	1025U10R08			1025U10R14		1.467
12	8	35	1025U12R01	1025U12R04	1025U12R08			1025U12R14		2.406
14	9.5	45		1025U14R01 95						2.421
16	11	45			1025U16R08 11					2.815

## 1100U..R

Polyurethane (PU) Ether Tubing





Tubepack® 100 m

Ø ext. (mm)	Ø int. (mm)									kg
4	2.5	12	1100U04R01	1100U04R04	1100U04R08	1100U04R12	1100U04R13	1100U04R14	1100U04R17	1.092
6	4	15	1100U06R01	1100U06R04	1100U06R08	1100U06R12	1100U06R13	1100U06R14	1100U06R17	2.064
8	5.5	20	1100U08R01	1100U08R04	1100U08R08	1100U08R12	1100U08R13	1100U08R14	1100U08R17	3.610
10	7	25			1100U10R08			1100U10R14		6.109
12	8	35			1100U12R04					8.610
14	9.5	45			1100U14R08 95					11.215
16	11	45			1100U16R08 11					12.176

## 2003U..R

Polyurethane (PU) Ether Tubing





Drum 300 m

Ø ext. (mm)	Ø int. (mm)					kg
10	7	25	2003U10R01	2003U10R04	2003U10R08	16.600

## 2005U..R

Polyurethane (PU) Ether Tubing





Drum 500 m

Ø ext. (mm)	Ø int. (mm)					kg
8	5.5	20	2005U08R01	2005U08R04	2005U08R08	15.600

## 2010U..R

Polyurethane (PU) Ether Tubing

Drum 1000 m

Ø ext. (mm)	Ø int. (mm)					kg
4	2.5	12	2010U04R01	2010U04R04	2010U04R08	8.670
6	4	15	2010U06R01	2010U06R04	2010U06R08	18.600



Flexible Calibrated Tubing

Technical Tubing  
and Hose

# Antistatic PU Tubing

With a constant **10<sup>2</sup> Ω.m resistivity** across the entire thickness of the tubing wall, this tubing guarantees **perfect dissipation of accumulated static electricity**, thereby increasing safety.

## Product Advantages

**Security** | Low resistivity throughout the material  
 Suitable for ATEX\* areas  
 Superior longevity  
 Excellent vibration absorption  
 UV-resistant  
 Silicone-free

**Machinery Optimisation** | Minimum bend radius allowing maximum space saving  
 Good chemical resistance  
 Wide temperature range  
 Stable chemical characteristics throughout tubing



Antistatic Packaging  
 Pneumatics  
 Electronics  
 Spray Painting  
 Electrical Converters

Applications

## Technical Characteristics

<b>Compatible Fluids</b>	Compressed air, industrial fluids
<b>Working Pressure</b>	Vacuum to 10 bar
<b>Working Temperature</b>	-20°C to +70°C
<b>Component Materials</b>	Polyurethane with conductive additive (50 shore D)

### Regulations

DI: 94/9/EC (ATEX\*)  
 DI: 1907/2006 (REACH)  
 DI: 2002/95/EC (RoHS), 2011/65/EC  
 \*For ATEX areas, please consult us

Reliable performance is dependent upon the type of fluid conveyed and fittings being used. Use is guaranteed with a vacuum of 755 mm Hg (99% vacuum).

### Performance of Antistatic PU Tubing

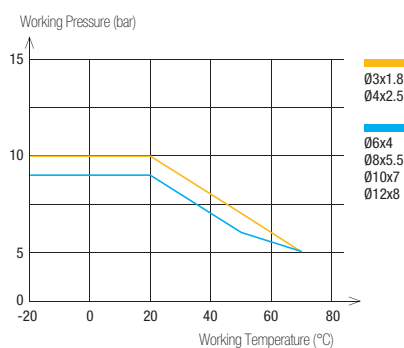

To calculate burst pressure, the values in this graph should be multiplied by 3.

Tube O.D.	Tube O.D. Tolerance
3 to 8 mm	+0.10 / -0.10
10 to 12 mm	+0.15 / -0.15

Connected to Parker Legris push-in fittings, the calibration of Parker Legris tubing ensures perfect sealing based on NF E49-101.



### Packaging

Tube pack\*: 25 m, 100 m





## 1025U..A Anti-Static Polyurethane (PU) Ester Tubing

Tubepack® 25 m

Ø ext. (mm)	Ø int. (mm)			kg
4	2.5	12	<a href="#">1025U04A01</a>	0.260
6	4	15	<a href="#">1025U06A01</a>	0.500
8	5.5	25	<a href="#">1025U08A01</a>	1.260

## 1100U..A Anti-Static Polyurethane (PU) Ester Tubing

Tubepack® 100 m

Ø ext. (mm)	Ø int. (mm)			kg
3	1.8	10	<a href="#">1100U03A01</a>	0.836
4	2.5	12	<a href="#">1100U04A01</a>	1.092
6	4	15	<a href="#">1100U06A01</a>	2.064
8	5.5	25	<a href="#">1100U08A01</a>	3.610
10	7	35	<a href="#">1100U10A01</a>	6.105
12	8	45	<a href="#">1100U12A01</a>	8.610

Flexible Calibrated Tubing

Technical Tubing and Hose

### Related Products

To maintain the antistatic properties throughout the circuit, it is recommended that this tubing be used with metallic fittings.

#### Push-In Fittings

[LF 3600](#) P. 1-95



[LF 3800](#) P. 1-113



[LF 3900](#) P. 1-113



#### Compression Fittings

[Brass](#) P. 5-5



[Stainless Steel](#) P. 5-31





# Anti-Spark PU Tubing

Combining **outstanding spark resistance** with superb **flexibility**, this range is perfectly suited for welding applications.

Two types of PU - ether with PVC sheath or single layer ether - are available and allow **rapid installation** with Parker Legris push-in fittings.

## Product Advantages

### PU with PVC Sheath

- High resistance to kinking and abrasion
- Non-adhesive jacket facilitating sheath removal
- Fluid direction marking
- Self-extinguishing sheath, protecting the inner tubing
- Silicone-free

### Single Layer PU

- Minimum bend radius for maximum space saving
- Significant flexibility for rapid cycling
- Good chemical resistance
- Flow direction marking
- Fireproof material
- Silicone-free



- Applications
- Industrial Machinery
  - Compressed Air
  - Robotics
  - Mechanical Constraints
  - Cooling
  - Welding
  - Cabling

## Technical Characteristics

<b>Compatible Fluids</b>	Industrial fluids, compressed air, coolants
<b>Working Pressure</b>	Vacuum to 14 bar
<b>Working Temperature</b>	-20°C to +70°C
<b>Component Materials</b>	PU ether with PVC sheath PU ether single layer

O.D. of Tube	Sheath Removal Length for LF 3600 (mm)
4 mm	15± 1
6 mm	18± 1
8 mm	19± 1
10 mm	24± 1
12 mm	25± 1

### Regulations

UL94 V-0 (Fire resistance)  
 DI: 2002/95/EC (RoHS),  
 2011/65/EC  
 RG: 1907/2006 (REACH)

### Packaging

Tube pack\*: 25 m, 100 m

Reliable performance is dependent upon the type of fluid conveyed and fittings being used. Use is guaranteed with a vacuum of 755 mm Hg (99% vacuum).

For other fitting ranges or other tube diameters, please consult us.

### Tubing Performance

#### Anti-Spark PU Tubing, with PVC Sheath

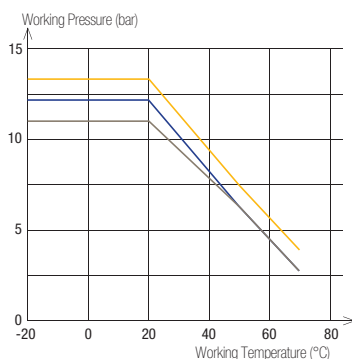

#### Anti-Spark PU Tubing, Single Layer

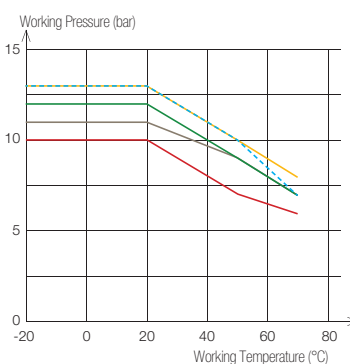





Tube O.D.	Tube O.D. Tolerance	Thickness and Tolerances of PVC Sheath
4 to 8 mm	+0.10 / -0.10	1mm +0.10 / -0.10
10 to 14 mm	+0.15 / -0.15	





Connected to Parker Legris push-in fittings, the calibration of Parker Legris tubing ensures perfect sealing based on NF E49-101 (inner tubing for sheathed or single layer tubing).

To calculate burst pressure, the values in these graphs should be multiplied by 3.  
 For diameter 14x9.5: tubing performances available upon request.





## 1025U..V Anti-Spark Sheath Polyurethane (PU) Ether Tubing Tubepack® 25 m

Ø ext. (mm)	Ø int. (mm)					kg
6	4	12	1025U06V01	1025U06V03	1025U06V04	1.200
8	5.5	20	1025U08V01	1025U08V03	1025U08V04	1.620
10	7	25	1025U10V01	1025U10V03	1025U10V04	2.900
12	8	35	1025U12V01		1025U12V04	4.030





## 1100U..V Anti-Spark Sheath Polyurethane (PU) Ether Tubing Tubepack® 100 m

Ø ext. (mm)	Ø int. (mm)					kg
6	4	12	1100U06V01	1100U06V03	1100U06V04	5.370
8	5.5	20	1100U08V01	1100U08V03	1100U08V04	7.630
10	7	25	1100U10V01	1100U10V03	1100U10V04	10.860
12	8	35	1100U12V01		1100U12V04	15.060

## 1025U..K Single Layer Anti-Spark Polyurethane (PU) Ether Tubing Tubepack® 25 m

Ø ext. (mm)	Ø int. (mm)						kg
4	2.5	12	1025U04K01		1025U04K03		0.230
6	4	15	1025U06K01		1025U06K03	1025U06K04	0.580
8	5.5	20	1025U08K01	1025U08K02	1025U08K03	1025U08K04	0.860
10	7	25	1025U10K01	1025U10K02	1025U10K03	1025U10K04	1.230
12	8	35	1025U12K01	1025U12K02	1025U12K03	1025U12K04	2.080
14	9.5	45			1025U14K03 95		2.620

## 1100U..K Single Layer Anti-Spark Polyurethane (PU) Ether Tubing Tubepack® 100 m

Ø ext. (mm)	Ø int. (mm)						kg
4	2.5	12	1100U04K01				0.900
6	4	15	1100U06K01		1100U06K03	1100U06K04	2.320
8	5.5	20	1100U08K01	1100U08K02	1100U08K03	1100U08K04	3.030
10	7	25	1100U10K01	1100U10K02	1100U10K03	1100U10K04	5.100
12	8	35	1100U12K01	1100U12K02	1100U12K03	1100U12K04	8.600
14	9.5	45			1100U14K03 95		10.676

## 6000 71 00 Stripping Tool for Anti-Spark Tubing

Technical polymer, stainless steel



6000 71 00

kg

0.098

Working principle of the stripping tool page 3-17



# PE Tubing

Parker Legris offers two types of polyethylene tubing: "**Advanced PE**" 50% reticulated and **Low Density PE**. Our range of "Advanced PE" is designed for demanding environments, especially that of water treatment, without compromising operator **safety**.

## Product Advantages

**Advanced PE**

- 50% reticulated material
- Best balance between flexibility and pressure/temperature resistance
- Resistant to a wide range of aggressive chemicals
- UV-stabilised: ideal for outdoor applications
- Approved for permanent contact with food and beverages
- Silicone-free

**Low Density PE**

- Excellent resistance to aggressive and corrosive agents
- Good technical trade-off
- Food-grade material
- Silicone-free



**Applications**

- Beverage
- Chemical
- Petrochemical
- Food Process
- Water
- Water Treatment

## Technical Characteristics

Tube	Advanced PE	Low Density PE
<b>Compatible Fluids</b>	Water, beverages and other fluids	Industrial fluids
<b>Working Pressure</b>	Vacuum to 16 bar	Vacuum to 20 bar
<b>Working Temperature</b>	-40°C to +95°C	-40°C to +60°C
<b>Component Materials</b>	High quality polyethylene: 50% reticulated PE 50% low density PE (44 shore D)	Low Density Polyethylene (44 shore D)

### Regulations

#### Advanced PE Tubing

FDA: 21 CFR 177.1520  
 RG: 1935/2004/EC  
 DI: 97/23/EC (PED)  
 DI: 2002/95/EC (RoHS), 2011/65/EC  
 NSF 42/58 (1/4" and 3/8" approved for 10 bar and 1/2" approved for 8 bar at room temperature)  
 NSF 51, 61 C-HOT  
 ACS (except for purple colour)  
 WRAS  
 RG: 1907/2006 (REACH)

#### Low Density PE Tubing

FDA: 21 CFR 177.1520  
 DI: 2002/95/EC (RoHS), 2011/65/EC  
 DI: 97/23/EC (PED)

Reliable performance is dependent upon the type of fluid conveyed and fittings being used. Use is guaranteed with a vacuum of 755 mm Hg (99% vacuum).

### Tubing Performance

#### Advanced PE Tubing

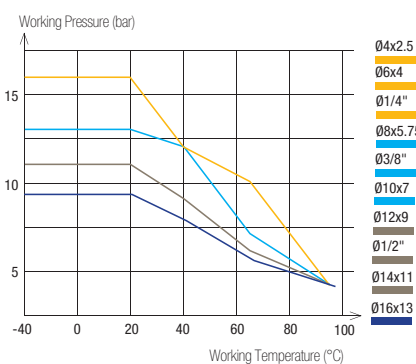

#### Low Density PE Tubing

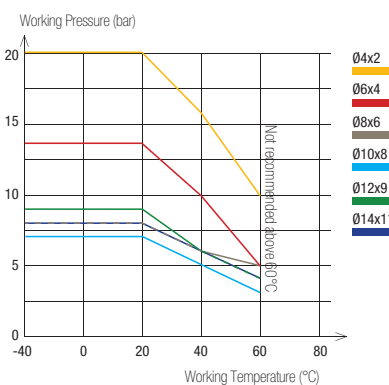

Tube O.D.	Tube O.D. Tolerance
1/4" to 1/2"	+0.10 / -0.10
4 to 16 mm	+0.10 / -0.10

Connected to Parker Legris push-in fittings, the calibration of Parker Legris tubing ensures perfect sealing.









#### Packaging

Advanced PE Tubing  
 Drum: 75 m, 150 m, 300 m  
 250 feet, 500 feet, 1 000 feet  
 PE Tubing  
 Tubepack: 25 m, 100 m

**1015Y..F**

Advanced Polyethylene (APE) Tubing









Drum 150 m

Ø ext. (mm)	Ø int. (mm)		 clear						 white	kg
4	2.5	16	1015Y04F00	1015Y04F01	1015Y04F02	1015Y04F03	1015Y04F04	1015Y04F05	1015Y04F10	4.914
6	4	32	1015Y06F00	1015Y06F01	1015Y06F02	1015Y06F03	1015Y06F04	1015Y06F05	1015Y06F10	5.434
8	5.75	40	1015Y08F00	1015Y08F01	1015Y08F02	1015Y08F03	1015Y08F04	1015Y08F05	1015Y08F10	3.279
10	7	40	1015Y10F00	1015Y10F01	1015Y10F02	1015Y10F03	1015Y10F04	1015Y10F05	1015Y10F10	5.318

**1030Y..F**

Advanced Polyethylene (APE) Tubing









Drum 300 m

Ø ext. (mm)	Ø int. (mm)		 clear						 white	kg
4	2.5	16	1030Y04F00	1030Y04F01	1030Y04F02	1030Y04F03	1030Y04F04	1030Y04F05	1030Y04F10	2.860
6	4	32	1030Y06F00	1030Y06F01	1030Y06F02	1030Y06F03	1030Y06F04	1030Y06F05	1030Y06F10	5.318

**1075Y..F**

Advanced Polyethylene (APE) Tubing









Drum 75 m

Ø ext. (mm)	Ø int. (mm)		 clear						 white	kg
12	9	55	1075Y12F00	1075Y12F01	1075Y12F02	1075Y12F03	1075Y12F04	1075Y12F05	1075Y12F10	3.852
14	11	75	1075Y14F00							5.850
16	13	95	1075Y16F01							7.550

**1096Y..F**

Advanced Polyethylene (APE) Tubing









Drum 250 ft

Ø ext. (mm)	Ø int. (mm)		 clear						 white	kg
1/2	0.375	1.96	1096Y62F00	1096Y62F01	1096Y62F02	1096Y62F03	1096Y62F04	1096Y62F05	1096Y62F10	4.200

**1098Y..F**

Advanced Polyethylene (APE) Tubing









Drum 500 ft

Ø ext. (mm)	Ø int. (mm)		 clear						 white	kg
1/4	0.170	0.78	1098Y56F00	1098Y56F01	1098Y56F02	1098Y56F03	1098Y56F04	1098Y56F05	1098Y56F10	2.334
3/8	0.250	1.18	1098Y60F00	1098Y60F01	1098Y60F02	1098Y60F03	1098Y60F04	1098Y60F05	1098Y60F10	5.518

**1099Y..F**

Advanced Polyethylene (APE) Tubing



Drum 1000 ft

Ø ext. (mm)	Ø int. (mm)		 clear						 white	kg
1/4	0.170	0.78	1099Y56F00	1099Y56F01	1099Y56F02	1099Y56F03	1099Y56F04	1099Y56F05	1099Y56F10	4.718

## Low Density Polyethylene

**1100Y**

Tubepack® 100 m

Ø ext. (mm)	Ø int. (mm)		 clear	kg
4	2	25	1100Y04 00	0.910
6	4	35	1100Y06 00	1.500
8	6	55	1100Y08 00	2.140
10	8	80	1100Y10 00	2.710
12	9	65	1100Y12 00	4.750
14	11	80	1100Y14 00	5.650

# Fluoropolymer Tubing – FEP

**FEP** (fluorinated ethylene propylene) tubing is a **robust engineering fluoropolymer** which provides excellent fluid visibility and is perfect for flow control monitoring.

## Product Advantages

**Flow Control** | Transparent  
Flexible and non-flammable material  
Resistant to nearly all chemicals and solvents

**Tried-&-Tested Properties** | Excellent transmission of UV light  
Low friction coefficient  
Food-grade material  
Low permeability  
Easily weldable  
Silicone-free



**Applications**  
Instrumentation  
Food Process  
UV  
Gas Sampling  
Chemical  
Temperature Cycling  
Laboratory

## Technical Characteristics

<b>Compatible Fluids</b>	Industrial fluids
<b>Working Pressure</b>	0 to 28 bar
<b>Working Temperature</b>	-40°C to +150°C
<b>Component Materials</b>	Fluorinated ethylene propylene (pure) (55 Shore D)

### Regulations

**Food**  
FDA: 21 CFR 177.1550  
RG: 1935/2004  
**Industrial**  
UL94 V-0 (Fire resistance)  
DI: 2002/95/EC (RoHS), 2011/65/EC  
DI: 97/23/EC (PED)  
RG: 1907/2006 (REACH)

Reliable performance is dependent upon the type of fluid conveyed and fittings being used.

### Performance of FEP Tubing

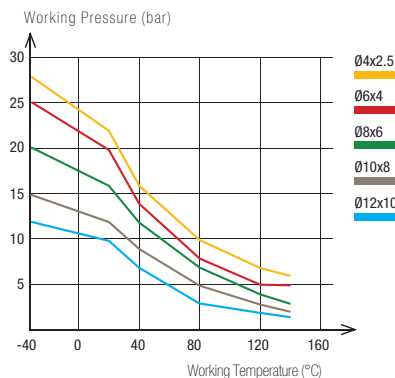

Tube O.D.	Tube O.D. Tolerance
4 mm	+0.05 / -0.05
6 to 10 mm	+0.07 / -0.07
12 mm	+0.10 / -0.10



**Packaging**  
Tubepack®: 5 m, 25 m

Connected to Parker Legris push-in fittings, the calibration of Parker Legris tubing ensures perfect sealing.

## 1005T

### Fluoropolymer (FEP) Tubing



Tubepack® 5 m

Ø ext. (mm)	Ø int. (mm)			kg
4	2.5	40	<a href="#">1005T04 00 25</a>	0.155
6	4	50	<a href="#">1005T06 00</a>	0.250
8	6	70	<a href="#">1005T08 00</a>	0.385
10	8	120	<a href="#">1005T10 00</a>	0.524
12	10	180	<a href="#">1005T12 00</a>	0.547

## 1025T

### Fluoropolymer (FEP) Tubing

Tubepack® 25 m

Ø ext. (mm)	Ø int. (mm)			kg
4	2.5	40	<a href="#">1025T04 00 25</a>	0.506
6	4	50	<a href="#">1025T06 00</a>	1.025
8	6	70	<a href="#">1025T08 00</a>	1.431
10	8	120	<a href="#">1025T10 00</a>	1.693
12	10	180	<a href="#">1025T12 00</a>	1.913

## Related Products

Parker Legris stainless steel fittings are perfectly suited for use with fluoropolymer tubing (PFA, FEP).

### Push-In Fittings

[LF 3800](#) P. 1-77



[LF 3900](#) P. 1-77



### Compression Fittings

[Stainless Steel](#) P. 5-31



# Fluoropolymer Tubing - PFA

Parker Legris **PFA** (perfluoroalkoxy) tubing offers **10 times greater durability** than other fluoropolymer tubings (PTFE, FEP and PVDF) under severe chemical and mechanical conditions. This tubing range is available in **three material grades**, offering perfect compatibility with all applications, even in extreme environments.

## Product Advantages

### Great Versatility

- Exceptional chemical inertia
- A flexible alternative to stainless steel tubing
- Broad range of working temperatures, from cryogenic to extreme heat
- Non-stick properties allowing conveyance of many fluids & gases
- Outstanding resistance to ageing
- Fluoropolymer with the lowest permeability
- Non-flammable
- UV-transparent
- Tube marking on request
- Silicone-free

### Three Material Grades

- Clear High Purity PFA: to cover all applications, including those requiring maximum mechanical resistance
- Coloured PFA: for circuit identification
- Black Antistatic PFA: eliminates all risk of electrostatic discharge



Applications

- Food Process
- Fuel Cells
- Electrical/Electronics
- Aircraft
- Oil/Gas Industry
- Pharmaceutical
- Medical
- Chemical
- Clean Rooms

## Technical Characteristics

<b>Compatible Fluids</b>	Medical, bio-compatible, food process, gas, compressed air
<b>Working Pressure</b>	Vacuum to 36 bar
<b>Working Temperature</b>	-196°C to +260°C
<b>Component Materials</b>	Perfluoroalkoxy - 55 Shore D <ul style="list-style-type: none"> <li>• High Purity PFA</li> <li>• Translucent coloured PFA</li> <li>• Antistatic PFA</li> </ul>

Reliable performance is dependent upon the type of fluid conveyed and fittings being used. Use is guaranteed with a vacuum of 755 mm Hg (99% vacuum).

### Regulations

#### Medical

USP: Class VI (A)  
External communication devices

#### Industrial

UL94 V-0 (Fire resistance)  
DI: 2002/95/EC (RoHS), 2011/65/EC  
DI: 97/23/EC (PED)  
RG: 1907/2006 (REACH)  
DI: 94/09/EC (ATEX, black tubing)

#### Food Industry

FDA: 21 CFR 177.1550  
(clear, translucent coloured)  
RG: 1935/2004

### Performance of PFA Tubing

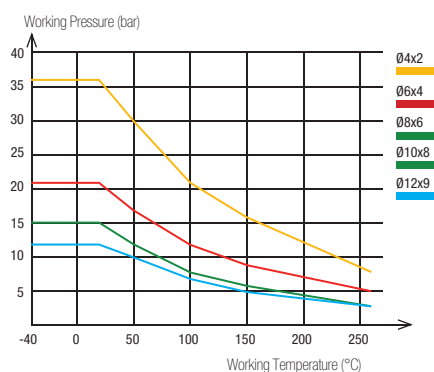

Tube O.D.	Tube O.D. Tolerance
4 to 8 mm	+0.10 / -0.10
10 to 12 mm	+0.15 / -0.15

### Packaging

Tube pack: 10 m, 50 m, 100 m





Connected to Parker Legris push-in fittings, the calibration of Parker Legris tubing ensures perfect sealing based on NF E49-100.

To calculate burst pressure, the values in this graph should be multiplied by 3.







**1010T..P** Fluoropolymer (FEP) Tubing

Tubepack® 10 m

Ø ext. (mm)	Ø int. (mm)						kg
4	2	12	<a href="#">1010T04P00</a>	<a href="#">1010T04P12</a>	<a href="#">1010T04P13</a>	<a href="#">1010T04P14</a>	0.087
6	4	34	<a href="#">1010T06P00</a>	<a href="#">1010T06P12</a>	<a href="#">1010T06P13</a>	<a href="#">1010T06P14</a>	0.237
8	6	60	<a href="#">1010T08P00</a>	<a href="#">1010T08P12</a>	<a href="#">1010T08P13</a>	<a href="#">1010T08P14</a>	0.410
10	8	95	<a href="#">1010T10P00</a>				0.723
12	9	120	<a href="#">1010T12P00</a>				1.148



**1050T..P** Fluoropolymer (FEP) Tubing

Tubepack® 50 m

Ø ext. (mm)	Ø int. (mm)						kg
4	2	12	<a href="#">1050T04P00</a>	<a href="#">1050T04P12</a>	<a href="#">1050T04P13</a>	<a href="#">1050T04P14</a>	0.435
6	4	34	<a href="#">1050T06P00</a>	<a href="#">1050T06P12</a>	<a href="#">1050T06P13</a>	<a href="#">1050T06P14</a>	1.185
8	6	60	<a href="#">1050T08P00</a>	<a href="#">1050T08P12</a>	<a href="#">1050T08P13</a>	<a href="#">1050T08P14</a>	2.050
10	8	95	<a href="#">1050T10P00</a>				3.615
12	9	120	<a href="#">1050T12P00</a>				5.740



**1100T..P** Fluoropolymer (FEP) Tubing

Tubepack® 100 m

Ø ext. (mm)	Ø int. (mm)			kg
4	2	12	<a href="#">1100T04P00</a>	0.870
6	4	34	<a href="#">1100T06P00</a>	2.370
8	6	60	<a href="#">1100T08P00</a>	4.100
10	8	95	<a href="#">1100T10P00</a>	7.230
12	9	120	<a href="#">1100T12P00</a>	11.480



**1010T..A** Fluoropolymer (FEP) Antistatic Tubing

Tubepack® 10 m

Ø ext. (mm)	Ø int. (mm)			kg
4	2	12	<a href="#">1010T04A01</a>	0.087
6	4	34	<a href="#">1010T06A01</a>	0.237
8	6	60	<a href="#">1010T08A01</a>	0.410

**1050T..A** Fluoropolymer (FEP) Antistatic Tubing

Tubepack® 50 m

Ø ext. (mm)	Ø int. (mm)			kg
4	2	12	<a href="#">1050T04A01</a>	0.435
6	4	34	<a href="#">1050T06A01</a>	1.185
8	6	60	<a href="#">1050T08A01</a>	2.050

# Multi-Tubing

Our range of multi-tubing combines high quality performance and **space optimisation** in complex pneumatic circuits **covering a wide range of environments**. **Many possible configurations** are available, depending on the pressure, temperature, flexibility and compatibility requirements.

## Product Advantages

### Sheathed PA Tubing

- PVC sheath resistant to external damage:
  - abrasion
  - weld spatter
  - aggressive fluids
- Helically wound: minimum bend radius, compact installation
- Simplified routing
- Easy identification of circuits
- Same technical performance as PA
- Possible number of tubes: from 2 to 12, with numbering
- Silicone-free

### Twin PU Ester Tubing

- Tubes fully joined for improved solidity
- External diameter maintained after separation
- Rapid identification of circuits
- Quick and easy installation
- Simplified routing
- 3 colour combinations available
- Silicone-free



**Applications**

Pneumatics  
Automation  
Robotics  
Transportation  
In-Plant Automotive  
Process Industry

## Technical Characteristics

Tube	PA	PU
Compatible Fluids	Compressed air, chemicals, industrial fluids	Compressed air, industrial fluids
Working Pressure	Vacuum to 24 bar	0 to 14 bar
Working Temperature	-40°C to +80°C	-20°C to +70°C
Component Materials	Polyamide	Polyurethane ester

Reliable performance is dependent upon the type of fluid conveyed and fittings being used. Use is guaranteed with a vacuum of 755 mm Hg (99% vacuum).

### Regulations

#### Industrial

DI: 2002/95/EC (RoHS), 2011/65/EC  
DI: 97/23/EC (PED)  
RG: 1907/2006 (REACH)

Performance and chemical resistance according to DIN 73378

### Packaging

**Sheathed PA Tubing:**  
Tubepack® 10 m, 50 m

**Twin PU Ester Tubing:**  
Tubepack® 25 m

### Tubing Performance

#### Sheathed PA Tubing

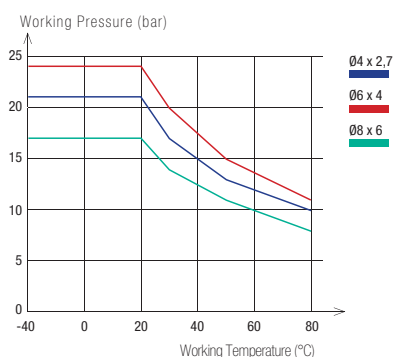

#### Twin PU Ester Tubing

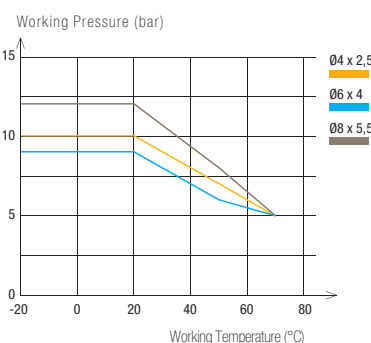



Material	Tube O.D.	Tube O.D. Tolerance
PA	4 mm	+0.05 / -0.08
	6 to 8 mm	+0.05 / -0.10
PU	4 to 8 mm	+0.10 / -0.10

Connected to Parker Legris push-in fittings, the calibration of Parker Legris tubing ensures perfect sealing based on NF E49-100 (for semi-rigid PA) and NF E49-101 (for twin PU ester).

To calculate burst pressure, the values in these graphs should be multiplied by 3.



## 1010P..M Semi-Rigid Polyamide (PA) Multi-Tubing

Reel 10 m

Ø ext. (mm)	Ø int. (mm)		Number of tubes		kg
4	2.7	35	4	<a href="#">1010P04 00M04</a>	1.440
		45	7	<a href="#">1010P04 00M07</a>	1.920
6	4	55	4	<a href="#">1010P06 00M04</a>	2.300
		60	7	<a href="#">1010P06 00M07</a>	2.900
8	6	45	2	<a href="#">1010P08 00M02</a>	2.600





## 1050P..M Semi-Rigid Polyamide (PA) Multi-Tubing

Reel 50 m

Ø ext. (mm)	Ø int. (mm)		Number of tubes		kg
4	2.7	20	2	<a href="#">1050P04 00M02</a>	4.400
		35	4	<a href="#">1050P04 00M04</a>	6.600
		45	7	<a href="#">1050P04 00M07</a>	8.200
		55	12	<a href="#">1050P04 00M12</a>	15.200
6	4	45	2	<a href="#">1050P06 00M02</a>	8.400
		55	4	<a href="#">1050P06 00M04</a>	11.500
		60	7	<a href="#">1050P06 00M07</a>	12.500
8	6	45	2	<a href="#">1050P08 00M02</a>	13.000

## 1420U Twin Polyurethane (PU) Tubing

Tubepack® 25 m

Ø ext. (mm)	Ø int. (mm)					kg
4	2.5	12	<a href="#">1420U04 41</a>	<a href="#">1420U04 44</a>	<a href="#">1420U04 11</a>	0.620
6	4	15	<a href="#">1420U06 41</a>	<a href="#">1420U06 44</a>	<a href="#">1420U06 11</a>	1.182
8	5.5	20	<a href="#">1420U08 41</a>	<a href="#">1420U08 44</a>	<a href="#">1420U08 11</a>	1.942

### Colour Selection



Multi-Tubing  
Semi-Rigid PA/PVC Sheath

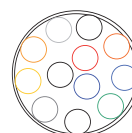
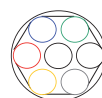

## Related Products

To complement the Multi-Tubing range, Parker Legris proposes multi-connectors, shown in Chapter 1.

### Push-In Fittings

**Multi-Connector** P. 1-31



# PA Recoil Tubing

Parker Legris recoil tubing has a **lasting memory after multiple uses**, offering an **alternative to reels** for excellent ergonomics and space saving. The pre-assembled tubes are equipped with a protection spring, preventing damage to the ends.

## Product Advantages

**Excellent Mechanical Properties**

- Low pressure drop
- Good chemical compatibility
- Self-retracting
- Identical technical performance to PA tubing
- Silicone-free

**Comprehensive Range**

- Ready-to-use
- Various colours for circuit identification
- Available with pre-assembled connectors



**Applications**

- MRO
- Pneumatic Tools
- Transportation
- Lubrication
- Industrial Cleaning
- Robotics
- Car Washing

## Technical Characteristics

<b>Compatible Fluids</b>	Compressed air, lubricants, Other fluids: please consult us
<b>Working Pressure</b>	Vacuum to 20 bar
<b>Working Temperature</b>	-20°C to +80°C
<b>Component Materials</b>	Polyamide (60 Shore D)

### Regulations

DI: 97/23/EC (PED)  
 RG: 1907/2006 (REACH)  
 DI: 2002/95/EC (RoHS), 2011/65/EC

Reliable performance is dependent upon the type of fluid conveyed and fittings being used. Use is guaranteed with a vacuum of 755 mm Hg (99% vacuum).

### Performance of PA Recoil Tubing

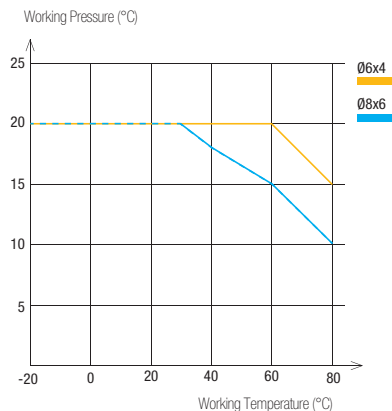

Tube O.D.	Passage	Tube O.D. Tolerance
6 mm	4 mm	+0.05 / -0.10
8 mm	6 mm	+0.05 / -0.10



### Packaging

Plastic bags: 2m to 6 m  
 Other lengths and colours on request

To calculate burst pressure, the values in these graphs should be multiplied by 3.

## 1470P

### Polyamide (PA) Recoil Tubing 2 m, Male BSPT Fitting



Ø ext. (mm)	Ø int. (mm)	BSPT Thread			Total Closed Length (mm)	O.D. of Coil (mm)	kg
6	4	R1/4	1470P06 04 13	1470P06 07 13	520	60	0.143
8	6	R1/4	1470P08 04 13	1470P08 07 13	560	70	0.174

Length of long straight section: 300 mm

Length of short straight section: 100 mm

## 1471P

### Polyamide (PA) Recoil Tubing 4 m, Male BSPT Fitting

Ø ext. (mm)	Ø int. (mm)	BSPT Thread			Total Closed Length (mm)	O.D. of Coil (mm)	kg
6	4	R1/4	1471P06 04 13	1471P06 07 13	640	60	0.199
8	6	R1/4	1471P08 04 13	1471P08 07 13	720	70	0.249

Length of long straight section: 300 mm

Length of short straight section: 100 mm

## 1472P

### Polyamide (PA) Recoil Tubing 6 m, Male BSPT Fitting

Ø ext. (mm)	Ø int. (mm)	BSPT Thread			Total Closed Length (mm)	O.D. of Coil (mm)	kg
6	4	R1/4	1472P06 04 13	1472P06 07 13	760	60	0.260
8	6	R1/4	1472P08 04 13	1472P08 07 13	880	70	0.329

Length of long straight section: 300 mm

Length of short straight section: 100 mm

## Dimensions for Recoil Tubing

Service length: maximum recommended operating length in order to ensure that the coil will continue to contract after multiple uses.

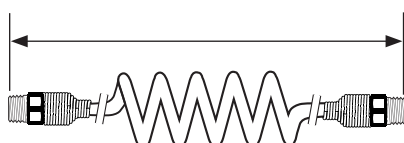

Service Length (mm)

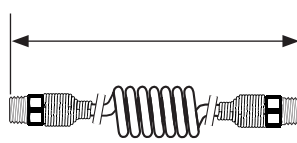

Total Closed Length (mm)

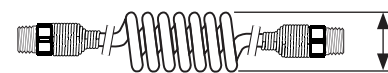

O.D. of Coil (mm)

# PU Recoil Tubing

With its small coil diameter and good impact resistance, this polyurethane recoil tubing is perfect for installations requiring **flexibility** in confined spaces. Good resistance to shock and abrasion, together with a design integrating straight ends, allow for **easy and safe operation** of pneumatic equipment.

## Product Advantages

### Excellent Mechanical Properties

- Excellent coil memory
- Abrasion-resistant
- Perfect for rapid cycling applications
- Consistent tensile strength
- Optimum longevity
- Low pressure drop
- Lightweight with plastic protection spring
- Silicone-free

### Comprehensive Range

- Available in 2 materials: PU ester and PU ether
- With or without pre-assembled fittings
- Pre-assembled plastic or metal protection springs to prevent damage to equipment and tubing



**Applications**

- Workshops
- Tooling
- Pneumatics
- Motion Technologies
- Robotics
- Industrial Machinery

## Technical Characteristics

<b>Compatible Fluids</b>	Compressed air
<b>Working Pressure</b>	0 to 10 bar
<b>Working Temperature</b>	-20°C to +70°C (assembled tubing)
<b>Component Materials</b>	Polyurethane ester: 52 Shore D Polyurethane ether: 46 Shore D

### Regulations

**Industrial**  
 NF E49-101  
 DI: 2002/95/EC (RoHS), 2011/65/EC  
 DI: 97/23/EC (PED)  
 RG: 1907/2006 (REACH)

### Packaging

Plastic bags: from 2 m to 7.5 m

Reliable performance is dependent upon the type of fluid conveyed and fittings being used.

### Performance of PU Recoil Tubing

#### PU Ester Recoil Tubing

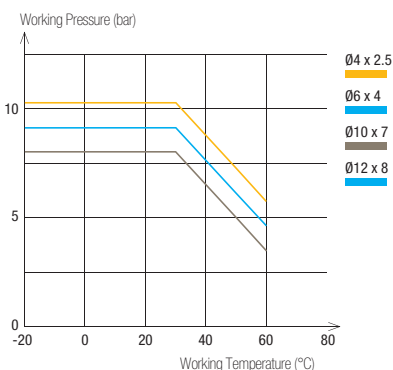

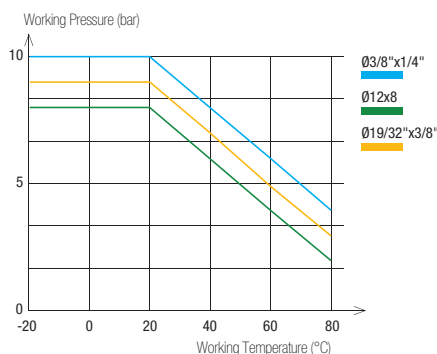

#### PU Ether Recoil Tubing



Tube O.D.	Tube I.D.	Tube O.D. Tolerance
4 to 8 mm	2.5 to 5.5 mm	+0.10 / -0.10
10 to 12 mm	7 to 8 mm	+0.15 / -0.15
3/8" and 19/32"	1/4" and 3/8"	+/- 0.005"



To calculate burst pressure, the values in these graphs should be multiplied by 3.

## 1470U Polyurethane (PU) Ester Recoil Tubing 2 m, Male BSPT Fitting

Ø ext. (mm)	Ø int. (mm)	BSPT Thread				Total Closed Length (mm)	O.D. of Coil (mm)	kg
4	2.5	R1/8	<a href="#">1470U04 03 10</a>	<a href="#">1470U04 04 10</a>	<a href="#">1470U04 05 10</a>	595	24	0.060
6	4	R1/4	<a href="#">1470U06 03 13</a>	<a href="#">1470U06 04 13</a>	<a href="#">1470U06 05 13</a>	630	32	0.060
8	5	R1/4	<a href="#">1470U08 03 13</a>	<a href="#">1470U08 04 13</a>	<a href="#">1470U08 05 13</a>	780	42	0.120
10	7	R1/4	<a href="#">1470U10 03 13</a>	<a href="#">1470U10 04 13</a>	<a href="#">1470U10 05 13</a>	780	62	0.160
12	8	R3/8	<a href="#">1470U12 03 17</a>	<a href="#">1470U12 04 17</a>	<a href="#">1470U12 05 17</a>	780	65	0.190



Length of long straight section, O.D. < 8 mm: 300 mm; Length of long straight section, O.D. ≥ 8 mm: 500 mm; Length of short straight section, for all O.D.: 100 mm

## 1471U Polyurethane (PU) Ester Recoil Tubing 4 m, Male BSPT Fitting

Ø ext. (mm)	Ø int. (mm)	BSPT Thread				Total Closed Length (mm)	O.D. of Coil (mm)	kg
4	2.5	R1/8	<a href="#">1471U04 03 10</a>	<a href="#">1471U04 04 10</a>	<a href="#">1471U04 05 10</a>	785	24	0.100
6	4	R1/4	<a href="#">1471U06 03 13</a>	<a href="#">1471U06 04 13</a>	<a href="#">1471U06 05 13</a>	850	32	0.160
8	5	R1/4	<a href="#">1471U08 03 13</a>	<a href="#">1471U08 04 13</a>	<a href="#">1471U08 05 13</a>	1000	42	0.200
10	7	R1/4	<a href="#">1471U10 03 13</a>	<a href="#">1471U10 04 13</a>	<a href="#">1471U10 05 13</a>	1000	62	0.230
12	8	R3/8	<a href="#">1471U12 03 17</a>	<a href="#">1471U12 04 17</a>	<a href="#">1471U12 05 17</a>	1140	65	0.260

Length of long straight section, O.D. < 8 mm: 300 mm; Length of long straight section, O.D. ≥ 8 mm: 500 mm; Length of short straight section, for all O.D.: 100 mm

## 1472U Polyurethane (PU) Ester Recoil Tubing 6 m, Male BSPT Fitting

Ø ext. (mm)	Ø int. (mm)	BSPT Thread				Total Closed Length (mm)	O.D. of Coil (mm)	kg
8	5	R1/4	<a href="#">1472U08 03 13</a>	<a href="#">1472U08 04 13</a>	<a href="#">1472U08 05 13</a>	1230	42	0.280
10	7	R1/4	<a href="#">1472U10 03 13</a>	<a href="#">1472U10 04 13</a>	<a href="#">1472U10 05 13</a>	1140	62	0.295
12	8	R3/8	<a href="#">1472U12 03 17</a>	<a href="#">1472U12 04 17</a>	<a href="#">1472U12 05 17</a>	1190	65	0.310

Length of long straight section, O.D. < 8 mm: 300 mm; Length of long straight section, O.D. ≥ 8 mm: 500 mm; Length of short straight section, for all O.D.: 100 mm

## 1460U Polyurethane (PU) Ester Recoil Tubing 2 m

Ø ext. (mm)	Ø int. (mm)		Total Closed Length (mm)	O.D. of Coil (mm)	kg
8	5	<a href="#">1460U08 04</a>	720	42	0.064
10	7	<a href="#">1460U10 04</a>	720	62	0.122
12	8	<a href="#">1460U12 04</a>	720	65	0.172

Length of long straight section, O.D. < 8 mm: 300 mm; Length of long straight section, O.D. ≥ 8 mm: 500 mm; Length of short straight section, for all O.D.: 100 mm

## 1461U Polyurethane (PU) Ester Recoil Tubing 4 m

Ø ext. (mm)	Ø int. (mm)		Total Closed Length (mm)	O.D. of Coil (mm)	kg
8	5	<a href="#">1461U08 04</a>	940	42	0.128
10	7	<a href="#">1461U10 04</a>	940	62	0.244
12	8	<a href="#">1461U12 04</a>	940	65	0.344

Length of long straight section, O.D. < 8 mm: 300 mm; Length of long straight section, O.D. ≥ 8 mm: 500 mm; Length of short straight section, for all O.D.: 100 mm

## 1462U Polyurethane (PU) Ester Recoil Tubing 6 m

Ø ext. (mm)	Ø int. (mm)		Total Closed Length (mm)	O.D. of Coil (mm)	kg
8	5	<a href="#">1462U08 04</a>	1260	42	0.192
10	7	<a href="#">1462U10 04</a>	1260	62	1.246
12	8	<a href="#">1462U12 04</a>	1260	65	0.280

Length of long straight section, O.D. < 8 mm: 300 mm; Length of long straight section, O.D. ≥ 8 mm: 500 mm; Length of short straight section, for all O.D.: 100 mm



# PU Recoil Tubing

## 1445U..R Recoil Polyurethane (PU) Ether Tubing 3 m, Male BSPP Fitting

Ø ext. (mm)	Ø int. (mm)	BSPP Thread		Total Closed Length (mm)	O.D. of Coil (mm)	kg
8	5	G1/4	<a href="#">1445U08R04 13</a>	819	40	0.170
3/8"	1/4"	G1/4	<a href="#">1445U60R04 13</a>	769	60	0.230
12	8	G3/8	<a href="#">1445U12R04 17</a>	789	80	0.310
19/32"	3/8"	G3/8	<a href="#">1445U14R04 17</a>	759	110	0.460

## 1441U..R Recoil Polyurethane (PU) Ether Tubing 4 m, Male BSPP Fitting

Ø ext. (mm)	Ø int. (mm)	BSPP Thread		Total Closed Length (mm)	O.D. of Coil (mm)	kg
8	5	G1/4	<a href="#">1441U08R04 13</a>	889	40	0.220
3/8"	1/4"	G1/4	<a href="#">1441U60R04 13</a>	819	60	0.260
12	8	G3/8	<a href="#">1441U12R04 17</a>	849	80	0.400
19/32"	3/8"	G3/8	<a href="#">1441U14R04 17</a>	809	110	0.554

## 1442U..R Recoil Polyurethane (PU) Ether Tubing 6 m, Male BSPP Fitting

Ø ext. (mm)	Ø int. (mm)	BSPP Thread		Total Closed Length (mm)	O.D. of Coil (mm)	kg
8	5	G1/4	<a href="#">1442U08R04 13</a>	1029	40	0.340
3/8"	1/4"	G1/4	<a href="#">1442U60R04 13</a>	929	60	0.360
12	8	G3/8	<a href="#">1442U12R04 17</a>	969	80	0.530
19/32"	3/8"	G3/8	<a href="#">1442U14R04 17</a>	909	110	0.920

## 1447U..R Recoil Polyurethane (PU) Ether Tubing 7.5 m, Male BSPP Fitting

Ø ext. (mm)	Ø int. (mm)	BSPP Thread		Total Closed Length (mm)	O.D. of Coil (mm)	kg
8	5	G1/4	<a href="#">1447U08R04 13</a>	1134	40	0.420
3/8"	1/4"	G1/4	<a href="#">1447U60R04 13</a>	1009	60	0.460
12	8	G3/8	<a href="#">1447U12R04 17</a>	1059	80	0.600
19/32"	3/8"	G3/8	<a href="#">1447U14R04 17</a>	984	110	1.150

# Accessories

## 0694 Push-In Fitting with Protection Spring, Male BSPP Thread

Nickel-plated brass, NBR

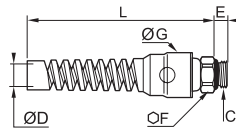

ØD	C		E	F	G	L	kg
8	G1/4	<a href="#">0694 08 13</a>	6.5	16	24	104.5	0.067
10	G1/4	<a href="#">0694 10 13</a>	6.5	18	24	106.5	0.062
12	G3/8	<a href="#">0694 12 17</a>	7.5	20	29.5	126	0.080

## 0695 Push-In Fitting with Protection Spring, Male BSPT Thread

Nickel-plated brass, NBR

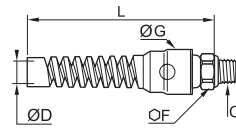

ØD	C		F	G	L	kg
8	R1/4	<a href="#">0695 08 13</a>	14	24	104.5	0.055
10	R1/4	<a href="#">0695 10 13</a>	18	24	106.5	0.064
12	R3/8	<a href="#">0695 12 17</a>	20	29.5	126	0.090

# Braided PU Recoil Hose

This recoil hose offers all the advantages of polyurethane, combining the **durability** and **kink resistance** of bulkier braided hoses with great **elasticity** and maximum **flexibility**.

## Product Advantages

### Excellent Mechanical Properties

Unsurpassed resistance to abrasion: 10 times better than rubber, polyamide and non-braided polyurethane  
 Excellent flexibility and coil memory: minimizes work fatigue  
 Highly kink and crush-resistant  
 Silicone-free

### Ready-to-Use

Pre-assembled threaded fittings  
 Tube ends protected with a plastic spring  
 Lightweight for easy handling  
 3 lengths available  
 Translucent blue: visibility of the fluid



Machine Tools  
 Industrial Assembly  
 Pneumatics  
 In-Plant Automotive  
 Workshops

Applications

## Technical Characteristics

<b>Compatible Fluids</b>	Compressed air Other fluids: please consult us
<b>Working Pressure</b>	0 to 15 bar
<b>Working Temperature</b>	-40°C to +75°C
<b>Component Materials</b>	Polyurethane (85 shore A)

### Regulations

DI: 97/23/EC (PED)  
 RG: 1907/2006 (REACH)  
 DI: 2002/95/EC (RoHS), 2011/65/EC

Reliable performance is dependent upon the type of fluid conveyed and fittings being used.

### Performance of Braided PU Recoil Hose

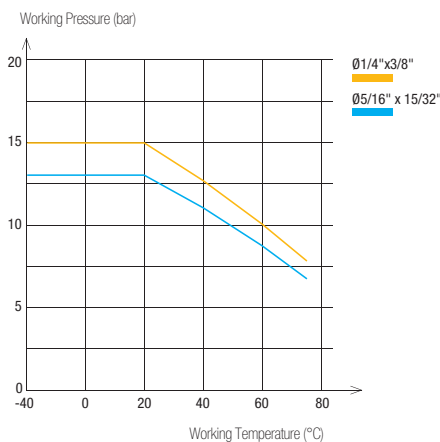

Hose O.D.	Hose I.D.	Hose I.D. Tolerance
3/8" 15/32"	1/4" 5/16"	+/- 0.005"

### Packaging

Plastic bags: 3 m to 7.5 m

Connected to Parker Legris push-in fittings, the calibration of PU tubing ensures perfect sealing.

To calculate burst pressure, the values in this graph should be multiplied by 4.

## 1445U..E Recoil Braided Polyurethane (PU) tubing 3 m, Male BSPP Fitting

Ø ext. (mm)	Ø int. (mm)	BSPP Thread		Total Closed Length (mm)	O.D. of Coil (mm)	kg
3/8"	1/4"	G1/4	<a href="#">1445U60E04 13</a>	870	42	0.210
12	8	G3/8	<a href="#">1445U12E04 17</a>	880	55	0.300

## 1442U..E Recoil Braided Polyurethane (PU) tubing 6 m, Male BSPP Fitting

Ø ext. (mm)	Ø int. (mm)	BSPP Thread		Total Closed Length (mm)	O.D. of Coil (mm)	kg
3/8"	1/4"	G1/4	<a href="#">1442U60E04 13</a>	1140	42	0.420
12	8	G3/8	<a href="#">1442U12E04 17</a>	1160	55	0.600

## 1447U..E Recoil Braided Polyurethane (PU) tubing 7.5 m, Male BSPP Fitting

Ø ext. (mm)	Ø int. (mm)	BSPP Thread		Total Closed Length (mm)	O.D. of Coil (mm)	kg
3/8"	1/4"	G1/4	<a href="#">1447U60E04 13</a>	1275	42	0.525
12	8	G3/8	<a href="#">1447U12E04 17</a>	1300	55	0.750

### Related Products

Parker Legris recoil tubing is designed for use with Parker Legris blowguns and couplers.

#### Industrial Blowguns

**Polymer** P. 7-3

**Metal** P. 7-12



#### Couplers

**C 9000** P. 8-7

**Metal** P. 8-18



# PVC Braided Hose

Parker Legris offers two **grades of PVC** which cover a wide range of industrial applications for the **transportation of various fluids**.

## Product Advantages

### Food-Grade PVC

Monograde tubing reinforced with a braided polyester ply  
 Flexible: space saving during installation  
 Translucent for visual identification:

- of the fluid
- of inner cleanliness
- of fluid flow

Food-grade, without phthalates  
 Silicone-free

### Industrial PVC

Tubing with a braided polyester ply between 2 grades of PVC  
 Resistant to abrasion, impact and crushing  
 Increased durability  
 Lightweight and easy-to-use  
 Silicone-free



**Applications**

Robotics  
 In-Plant Automotive  
 Pneumatics  
 Semi-Conductors  
 Textile  
 Packaging  
 Vacuum

## Technical Characteristics

Hose	Food-Grade PVC	Industrial PVC
Compatible Fluids	Compressed air, other fluids	Compressed air
Working Pressure	0 to 15 bar	0 to 15 bar
Working Temperature	-20°C to +70°C	-25°C to +60°C
Component Materials	Translucent food-grade PVC, phthalate-free with polyester braid	Industrial blue PVC, multi-layer, with polyester braid

### Regulations

#### Food-Grade PVC

FDA: 21 CFR 177.1550  
 RG: 1907/2006 (REACH)  
 RG: 1935/2004  
 DI: 2002/95/EC (RoHS), 2011/65/EC  
 DI: 2007/10/EC (phthalates)

#### Industrial PVC

DI: 97/23/CE (PED)  
 RG: 1907/2006 (REACH)  
 DI: 2002/95/EC (RoHS), 2011/65/EC

Reliable performance is dependent upon the type of fluid conveyed and fittings being used.

### Hose Performance

#### Food-Grade PVC

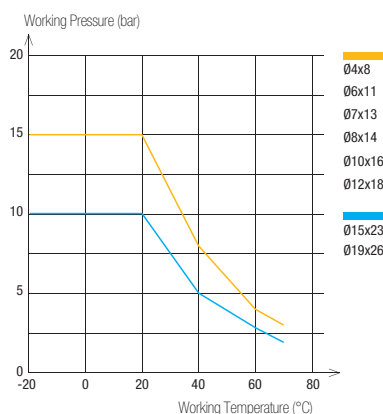

Hose Type	Hose I.D.	Hose I.D. Tolerance
Food-Grade PVC	4 to 6 mm	+0.5 / -0.5
	7 to 12 mm	+0.6 / -0.6
	15 to 19 mm	+0.8 / -0.8
Industrial PVC	6.3 mm	+0.3 / -0.3
	9 mm	+0.5 / -0.5
	12.7 mm	+0.6 / -0.6

#### Packaging



Reel: 25 m, 50 m  
 (with protective plastic bag)

To calculate burst pressure, the values in these graphs should be multiplied by 3.  
 The performances of the industrial PVC grade are available upon request.

**1025V**

## Food-Grade Braided PVC Hose



Reel 25 m

Ø ext. (mm)	Ø int. (mm)		 clear	kg
8	4	10	<a href="#">1025V08 00 04</a>	1.260
11	6	12	<a href="#">1025V11 00 06</a>	2.253
13	7	14	<a href="#">1025V13 00 07</a>	3.182
14	8	16	<a href="#">1025V14 00 08</a>	3.434
16	10	25	<a href="#">1025V16 00 10</a>	3.800
18	12	30	<a href="#">1025V18 00 12</a>	4.423
23	15	40	<a href="#">1025V23 00 15</a>	7.300
26	19	60	<a href="#">1025V26 00 19</a>	7.300

**1050V**

## Food-Grade Braided PVC Hose



Reel 50 m

Ø ext. (mm)	Ø int. (mm)		 clear	kg
8	4	10	<a href="#">1050V08 00 04</a>	2.690
11	6	12	<a href="#">1050V11 00 06</a>	4.200
13	7	14	<a href="#">1050V13 00 07</a>	5.966
14	8	16	<a href="#">1050V14 00 08</a>	6.058
16	10	25	<a href="#">1050V16 00 10</a>	6.400
18	12	30	<a href="#">1050V18 00 12</a>	8.250
23	15	40	<a href="#">1050V23 00 15</a>	14.600
26	19	60	<a href="#">1050V26 00 19</a>	14.600

**1025V..C**

## Industrial-Grade Braided PVC Hose



Reel 25 m

Ø ext. (mm)	Ø int. (mm)			kg
11	6.3	45	<a href="#">1025V11C04 06</a>	2.175
14	9	63	<a href="#">1025V14C04 09</a>	3.250
19	12.7	89	<a href="#">1025V19C04 13</a>	4.975

**1050V..C**

## Industrial-Grade Braided PVC Hose

Reel 50 m

Ø ext. (mm)	Ø int. (mm)			kg
11	6.3	45	<a href="#">1050V11C04 06</a>	4.350
14	9	63	<a href="#">1050V14C04 09</a>	6.500
19	12.7	89	<a href="#">1050V19C04 13</a>	9.950

**Related Products**

PVC tubing is designed for use with Parker Legris barb connectors and couplers.

**Couplers**
**C 9000** P. 8-7

**Metal** P. 8-18

**Barb Connectors**
**0191** P. 9-16

**0123** P. 9-10

# Self-Fastening NBR Hose

Parker Legris self-fastening hose is designed according to **CNOMO E07.21.115N\***. This range of hose should be used with Legris barb connectors and provides both the **reliability** of self-fastening technology and **simplicity of installation**.

## Product Advantages

**Exceptional Endurance** | Unsurpassed resistance to repetitive flexing  
Protection against spark and flame  
Abrasion and crush-resistant  
UV-resistant

**Ideal for In-Plant Automotive** | Excellent ozone resistance  
Perfect for cooling systems  
Maximum flow with no pressure drop  
4 colours for immediate circuit identification  
Silicone-free

**Ready-To-Use** | No lubrication, additive (grease, oil, ...etc), or preparation time required  
To connect: push the hose fully home against the fitting shoulder  
To disassemble: cut the hose on the barbed side of the fitting



In-Plant Automotive  
Cooling  
Welding Robots  
Pneumatics  
Industrial Machinery

Applications

## Technical Characteristics

<b>Compatible Fluids</b>	Coolants, compressed air
<b>Working Pressure</b>	0 to 16 bar
<b>Working Temperature</b>	-20°C to +100°C
<b>Component Materials</b>	Nitrile butadiene rubber & textile braid

Reliable performance is dependent upon the type of fluid conveyed and fittings being used.

### Regulations

NFT 46-019-1  
NFT 47 252  
RG: 1907/2006 (REACH)  
DI: 2002/95/EC (RoHS), 2011/65/EC  
CNOMO: E07.21.115N

\*CAUTION: CNOMO certification is valid exclusively for red and green hose, only when connected to Legris' CNOMO-certified barb connectors 0132, 0133 and 0134.

### Performance of Self-Fastening NBR Hose

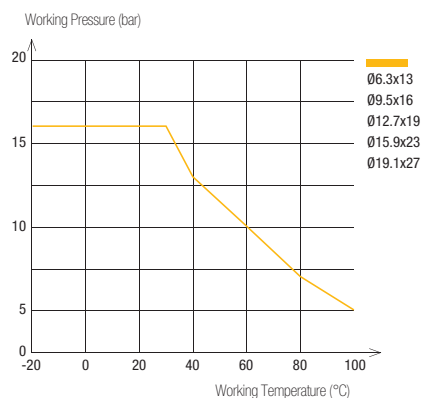

To calculate burst pressure, the values in this graph should be multiplied by 3.

DN mm CNOMO	DN (standard)	Hose I.D. (mm)	Hose I.D. Tolerance (mm)
6	1/4"	6.3 mm	+0.4 / -0.4
8	3/8"	9.5 mm	+0.5 / -0.5
12 16 20	1/2" 5/8" 3/4"	12.7 mm 15.9 mm 19.1 mm	+0.6 / -0.6

Use with water: maximum temperature 100°C  
Use with air: maximum temperature 70°C

### Packaging





Drum: 40 m, 80 m, 100 m



## 1040H

### Braided Self-Fastening NBR Hose

Drum 40 m





DN	Ø ext. (mm)	Ø int. (mm)						kg
1/4	13	6.3	60	1040H56 01	1040H56 02	1040H56 03	1040H56 04	7.000
3/8	16	9.5	70	1040H60 01	1040H60 02	1040H60 03	1040H60 04	8.600
1/2	19	12.7	120	1040H62 01	1040H62 02	1040H62 03	1040H62 04	9.450
5/8	23	15.9	140	1040H66 01	1040H66 02	1040H66 03	1040H66 04	13.000
3/4	27	19.1	170	1040H69 01	1040H69 02	1040H69 03	1040H69 04	16.500

Also available in 20 m length upon request

## 1080H

### Braided Self-Fastening NBR Hose

Drum 80 m





DN	Ø ext. (mm)	Ø int. (mm)						kg
5/8	23	15.9	140	1080H66 01	1080H66 02	1080H66 03	1080H66 04	26.160
3/4	27	19.1	170	1080H69 01	1080H69 02	1080H69 03	1080H69 04	33.160

Also available in 20 m length upon request

## 1100H

### Braided Self-Fastening NBR Hose

Drum 100 m

DN	Ø ext. (mm)	Ø int. (mm)						kg
1/4	13	6.3	60	1100H56 01	1100H56 02	1100H56 03	1100H56 04	14.660
3/8	16	9.5	70	1100H60 01	1100H60 02	1100H60 03	1100H60 04	20.600
1/2	19	12.7	120	1100H62 01	1100H62 02	1100H62 03	1100H62 04	23.000

Also available in 20 m length upon request

## Related Products

Self-fastening hose is designed for use with Parker Legris brass barb connectors (CNOMO-certified).

### Barb Connectors

**0132**

P. 5-25

**0133 .. 39**

P. 5-25

**0134**

P. 5-25



### Installation Tool

**Tool Part Number:**  
**0650 00 00 05**

This automatic installation tool reduces the effort required to connect self-fastening hose onto a barb connector.



#### Tube Cutting and Positioning

Cut the tube at a right angle and position the barb connector on the mounting tool.

Barb connector support



#### Press-Fitting the Tube

Activate the press-fit tool; connection is complete when the tube is fully home on the barb connector.

This tool has been designed for use with 5 different diameters and is easy to operate.

Barb connector support



# Accessories

## 0694 Push-In Fitting with Protection Spring, Male BSPP Thread

Nickel-plated brass, NBR

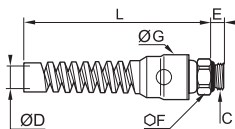

ØD	C		E	F	G	L	kg
8	G1/4	<a href="#">0694 08 13</a>	6.5	16	24	104.5	0.067
10	G1/4	<a href="#">0694 10 13</a>	6.5	18	24	106.5	0.062
12	G3/8	<a href="#">0694 12 17</a>	7.5	20	29.5	126	0.080

## 0695 Push-In Fitting with Protection Spring, Male BSPT Thread

Nickel-plated brass, NBR

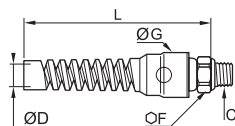

ØD	C		F	G	L	kg
8	R1/4	<a href="#">0695 08 13</a>	14	24	104.5	0.055
10	R1/4	<a href="#">0695 10 13</a>	18	24	106.5	0.064
12	R3/8	<a href="#">0695 12 17</a>	20	29.5	126	0.090

## 3000 71 00 Tube Cutter

Technical polymer

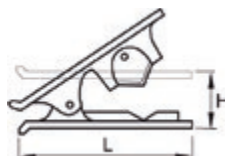

	H	L	kg
<a href="#">3000 71 00</a>	25	79	0.029

This tool is designed to give a clean cut at right angles to the tube axis for all resilient polymer tubing (polyamide, polyurethane, FEP, polyethylene, etc.) from 4 mm to 12 mm diameter inclusive.

Replacement blades: part number 3000 71 00 05

A spring maintains the cutter in the closed position.

## 3000 71 11 Tube Cutter

Treated steel

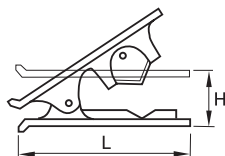

	kg
<a href="#">3000 71 11</a>	0.020

Replacement blades: part number 3000 71 11 05

## 6000 71 00 Stripping Tool for Anti-Spark Tubing

Technical polymer, stainless steel



	kg
<a href="#">6000 71 00</a>	0.098

Working principle of the stripping tool page 3-17

# Accessories

## 1827 Stainless Steel Tube Support for Fluoropolymer Tubing

Stainless steel 316L

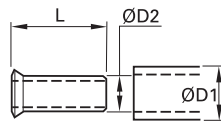

ØD1	ØD2		L	kg
6	4	<a href="#">1827 06 00</a>	11.5	0.001
8	6	<a href="#">1827 08 00</a>	14	0.001
10	8	<a href="#">1827 10 00</a>	18	0.001
12	9	<a href="#">1827 12 09</a>	18	0.001
	10	<a href="#">1827 12 00</a>	18	0.001
16	14	<a href="#">1827 16 00</a>	18	0.002

This tube support is necessary when using fluoropolymer tubing at all temperatures compatible with the fitting/tubing assembly.

## 0127 Brass Tube Support for Polymer Tubing

Brass

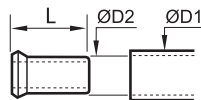

ØD1	ØD2		L	kg
4	2	<a href="#">0127 04 00</a>	11	0.001
	2.7	<a href="#">0127 04 27</a>	11	0.001
5	3	<a href="#">0127 05 03</a>	11	0.001
	3.3	<a href="#">0127 05 00</a>	11.5	0.009
6	4	<a href="#">0127 06 00</a>	11.5	0.001
8	5.5	<a href="#">0127 08 55</a>	14	0.001
	6	<a href="#">0127 08 00</a>	14	0.001
10	7	<a href="#">0127 10 07</a>	18	0.001
	7.5	<a href="#">0127 10 75</a>	18	0.001
12	8	<a href="#">0127 10 00</a>	18	0.002
	8	<a href="#">0127 12 08</a>	18	0.002
	9	<a href="#">0127 12 09</a>	18	0.002
14	10	<a href="#">0127 12 00</a>	18	0.001
	11	<a href="#">0127 14 11</a>	18	0.002
15	12	<a href="#">0127 14 00</a>	18	0.002
16	12	<a href="#">0127 15 12</a>	18	0.002
18	13	<a href="#">0127 16 13</a>	18	0.003
20	14	<a href="#">0127 18 14</a>	19.5	0.003
22	15	<a href="#">0127 20 15</a>	20.5	0.003
25	16	<a href="#">0127 22 16</a>	21	0.004
	19	<a href="#">0127 25 19</a>	25	0.007

This tube support guarantees good gripping, at high temperatures and pressures, by preventing collapsing of the tube.

## CLIP Clip Strip for Tubes and Fittings

Technical polymer

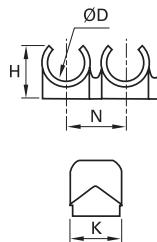

ØD		Number of Outlets	H	K	N	kg
4	<a href="#">CLIP 04 00</a>	8	9	13.5	10.5	0.007
6	<a href="#">CLIP 06 00</a>	8	10.5	13	10.5	0.008
8	<a href="#">CLIP 08 00</a>	7	12.5	10.5	12	0.007
10	<a href="#">CLIP 10 00</a>	6	14	12	15	0.005
12	<a href="#">CLIP 12 00</a>	5	16.5	14	16.5	0.009
14	<a href="#">CLIP 14 00</a>	4	18	16	20.5	0.009

Delivered in boxes of 10 strips of the same diameter (complete with self-tapping screws of 95 mm length) These clips can be used with metric or inch tubing.

## 0697 Clip for Braided Tubing

Treated steel

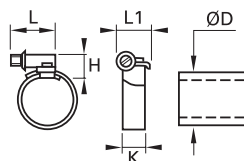

ØD		H	K	L	L1	kg
6-11	<a href="#">0697 00 01</a>	7	5	12	7	0.004
10-16	<a href="#">0697 00 02</a>	12	9	21	13	0.012
12-22	<a href="#">0697 00 03</a>	12	9	21	13	0.014
16-27	<a href="#">0697 00 04</a>	12	9	24	13	0.015
20-32	<a href="#">0697 00 05</a>	12	9	24	13	0.016

# Chemical Compatibility Chart

Recommended	1	Not Recommended	3
Satisfactory	2	Not Available	-

Substances	PA	PU Ether	PU Ester	Low Density PE	Advanced PE	FEP/PFA
Acetaldehyde	1	-	-	3	-	1
Acetone	1	3	1	3	-	1
Acid, chromic up to 10%	-	3	3	1 (50%)	-	1
Acid, citric	3	-	-	1	1 up to 60°C	1
Acid, formic up to 10%	-	2	3	1	1 at 25% at 20°C	1
Acid, hydrochloric up to 10%	1	1	3	1	1 at 20°C	1
Acid, phosphoric up to 50%	3	2	3	1	2 at 20°C	1
Acid, sulphuric up to 10%	3	1	3	1	1	1
Acid, acetic	2 at 10%	1	3	1 (50%)	1 (50 %)	1
Acid, nitric	3	3	3	1 (40%); 3(>40%)	-	1
Ammonia and gaseous	1	1	3	2	1	1
Ammonium chloride up to 10%	-	1	1	1	1	1
Benzene	1	3	3	3	3	1
Bromine	3	-	-	3	3	1
Butane	1	1	1	1 (20°C)	1	1
Butyl acetate	1	3	2	-	-	1
Butylic and butyl alcohol	-	-	-	1 (20°C)	1	1
Calcium choride	-	1 (10% & 40%)	2 (10% & 40%)	1	1	1
Carbon tetrachloride (sodium hypochlorite)	2	3	2	1 (30%)	3	1
Chloroform	3	3	3	3	-	1
Compressed air	1	1	1	1	1	1
Cyclohexanone	1	3	3	3	-	1
Ethanol	1	2	2	3	-	1
Ethyl acetate	1	2	2	2 (20°C)	2 (23°C); 3 (85°C)	1
Ethyl alcohol	-	-	-	3	1 (23°C); 3 (85°C)	1
Ethylene oxide	1	-	-	-	-	1
Formalin (formaldehyde)	2	-	-	1 (40%)	-	1
Freon 12-22	1	2	2	-	-	1
Glucose	1	-	-	-	1	1
Glycol (without H <sub>2</sub> O)	-	1	1	-	-	1
Hydrogen	1	-	-	1	1	1
Hydrogen peroxide (perydrol)	3	2	2	1 (10%)	1	1
Kerosene	1	1	1	-	3	1
Magnesium chloride (up to 30%)	1	1	2	1	1	1
Methane	1	1	1	-	-	1
Methanol	1	2	3	-	-	1
Methyl acetate	-	2	2	-	-	1
Methyl alcohol (pure)	-	-	-	-	2	1

# Chemical Compatibility Chart

Substances	PA	PU Ether	PU Ester	Low Density PE	Advanced PE	FEP/PFA
Methyl chloride	2	3	2	-	-	1
Methyl ethyl ketone	1	3	3	3	-	1
Oils (paraffin)	-	1	1	-	-	1
Oils, engine (diesel)	1	2	1	-	-	1
Oxygen	1	-	1	1 (20°C)	-	1
Ozone	3	2 or 1	1	3	3	1
Perchlorate ethylene	1	3	3	-	-	1
Petrol, with up to 40% aromatics	1	-	2	-	-	1
Petrol, with more than 40% aromatics	1	-	3	-	-	1
Phenols	3	-	3	3	-	1
Potash	-	-	3	1	-	1
Potassium chloride up to 40%	1	1	2	1	-	1
Potassium hydroxide	1 (50%)	1 (3n)	2	1	1	1
Potassium manganate 5%	-	3	2	-	-	1
Potassium sulphate	1	-	-	1	1	1
Propane	1	1	1	-	-	1
Sodium carbonate	1	-	-	1	1	1
Sodium chloride	1 (50%)	1	2	1	-	1
Sodium hydroxide (caustic soda)	1 (60%)	-	-	1	1	1
Sodium hypochlorite (bleach)	1	2	3	1 (30%)	-	1
Tetrachloroethylene	1	2	2	-	-	1
Toluene	1	2	2	3	3	1
Tributylphosphate	1	-	-	-	-	1
Trichlorethylene	1	3	3	3	-	1
Water (distilled, deionised)	-	1	1	-	-	1
Water (drinking, food)	-	-	-	-	1	1
Water (industrial)	1	-	-	-	1	1
Water (sea)	-	-	-	-	-	1
Xylem	-	2	2	-	-	1
Zinc chloride	1 (10%)	-	-	1	-	1

For other fluids, concentrations or special implementation, please contact us.







Function Fittings

**Flow Control Regulators**

**Piloted Function Fittings**

**Non-Return Valves**

LIQUIfit®

**Pressure Fittings**

**Other Function Fittings**

**Silencers**



# Function Fittings

## Flow Control Regulators

[P. 4-6]



**Function:** controls the speed of the cylinder rod  
**Materials:** polymer, metal, stainless steel  
**Pressure:** 10 bar  
**Temperature:** 0°C to +70°C  
 -25°C to +70°C (metal version)  
**Ø metric:** 3 mm to 18 mm  
**Threads:** BSPP, BSPT, metric

## Blocking Fittings

[P. 4-36]



**Function:** provides safety by locking the cylinder piston  
**Materials:** nickel-plated brass, polymer  
**Pressure:** 10 bar  
**Temperature:** -20°C to +70°C  
**Ø metric:** 6 mm to 12 mm  
**Threads:** BSPP, BSPT

## Piloted Non-Return Valves

[P. 4-38]



**Function:** provides safety by locking the cylinder piston  
**Materials:** nickel-plated brass, polymer  
**Pressure:** 10 bar  
**Temperature:** -5°C to +60°C  
**Ø metric:** 6 mm to 12 mm  
**Threads:** BSPP

## Non-Return Valves

[P. 4-40]



**Function:** allows air to pass in one direction only  
**Materials:** polymer, nickel-plated brass  
**Pressure:** 10 bar  
**Temperature:** 0°C to +70°C  
**Ø metric:** 4 mm to 12 mm  
**Threads:** BSPP, BSPT, metric

## Adjustable Non-Return Valves

[P. 4-42]



**Function:** allows air to pass in one direction with an adjustable opening pressure  
**Materials:** FDA chemical nickel-plated brass  
**Pressure:** 12 bar  
**Temperature:** -20°C to +80°C  
**Threads:** BSPP, metric

## LIQUIFIT® Non-Return Valves

[P. 4-44]



**Function:** allows fluid to pass in one direction only  
**Materials:** polymer for food applications  
**Pressure:** 10 bar  
**Temperature:** 0°C to +65°C  
**Ø inch:** 1/4" to 1/2"

## Stainless Steel Non-Return Valves

[P. 4-46]



**Function:** allows fluid to pass in one direction only  
**Materials:** stainless steel  
**Pressure:** 0.5 to 40 bar  
**Temperature:** -20°C to +180°C  
**DN** : 10 mm to 25 mm  
**Threads:** BSPP, NPT

## Soft Start Fittings

[P. 4-48]



**Function:** protects the installation at start-up  
**Materials:** polymer, nickel-plated brass  
**Pressure:** 3 to 10 bar  
**Temperature:** -15°C to +60°C  
**Ø metric** : 8 mm to 12 mm  
**Threads:** BSPP

## Pneumatic Sensor Fittings

[P. 4-50]



**Function:** pneumatic or electric output signal, detects end of cylinder rod stroke  
**Materials:** polymer, treated metal  
**Pressure:** 3 to 8 bar  
**Temperature:** -15°C to +60°C  
**Ø metric:** 4 mm  
**Threads:** BSPP, metric

# Function Fittings

## Pressure Regulators (P. 4-52)



**Function:** stabilise the maximum pressure delivered to pneumatic equipment

**Materials:** polymer, treated metal

**Pressure:** 16 bar (upstream), 8 bar (downstream)

**Temperature:** -10°C to +70°C

**Ø metric:** 4 mm to 10 mm

**Threads:** BSPP

## Pressure Reducers (P. 4-54)



**Function:** set the maximum pressure delivered to pneumatic equipment

**Materials:** polymer, treated metal

**Pressure:** 8 bar

**Temperature:** -15°C to +60°C

**Ø metric:** 6 mm to 10 mm

**Threads:** BSPP

## Snap Connectors (P. 4-56)



**Function:** isolates a circuit without venting the whole system

**Materials:** polymer, nickel-plated brass

**Pressure:** 10 bar

**Temperature:** -20°C to +80°C

**Ø DN:** 5 mm to 7 mm

**Threads:** BSPP

## Manually-Operated Valves (P. 4-58)



**Function:** opens/closes a circuit, with or without venting

**Materials:** polymer, nickel-plated brass, aluminium

**Pressure:** 10 bar, 16 bar (0669)

**Temperature:** -10°C to +80°C, -5°C to +70°C (0669)

**Ø metric:** 4 mm to 10 mm

**Threads:** BSPP, metric

## Metal Quick Exhaust Valves (P. 4-60)



**Function:** increases the return speed of the cylinder

**Materials:** nickel-plated brass, aluminium, stainless steel

**Pressure:** 10 bar

**Temperature:** -20°C to +70°C

**Threads:** BSPP, BSPT, metric

## Silencers (P. 4-62)



**Function:** reduces noise levels

**Materials:** sintered bronze, polyethylene, stainless steel, nickel-plated brass

**Pressure:** 12 bar

**Temperature:** -20°C to +180°C







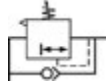

**Ø metric:** 4 mm to 12 mm

**Threads:** BSPP, metric, NPT

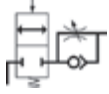
# Selecting your Function Fitting

<b>Protect Your System</b>	<b>Blocking Fittings</b>	Maintain the load following an emergency stop of a pneumatic system.	Models <b>7880 - 7881 - 7883 - 7885 7886</b>
	<b>Soft Start Fittings</b>	Increase the pressure gradually in order to protect it from potentially damaging shock when a pneumatic system is restarted.	Models <b>7860 - 7861 - 7870 - 7871</b>
	<b>Non-Return Valves</b>	Allow compressed air or fluids to flow in one direction, and prevent it from flowing in the other. If the supply is accidentally shut off, the air can only escape in one direction.	Models <b>4890 - 4891 - 4892 - 4895 7930 - 7931 - 7932 - 7984 7985 - 7992 - 7994 - 7995 7996</b>
	<b>Piloted Non-Return Valves</b>	Incorporate 3 functions into one product to protect your system: piloted non-return valve, flow control regulator and manual vent.	Models <b>7892 - 7894</b>
<b>Detect End of Cylinder Rod Stroke</b>	<b>Pneumatic Sensor Fittings</b>	Detect the back pressure drop at the end of stroke to produce a signal (pneumatic or electronic) to allow reciprocation.	Models <b>7818 - 7828</b>
<b>Control and Improve the Performance of Your System</b>	<b>Pressure Regulators</b>	Regulate and stabilise the pressure at a maximum determined value whatever the upstream pressure.	Models <b>7300</b>
	<b>Pressure Reducer Fittings</b>	Reduce the pressure consumed in one section of the machine in order to save energy.	Models <b>7316 - 7318 - 7416 - 7471</b>
	<b>Quick Exhaust Valves</b>	Increase the return speed of the cylinder by discharging the exhaust directly to atmosphere.	Models <b>7899 - 7970 - 7971</b>
	<b>Silencers</b>	Reduce the noise levels whilst air is vented from a compressed air system.	Models <b>0670 - 0671 - 0672 - 0673 0674 - 0675 - 0676 - 0677</b>
<b>Working on Your System</b>	<b>Snap Fittings</b>	Allow a circuit to be isolated without fully venting the system.	Models <b>7921 - 7926 - 7960 - 7961</b>
	<b>Manually-Operated Valves</b>	Allow for repeated venting by simply moving the valve sleeve or the manually-operated valve lever.	Models <b>0669 - 7800 - 7801 - 7802</b>

# Symbols for Function Fittings

<p><b>Regulating</b> air flow</p> 	<p><b>Regulating</b> pressure by stabilising at a required value</p> 
<p><b>Blocking</b> air circulation</p> 	<p><b>Reducing</b> pressure supply</p> 
<p><b>Blocking</b> and <b>regulating</b> air flow</p> 	<p><b>Progressive</b> pressurising of circuits</p> 
<p><b>Controlling</b> allows the passage of fluid in one direction and prevents it in the other</p> 	<p><b>Isolating a circuit</b> without venting the entire system</p> 
<p><b>Exhausting system</b> and <b>controlling</b> pneumatic circuit supply</p> 	<p><b>Regulating, blocking and venting</b> to protect the system and individuals</p> 
<p><b>Detecting</b> pressure drop</p> 	

# Selecting Your Flow Control Regulator

The comprehensive range of Parker Legris flow control regulators provides a solution for all flow regulation functions in a pneumatic system.

Select the model suited to your application according to:

## 5 Key Requirements

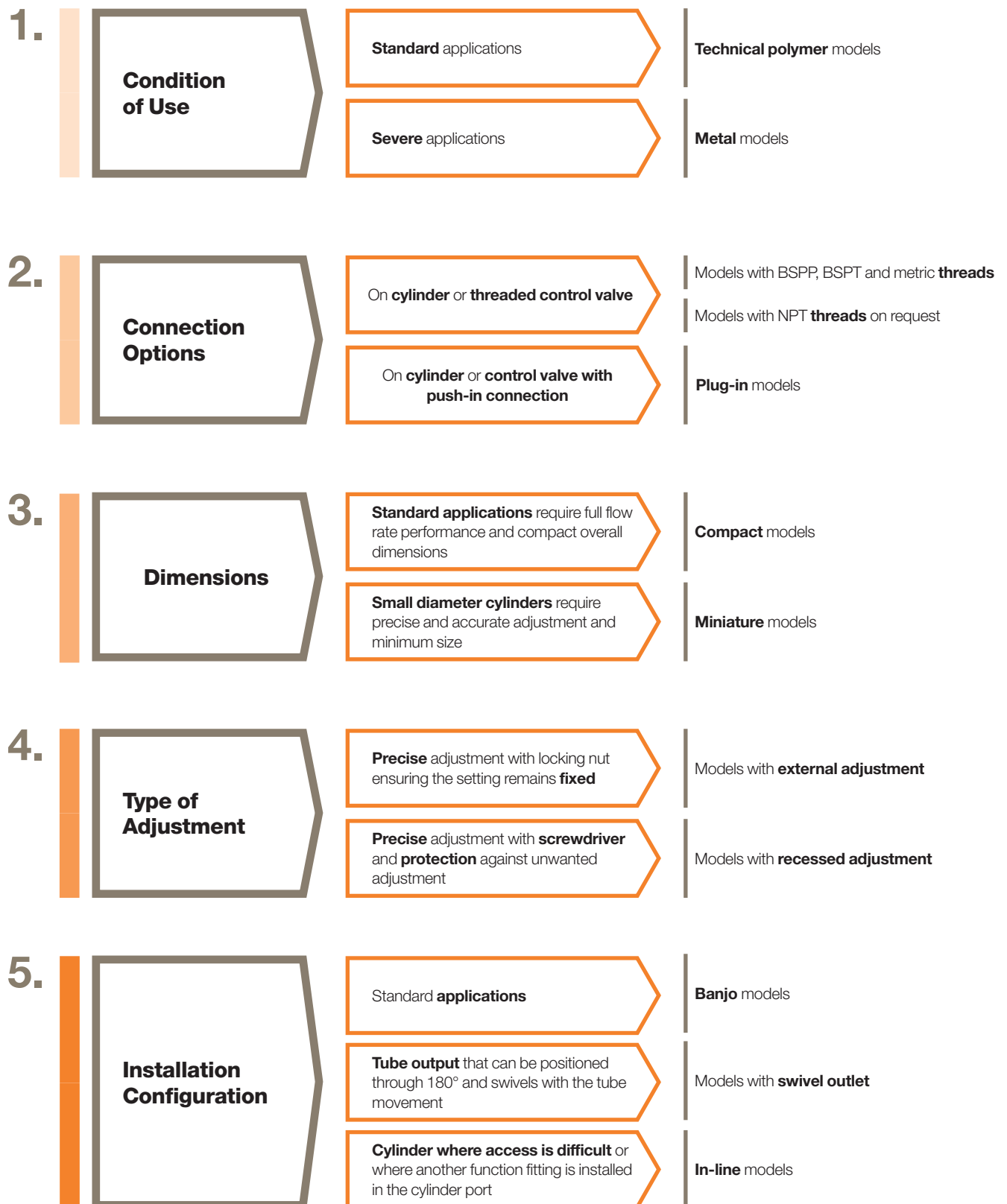

# Flow Control Regulator Range

## Technical Polymer Version, BSPP and Metric

### Recessed Adjustment

**7010**  
**7011**  
**7012**  
Push-In  
Page 4-10



### External Adjustment

**7060**  
**7061**  
**7062**  
Compact  
Push-In  
Page 4-11/12



**7660**  
**7662**  
**7669**  
Miniature  
Push-In  
Page 4-13/14



### Swivel Outlet

**7040**  
**7041**  
Compact  
Push-In  
Page 4-14



**7640**  
**7649**  
Miniature  
Push-In  
Page 4-15



### In-Line

**7770**  
**7772**  
Push-In  
Page 4-16



**7776**  
Bulkhead  
Push-In  
Page 4-16



**7771**  
Threaded  
Page 4-16



**7020**  
Straight  
Push-In  
Page 4-17



**7000**  
Page 4-16



### Plug-In

**7030**  
**7031**  
Compact  
Push-In  
Page 4-18



**7630**  
**7631**  
Miniature  
Push-In  
Page 4-18



## Technical Polymer Version, BSPT

### External Adjustment

**7065**  
**7066**  
**7067**  
Compact  
Push-In  
Page 4-11/12



**7665**  
**7668**  
Miniature  
Push-In  
Page 4-13



### Swivel Outlet and External Adjustment

**7045**  
Compact  
Push-In  
Page 4-14



**7645**  
Miniature  
Push-In  
Page 4-15



## Brass, Nickel-Plated Brass and Aluminium Versions, BSPP and Metric

### Recessed Adjustment

**7130**  
Push-In  
Page 4-19



**7140**  
Threaded  
Page 4-19



**7160**  
Compression  
Page 4-19



### In-Line

**7170**  
Bulkhead  
Threaded  
Page 4-21



### External Adjustment

**7762**  
Compression  
Page 4-21



**7100**  
**7101**  
Compact  
Push-In  
Page 4-20



**7680**  
Compact  
Push-In  
Page 4-20



**7180**  
Miniature  
Push-In  
Page 4-20

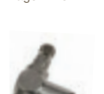

**7110**  
**7111**  
Compact  
Threaded  
Page 4-20/21



**7190**  
Miniature  
Threaded  
Page 4-21



## Stainless Steel Versions

**7810**  
**7812**  
Threaded  
Page 4-23



**7820**  
**7822**  
Threaded  
Page 4-23





# Flow Control Regulators

Parker Legris flow control regulators with polymer, nickel-plated brass or aluminium bodies, external or recessed adjustment screws, offer **precise adjustment, accuracy** and **compactness** providing the solution for all applications.

## Product Advantages

### Improved Productivity

- Higher maximum flow than standard regulators
- Full flow with minimum pressure drop (model 7060)
- Optimal control of the cylinder rod speed
- 100% leak-tested in production
- Date coding to guarantee quality and traceability
- Reduce compressed air and energy consumption

### Accuracy & Performance

- Precise adjustment for accurate flow regulation from initial to maximum opening
- Constant cylinder rod displacement speed
- Long-term stability of flow
- Reduced weight (polymer version)
- Mechanical strength and corrosion resistance with nickel-plated brass version

### Ergonomics & Large Range

- External adjustment screw: easy to adjust without tooling and lockable
- Recessed adjustment screw: more compact and protects the adjustment mechanism
- Uni-directional: exhaust or inlet
- Bi-directional: adjustment of air flow in both directions
- 360° positioning
- NPT version on request



Pneumatics  
Robotics  
Semi-Conductors  
Railway  
Textile  
Automotive Process  
Packaging

Applications

## Technical Characteristics

<b>Compatible Fluids</b>	Compressed air Other fluids: contact us
<b>Working Pressure</b>	1 to 10 bar
<b>Working Temperature</b>	0°C to +70°C -25°C to +70°C (metal version)

<b>Max. Tightening Torques (external adjustment screw)</b>	Threads	M3 x0.5	M5 x0.8	G1/8	G1/4	G3/8	G1/2
	daN.m	0.06	0.16	0.8	1.2	3	3.5
<b>Max. Tightening Torques (recessed adjustment screw)</b>	Threads	-	M5 x0.8	G1/8	G1/4	G3/8	G1/2
	daN.m	-	0.1	0.4	0.5	0.6	0.7

Reliable performance is dependent upon the type of fluid conveyed and component materials being used.

Use is guaranteed with a vacuum of 755 mm Hg (99% vacuum).

You will find all the flow rate characteristic curves (to 6 bar) for flow control regulators at the end of the chapter.

### Component Materials

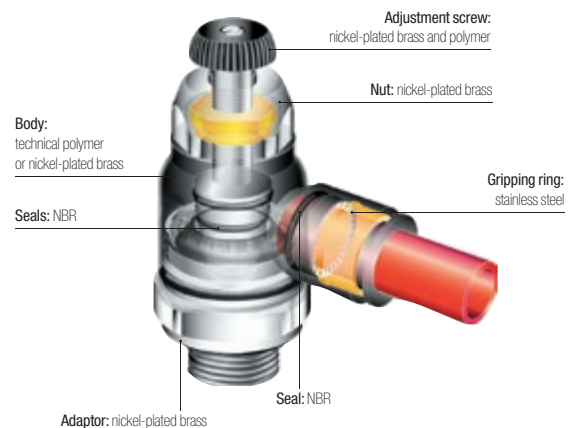

### Silicone-free

### Regulations

EN 45545 - Railway applications - Fire protection on railway (metal version)  
 DI: 2002/95/EC (RoHS)  
 RG: 1907/2006 (REACH)  
 DI: 97/23/EC (PED)

# Flow Control Regulators

## Operation

Parker Legris offers both uni-directional and bi-directional flow control regulators.

The uni-directional models control the flow of air in one direction through an adjustable restrictor, while allowing full flow in the opposite direction.

The bi-directional models control the flow of air in both directions.

A more precise and constant flow regulation is obtained when the regulator is fitted directly onto the cylinder.

### Models with Recessed Adjustment

#### Uni-Directional (Exhaust Version)

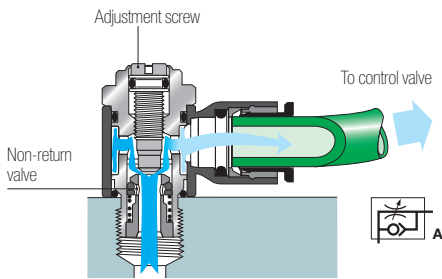

#### Uni-Directional (Supply Version)

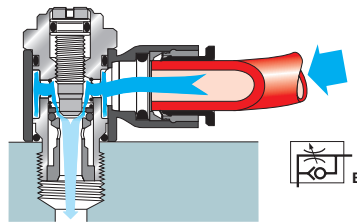

#### Bi-Directional Version

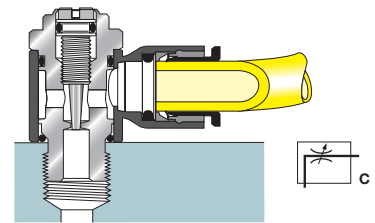

### Models with External Adjustment

#### Uni-Directional (Exhaust Version)

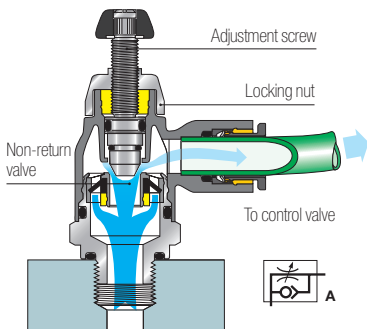

#### Uni-Directional (Supply Version)

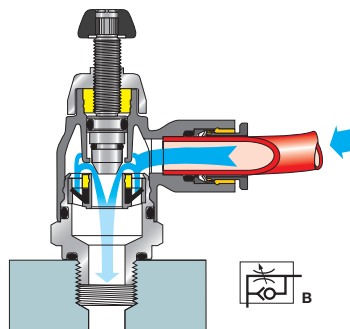

#### Bi-Directional Version

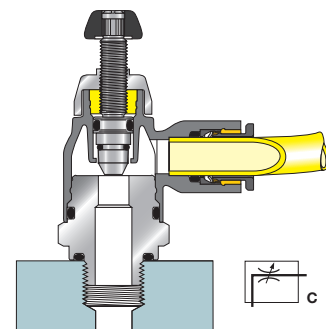

### In-Line Models

#### Uni-Directional Version

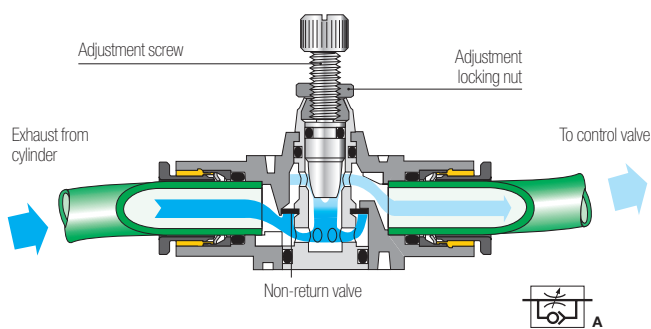

#### Bi-Directional Version

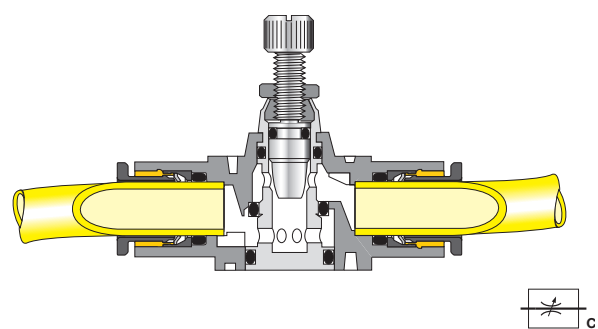

For instant visual identification, each Parker Legris flow control regulator version is identified by the related pneumatic symbol and by a letter:

- uni-directional regulation on exhaust: letter A
- uni-directional regulation on supply: letter B
- bi-directional regulation: letter C

# Regulators with Recessed Adjustment

## 7010 Flow Regulator with Recessed Adjustment Screw Exhaust, Male BSPP and Metric Thread

Technical polymer, nickel-plated brass, NBR

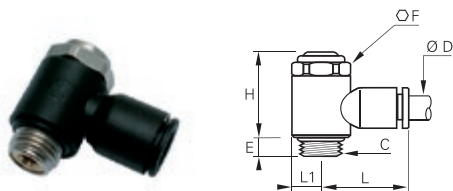

ØD	C		E	F	H	L	L1	Kg
4	M5x0.8	<a href="#">7010 04 19</a>	4	8	17.5	17	5	0.006
	G1/8	<a href="#">7010 04 10</a>	5	13	25	19	7	0.017
6	M5x0.8	<a href="#">7010 06 19</a>	4	8	17.5	19	5	0.006
	G1/8	<a href="#">7010 06 10</a>	5	13	25	21	7	0.018
8	G1/4	<a href="#">7010 06 13</a>	8	17	26.5	22	9.5	0.034
	G1/8	<a href="#">7010 08 10</a>	5	13	25	26	7	0.019
8	G1/4	<a href="#">7010 08 13</a>	8	17	26.5	27	9.5	0.035
	G3/8	<a href="#">7010 08 17</a>	7.5	20	37.5	29	11	0.068
10	G1/4	<a href="#">7010 10 13</a>	8	17	26.5	29	9.5	0.035
	G3/8	<a href="#">7010 10 17</a>	7.5	20	37.5	31	11	0.067
12	G1/2	<a href="#">7010 10 21</a>	8	23	43	37	13.5	0.117
	G3/8	<a href="#">7010 12 17</a>	7.5	20	37.5	34.5	11	0.069
	G1/2	<a href="#">7010 12 21</a>	8	23	43	37	13.5	0.108

## 7011 Flow Regulator with Recessed Adjustment Screw Supply, Male BSPP and Metric Thread

Technical polymer, nickel-plated brass, NBR

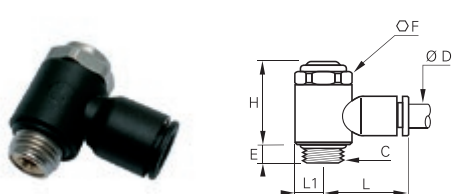

ØD	C		E	F	H	L	L1	Kg
4	M5x0.8	<a href="#">7011 04 19</a>	4	8	17.5	17	5	0.006
	G1/8	<a href="#">7011 04 10</a>	5	13	25	19	7	0.017
6	M5x0.8	<a href="#">7011 06 19</a>	4	8	17.5	19	5	0.006
	G1/8	<a href="#">7011 06 10</a>	5	13	25	21	7	0.018
8	G1/4	<a href="#">7011 06 13</a>	8	17	26.5	22	9.5	0.034
	G1/8	<a href="#">7011 08 10</a>	5	13	25	26	7	0.019
8	G1/4	<a href="#">7011 08 13</a>	8	17	26.5	27	9.5	0.034
	G3/8	<a href="#">7011 08 17</a>	7.5	20	37.5	29	11	0.067
10	G1/4	<a href="#">7011 10 13</a>	8	17	26.5	29	9.5	0.036
	G3/8	<a href="#">7011 10 17</a>	7.5	20	37.5	31	11	0.068

## 7012 Bi-Directional Flow Regulator with Recessed Adjustment Screw Male BSPP and Metric Thread

Technical polymer, nickel-plated brass, NBR

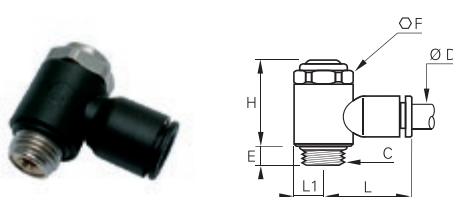

ØD	C		E	F	H	L	L1	Kg
4	M5x0.8	<a href="#">7012 04 19</a>	4	8	17.5	17	5	0.006
	G1/8	<a href="#">7012 04 10</a>	5	13	25	19	7	0.018
6	M5x0.8	<a href="#">7012 06 19</a>	4	8	17.5	19	5	0.006
	G1/8	<a href="#">7012 06 10</a>	5	13	25	21	7	0.019
8	G1/4	<a href="#">7012 06 13</a>	8	17	26.5	22	9.5	0.035
	G1/8	<a href="#">7012 08 10</a>	5	13	25	26	7	0.019
8	G1/4	<a href="#">7012 08 13</a>	8	17	26.5	27	9.5	0.036
	G3/8	<a href="#">7012 08 17</a>	7.5	20	37.5	29	11	0.071

Each pneumatic function fitting is identified by:

- the item type
- the tube outside diameter
- the thread or 2<sup>nd</sup> tube outside diameter

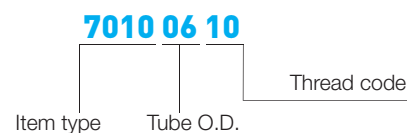

# Compact Regulators with External Adjustment

## 7060 Compact Flow Regulator Exhaust, Male BSPP Thread



Technical polymer, nickel-plated brass, NBR

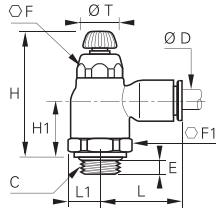

ØD	C		E	F	F1	H	H <sub>max</sub>	H1	L	L1	ØT	Kg
4	G1/8	<a href="#">7060 04 10</a>	5	10	16	38	44	16	22	9	10	0.020
	G1/8	<a href="#">7060 06 10</a>	5	10	16	38	44	16	22	9	10	0.020
6	G1/4	<a href="#">7060 06 13</a>	5.5	10	16	36.5	42.5	15	22	9	10	0.020
	G1/8	<a href="#">7060 08 10</a>	4.5	14	19	41.5	48	18	28	10.5	14	0.032
8	G1/4	<a href="#">7060 08 13</a>	5.5	14	19	41.5	48	18.5	28	10.5	14	0.034
	G3/8	<a href="#">7060 08 17</a>	5.5	14	19	41.5	48	17	28	11	14	0.034
10	G1/4	<a href="#">7060 10 13</a>	5.5	17	23	45.5	53.5	20	31.5	12.5	17	0.053
	G3/8	<a href="#">7060 10 17</a>	5.5	17	23	45.5	54	20	31.5	12.5	17	0.054
12	G3/8	<a href="#">7060 12 17</a>	5.5	17	23	45.5	54	20	35	12.5	17	0.056
	G1/2	<a href="#">7060 12 21</a>	7.5	17	24	45.5	54	20	35	13	17	0.058

## 7065 Compact Flow Regulator Exhaust, Male BSPT Thread



Technical polymer, nickel-plated brass, NBR

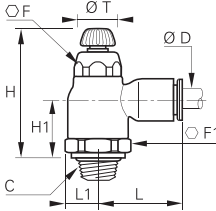

ØD	C		F	F1	H <sub>min</sub>	H <sub>max</sub>	H1	L	L1	ØT	Kg
6	R1/8	<a href="#">7065 06 10</a>	10	16	36.5	42.5	15	22	8	10	0.021
	R1/8	<a href="#">7065 08 10</a>	14	19	40	45	16.5	28	10.5	14	0.034
8	R1/4	<a href="#">7065 08 13</a>	14	19	40	45	16.5	28	10.5	14	0.036
	R1/4	<a href="#">7065 10 13</a>	17	23	43.5	51.5	18	31.5	12.5	17	0.053
10	R3/8	<a href="#">7065 10 17</a>	17	23	43.5	51.5	18	31.5	12.5	17	0.055
	R1/2	<a href="#">7065 10 21</a>	17	23	43.5	51.5	18	31.5	12.5	17	0.059
12	R1/4	<a href="#">7065 12 13</a>	17	23	43.5	51.5	18	35	12.5	17	0.056
	R3/8	<a href="#">7065 12 17</a>	17	23	43.5	51.5	18	35	12.5	17	0.059
	R1/2	<a href="#">7065 12 21</a>	17	23	43.5	51.5	18	35	12.5	17	0.064

Pre-coated thread

## 7061 Compact Flow Regulator Supply, Male BSPP Thread



Technical polymer, nickel-plated brass, NBR

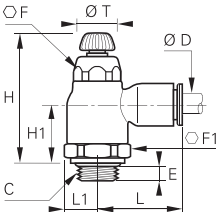

ØD	C		E	F	F1	H	H <sub>max</sub>	H1	L	L1	ØT	Kg
4	G1/8	<a href="#">7061 04 10</a>	5	10	16	38	44	16	22	9	10	0.020
	G1/8	<a href="#">7061 06 10</a>	5	10	16	38	44	16	22	9	10	0.020
6	G1/4	<a href="#">7061 06 13</a>	5.5	10	16	36.5	42.5	15	22	9	10	0.021
	G1/8	<a href="#">7061 08 10</a>	4.5	14	19	41.5	48	18	28	10.5	14	0.033
8	G1/4	<a href="#">7061 08 13</a>	5.5	14	19	41.5	48	18.5	28	10.5	14	0.034
	G3/8	<a href="#">7061 08 17</a>	5.5	14	23	41.5	48	17	28	11	14	0.033
10	G1/4	<a href="#">7061 10 13</a>	5.5	17	23	45.5	53.5	20	31.5	12.5	17	0.053
	G3/8	<a href="#">7061 10 17</a>	5.5	17	23	45.5	54	20	31.5	12.5	17	0.054
12	G1/2	<a href="#">7061 12 21</a>	7.5	17	24	45.5	54	20	35	13	17	0.060

## 7066 Compact Flow Regulator Supply, Male BSPT Thread



Technical polymer, nickel-plated brass, NBR

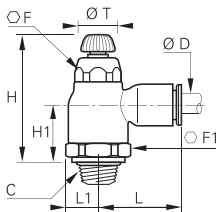

ØD	C		F	F1	H <sub>min</sub>	H <sub>max</sub>	H1	L	L1	ØT	Kg
10	R1/4	<a href="#">7066 10 13</a>	17	23	43.5	51.5	18	31.5	12.5	17	0.020
	R3/8	<a href="#">7066 10 17</a>	17	23	43.5	51.5	18	31.5	12.5	17	0.020
12	R1/2	<a href="#">7066 10 21</a>	17	23	43.5	51.5	18	31.5	12.5	17	0.059
	R1/4	<a href="#">7066 12 13</a>	17	23	43.5	51.5	18	35	12.5	17	0.056
12	R3/8	<a href="#">7066 12 17</a>	17	23	43.5	51.5	18	35	12.5	17	0.059
	R1/2	<a href="#">7066 12 21</a>	17	23	43.5	51.5	18	35	12.5	17	0.064

Pre-coated thread

# Compact Regulators with External Adjustment

## 7062 Bi-Directional Compact Flow Regulator, Male BSPP Thread



Technical polymer, nickel-plated brass, NBR

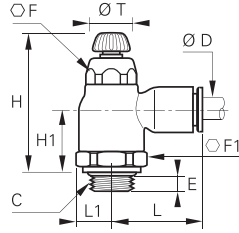

ØD	C		E	F	F1	H	H <sub>max</sub>	H1	L	L1	ØT	Kg
4	G1/8	<a href="#">7062 04 10</a>	5	10	16	38	44	16	22	9	10	0.025
	G1/8	<a href="#">7062 06 10</a>	5	10	16	38	44	16	22	9	10	0.025
6	G1/4	<a href="#">7062 06 13</a>	5.5	10	16	36.5	42.5	15	22	9	10	0.025
	G1/8	<a href="#">7062 08 10</a>	4.5	14	19	41.5	48	18	28	10.5	14	0.043
8	G1/4	<a href="#">7062 08 13</a>	5.5	14	19	41.5	48	18.5	28	10.5	14	0.046
	G3/8	<a href="#">7062 08 17</a>	5.5	14	19	41.5	48	17	28	11	14	0.042

## 7067 Bi-Directional Compact Flow Regulator, Male BSPT Thread



Technical polymer, nickel-plated brass, NBR

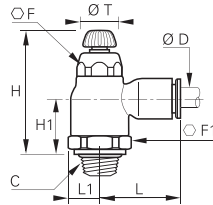

ØD	C		F	F1	H <sub>min</sub>	H <sub>max</sub>	H1	L	L1	ØT	Kg
4	R1/8	<a href="#">7067 04 10</a>	10	16	36.5	42.5	14.7	22	9	10	0.025
	R1/8	<a href="#">7067 06 10</a>	10	16	36.5	42.5	14.7	22	9	10	0.010
6	R1/4	<a href="#">7067 06 13</a>	10	16	36.5	42.5	14.7	22	9	10	0.014
	R1/8	<a href="#">7067 08 10</a>	14	19	40	45	16.5	28	10.5	14	0.034
8	R1/4	<a href="#">7067 08 13</a>	14	19	40	45	16.5	28	10.5	14	0.036
	R3/8	<a href="#">7067 08 17</a>	14	19	40	45	16.5	28	11	14	0.042

Pre-coated thread

# Miniature Regulators with External Adjustment

## 7660

### Miniature Flow Regulator Exhaust, Male BSPP and Metric Thread



Technical polymer, nickel-plated brass, NBR

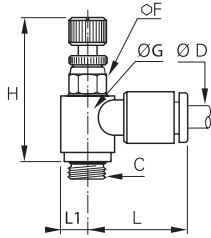

ØD	C		F	G	H <sub>min</sub>	H <sub>max</sub>	L	L1	Kg
3	M3x0.5	<a href="#">7660 03 09</a>	6	9	23.5	26	17	4.5	0.007
	M5x0.8	<a href="#">7660 03 19</a>	6	9	23.5	26	17	4.5	0.006
4	M3x0.5	<a href="#">7660 04 09</a>	6	9	23.5	26	16.5	4.5	0.007
	M5x0.8	<a href="#">7660 04 19</a>	6	9	23.5	26	17	4.5	0.006
6	G1/8	<a href="#">7660 04 10</a>	7	11.5	27	29.5	18	6	0.012
	M5x0.8	<a href="#">7660 06 19</a>	6	9	23.5	26	18	4.5	0.006
8	G1/8	<a href="#">7660 06 10</a>	7	11.5	27	29.5	18.5	6	0.012
	G1/4	<a href="#">7660 06 13</a>	8	12	30	32.5	19	6	0.019
8	G1/8	<a href="#">7660 08 10</a>	13	14	26.5	31	26	7	0.021
	G1/4	<a href="#">7660 08 13</a>	16	19	29	34	27.5	9.5	0.033
	G3/8	<a href="#">7660 08 17</a>	20	23	36	42	29	11.5	0.061

## 7665

### Miniature Flow Regulator Exhaust, Male BSPT Thread



Technical polymer, nickel-plated brass, NBR

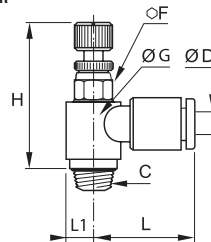

ØD	C		F	G	H <sub>min</sub>	H <sub>max</sub>	L	L1	Kg
4	R1/8	<a href="#">7665 04 10</a>	7	11.5	25	27.5	18	6	0.012
	R1/8	<a href="#">7665 06 10</a>	7	11.5	25	27.5	18.5	6	0.012
6	R1/4	<a href="#">7665 06 13</a>	8	13.5	27.5	30	19	7	0.019
	R3/8	<a href="#">7665 06 17</a>	17	13.5	31.5	34	19	7	0.025
8	R1/8	<a href="#">7665 08 10</a>	13	14	24	28.5	26	7	0.021
	R1/4	<a href="#">7665 08 13</a>	16	19	25	29	27.5	9.5	0.033
	R3/8	<a href="#">7665 08 17</a>	20	23	30	36	29	11.5	0.061

Pre-coated thread

## 7669

### Miniature Flow Regulator Supply, Male BSPP and Metric Thread



Technical polymer, nickel-plated brass, NBR

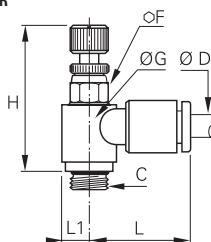

ØD	C		F	G	H <sub>min</sub>	H <sub>max</sub>	L	L1	Kg
3	M3x0.5	<a href="#">7669 03 09</a>	6	9	23.5	26	17	4.5	0.008
	M5x0.8	<a href="#">7669 03 19</a>	6	9	23.5	26	17	4.5	0.007
4	M5x0.8	<a href="#">7669 04 19</a>	6	9	23.5	26	17	4.5	0.006
	G1/8	<a href="#">7669 04 10</a>	7	11.5	27	29.5	18	6	0.012
6	M5x0.8	<a href="#">7669 06 19</a>	6	9	23.5	26	18	4.5	0.007
	G1/8	<a href="#">7669 06 10</a>	7	11.5	27	29.5	18.5	6	0.013
8	G1/4	<a href="#">7669 06 13</a>	8	12	30	32.5	19	6	0.019
	G1/8	<a href="#">7669 08 10</a>	13	14	26.5	31	26	7	0.021
8	G1/4	<a href="#">7669 08 13</a>	16	19	29	34	27.5	9.5	0.033
	G3/8	<a href="#">7669 08 17</a>	20	23	36	42	29	11.5	0.063

## 7668

### Miniature Flow Regulator Supply, Male BSPT Thread



Technical polymer, nickel-plated brass, NBR

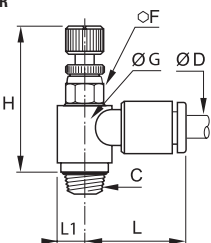

ØD	C		F	G	H <sub>min</sub>	H <sub>max</sub>	L	L1	Kg
4	R1/8	<a href="#">7668 04 10</a>	7	11.5	25	27.5	18	6	0.011
	R1/8	<a href="#">7668 06 10</a>	7	11.5	25	27.5	18.5	6	0.012
6	R1/4	<a href="#">7668 06 13</a>	8	13.5	27.5	30	19	7	0.019
	R1/8	<a href="#">7668 08 10</a>	13	14	24	28.5	26	7	0.020
8	R1/4	<a href="#">7668 08 13</a>	16	19	25	29	27.5	9.5	0.032
	R3/8	<a href="#">7668 08 17</a>	20	23	30	36	29	11.5	0.061

Pre-coated thread

# Regulators with External Adjustment

**7662**

Bi-Directional Miniature Flow Regulator, Male BSPP and Metric Thread



Technical polymer, nickel-plated brass, NBR

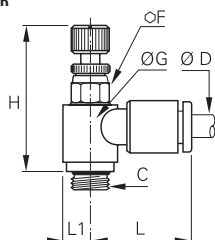

ØD	C		F	G	H <sub>min</sub>	H <sub>max</sub>	L	L1	Kg
4	M5x0.8	<a href="#">7662 04 19</a>	6	9	23.5	26	17	4.5	0.007
	G1/8	<a href="#">7662 04 10</a>	7	11.5	27	29.5	18	6	0.013
6	M5x0.8	<a href="#">7662 06 19</a>	6	9	23.5	26	18	4.5	0.010
	G1/8	<a href="#">7662 06 10</a>	7	11.5	27	29.5	18.5	6	0.013
	G1/4	<a href="#">7662 06 13</a>	8	12	30	32.5	19	6	0.019

**7040**

Compact Flow Regulator Swivel Outlet Exhaust, Male BSPP Thread



Technical polymer, nickel-plated brass, NBR

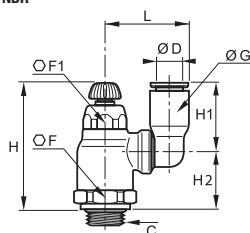

ØD	C		F	F1	G	H <sub>min</sub>	H <sub>max</sub>	H1	H2	L	Kg
6	G1/8	<a href="#">7040 06 10</a>	16	10	10.5	38	44	16	18	23.5	0.024
	G1/4	<a href="#">7040 06 13</a>	16	10	10.5	36.5	42.5	16	16.5	23.5	0.025
	G1/8	<a href="#">7040 08 10</a>	19	14	13.5	41.5	48	23	19	28	0.037
8	G1/4	<a href="#">7040 08 13</a>	19	14	13.5	41.5	48	23	19.5	28	0.039
	G3/8	<a href="#">7040 08 17</a>	19	14	13.5	41.5	48	23	17.5	28	0.020
10	G1/4	<a href="#">7040 10 13</a>	23	17	16	45.5	53.5	26.5	21	35	0.051
	G3/8	<a href="#">7040 10 17</a>	23	17	16	45.5	54	26.5	21.5	35	0.063
12	G3/8	<a href="#">7040 12 17</a>	23	17	19	45.5	54	30.5	21.5	38	0.066
	G1/2	<a href="#">7040 12 21</a>	24	17	19	45.5	54	30.5	21	38	0.071

**7045**

Compact Flow Regulator Swivel Outlet Exhaust, Male BSPT Thread



Technical polymer, nickel-plated brass, NBR

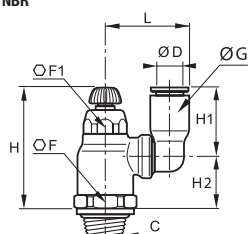

ØD	C		F	F1	G	H <sub>min</sub>	H <sub>max</sub>	H1	H2	L	Kg
6	R1/4	<a href="#">7045 06 13</a>	16	10	10.5	36.5	42.5	16	16.5	23.5	0.030
	R1/8	<a href="#">7045 08 10</a>	19	14	13.5	40	46	23	17	28	0.014
8	R1/4	<a href="#">7045 08 13</a>	19	14	13.5	40	46	23	17	28	0.043
	R3/8	<a href="#">7045 08 17</a>	19	14	13.5	40	46	23	17	28	0.044
10	R1/4	<a href="#">7045 10 13</a>	23	17	16	43.5	51.5	26.5	19	35	0.062
	R3/8	<a href="#">7045 10 17</a>	23	17	16	43.5	51.5	26.5	19	35	0.065
12	R3/8	<a href="#">7045 12 17</a>	23	17	19	43.5	51.5	31	19	38	0.065
	R1/2	<a href="#">7045 12 21</a>	23	17	19	43.5	51.5	31	19	38	0.070

Pre-coated thread

**7041**

Compact Flow Regulator Swivel Outlet Supply, Male BSPP Thread



Technical polymer, nickel-plated brass, NBR

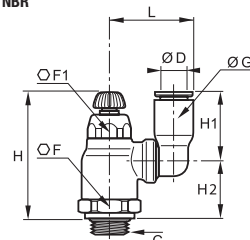

ØD	C		F	F1	G	H <sub>min</sub>	H <sub>max</sub>	H1	H2	L	Kg
6	G1/4	<a href="#">7041 06 13</a>	16	10	10.5	36.5	42.5	16	16.5	23.5	0.024
8	G1/8	<a href="#">7041 08 10</a>	19	14	13.5	41.5	48	23	19	28	0.037
	G1/4	<a href="#">7041 08 13</a>	19	14	13.5	41.5	48	23	19.5	28	0.039



# Miniature Regulators with Swivel Outlet and External Adjustment

## 7640

### Miniature Swivel Outlet Flow Regulator Exhaust, Male BSPP and Metric Thread



Technical polymer, nickel-plated brass, NBR

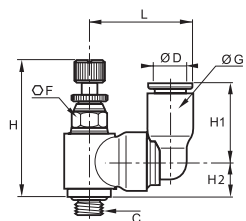

ØD	C		F	G	H <sub>min</sub>	H <sub>max</sub>	H1	H2	L	Kg
4	M5x0.8	<a href="#">7640 04 19</a>	6	8.5	23.5	26	14	6.5	19.5	0.011
	G1/8	<a href="#">7640 04 10</a>	7	8.5	27	29.5	14	8	19.5	0.015
6	M5x0.8	<a href="#">7640 06 19</a>	6	10.5	23.5	26	16	6.5	21	0.001
	G1/8	<a href="#">7640 06 10</a>	7	10.5	27	29.5	16	8	20.5	0.015

## 7645

### Miniature Swivel Outlet Flow Regulator Exhaust, Male BSPT Thread



Technical polymer, nickel-plated brass, NBR

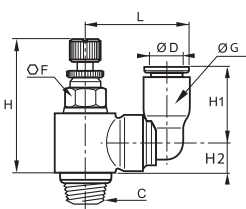

ØD	C		F	G	G1	H <sub>min</sub>	H <sub>max</sub>	H1	H2	J	L	Kg
4	R1/8	<a href="#">7645 04 10</a>	7	11.5	8.5	25	27.5	14	6	11.5	19.5	0.014
6	R1/8	<a href="#">7645 06 10</a>	7	11.5	10.5	25	27.5	16	6	11.5	21.5	0.012

Pre-coated thread

## 7649

### Miniature Swivel Outlet Flow Regulator Supply, Male BSPP and Metric Thread



Technical polymer, nickel-plated brass, NBR

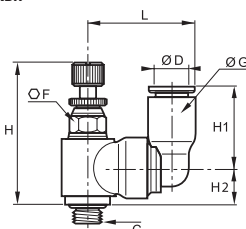

ØD	C		F	G	H <sub>min</sub>	H <sub>max</sub>	H1	H2	L	Kg
4	M5x0.8	<a href="#">7649 04 19</a>	6	8.5	23.5	26	14	6.5	19	0.015
	G1/8	<a href="#">7649 04 10</a>	7	8.5	27	29.5	14	8.5	19.5	0.014
6	M5x0.8	<a href="#">7649 06 19</a>	6	10.5	23.5	26	16	6.5	21	0.008
	G1/8	<a href="#">7649 06 10</a>	7	10.5	27	29.5	16	8.5	21.5	0.015

## Associated Products

All our flow control regulators are compatible with the range of polyamide and polyurethane tubing shown in Chapter 3.



# In-Line Regulators with External Adjustment

## 7770 In-Line One-Way Flow Regulator



Technical polymer, nickel-plated brass, NBR

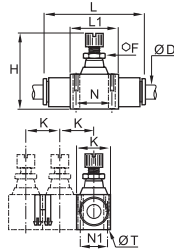

ØD		F	H <sub>min</sub>	H <sub>max</sub>	K	L	L1	N	N1	ØT	Kg
4	<a href="#">7770 04 00</a>	5	29.5	33.5	12	36	15	11	8	2.2	0.010
6	<a href="#">7770 06 00</a>	8	40.5	44.5	17	51	23	17	11	3.2	0.027
8	<a href="#">7770 08 00</a>	11	46.5	52.5	18.5	58	26	20	12.5	3.2	0.048
10	<a href="#">7770 10 00</a>	14	53	61	24	73	33	26	16	4.2	0.097
12	<a href="#">7770 12 00</a>	14	59	67.5	28	85	35	27.5	20	4.2	0.132

## 7772 Bi-Directional In-Line Flow Regulator



Technical polymer, nickel-plated brass, NBR

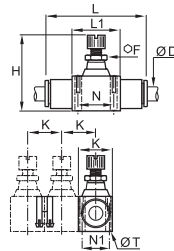

ØD		F	H <sub>min</sub>	H <sub>max</sub>	K	L	L1	N	N1	ØT	Kg
4	<a href="#">7772 04 00</a>	5	29.5	33.5	12	36	15	11	8	2.2	0.011
6	<a href="#">7772 06 00</a>	8	40	44.5	17	51	23	17	11	3.2	0.032
8	<a href="#">7772 08 00</a>	11	46.5	52.5	18.5	58	26	20	12.5	3.2	0.054

## 7776 Panel-Mountable In-Line One-Way Flow Regulator



Technical polymer, nickel-plated brass, NBR

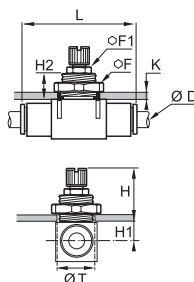

ØD		F	F1	H	H <sub>max</sub>	H1	H2	K	L	ØT	Kg
4	<a href="#">7776 04 00*</a>	14	-	21.5	25.5	6.5	11	6	36	10.5	0.017
6	<a href="#">7776 06 00*</a>	19	-	27.5	32.5	7.5	13.5	7	51	16.5	0.042
8	<a href="#">7776 08 00</a>	24	11	28.5	34.5	9	13.5	7	58	18.5	0.069
10	<a href="#">7776 10 00</a>	30	14	29.5	38.5	11.5	13.5	7	73	24.5	0.136
12	<a href="#">7776 12 00</a>	32	14	32	42	12.5	15.5	8	85	27.5	0.185

\*Ultrafine adjustment

## 7771 In-Line One-Way Flow Regulator, Female BSPP Thread



Technical polymer, nickel-plated brass, NBR

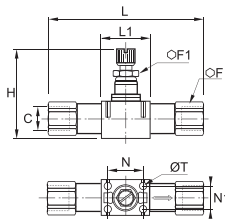

C		F	F1	H <sub>min</sub>	H <sub>max</sub>	L	L1	N	N1	ØT	Kg
G1/8	<a href="#">7771 10 10</a>	13	8	39.5	44.5	68.5	23	17	11	3.2	0.043
G1/4	<a href="#">7771 13 13</a>	16	11	44	50	83	26	20	12.5	3.2	0.103
G3/8	<a href="#">7771 17 17</a>	19	14	52	61	97	33	26	16	4.2	0.160
G1/2	<a href="#">7771 21 21</a>	24	14	57.5	67.5	121	35	27.5	20	4.2	0.260

## 7000 Joining Clips

Technical polymer



ØD		Kg
4	<a href="#">7000 00 05</a>	0.005
6	<a href="#">7000 00 05</a>	0.005
8	<a href="#">7000 00 05</a>	0.005
10	<a href="#">7000 00 06</a>	0.009
12	<a href="#">7000 00 06</a>	0.009

# In-Line Regulators with External Adjustment

**7020**

Straight Flow Regulator Exhaust, Male BSPP Thread



Technical polymer, nickel-plated brass, NBR

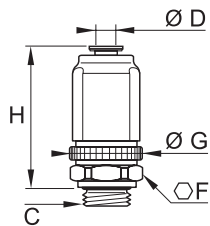

ØD	C		F	G	H min	H max	Kg
4	G1/8	<a href="#">7020 04 10</a>	18	21.5	38.5	44	0.062
6	G1/8	<a href="#">7020 06 10</a>	18	21.5	38.5	44	0.058
	G1/4	<a href="#">7020 06 13</a>	18	21.5	38.5	44	0.060
8	G1/8	<a href="#">7020 08 10</a>	24	27	46.5	52.5	0.110
	G1/4	<a href="#">7020 08 13</a>	24	27	46.5	52.5	0.112

# Plug-In Regulators with External Adjustment

## 7030 Compact Plug-In Flow Regulator, Exhaust



Technical polymer, nickel-plated brass, NBR

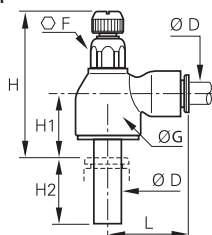

ØD		F	G	H <sub>min</sub>	H <sub>max</sub>	H1	H2	L	Kg
6	<a href="#">7030 06 00</a>	10	16	35	41	14	17	22	0.013
8	<a href="#">7030 08 00</a>	14	19	39.5	46.5	16	21.5	28	0.022
10	<a href="#">7030 10 00</a>	17	23	43.5	51.5	17.5	24.5	31.5	0.030
12	<a href="#">7030 12 00</a>	17	23	43	51	17	27	35	0.044

## 7031 Compact Plug-In Flow Regulator, Supply



Technical polymer, nickel-plated brass, NBR

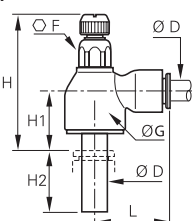

ØD		F	G	H <sub>min</sub>	H <sub>max</sub>	H1	H2	L	Kg
6	<a href="#">7031 06 00</a>	10	16	35	41	14	17	22	0.013
8	<a href="#">7031 08 00</a>	14	19	39.5	46.5	16	21.5	28	0.035
10	<a href="#">7031 10 00</a>	17	23	43.5	51.5	17.5	24.5	31.5	0.010
12	<a href="#">7031 12 00</a>	17	23	43	51	17	27	35	0.044

## 7630 Miniature Plug-In Flow Regulator, Exhaust



Technical polymer, nickel-plated brass, NBR

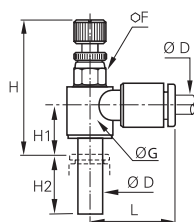

ØD		F	G	H <sub>min</sub>	H <sub>max</sub>	H1	H2	L	Kg
4	<a href="#">7630 04 00</a>	6	9	25.5	28	9.5	15.5	17	0.007
6	<a href="#">7630 06 00</a>	7	11.5	27.5	29	10.5	17	18.5	0.012

## 7631 Miniature Plug-In Flow Regulator, Supply



Technical polymer, nickel-plated brass, NBR

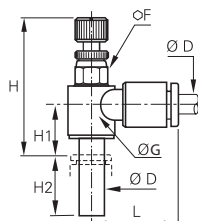

ØD		F	G	H <sub>min</sub>	H <sub>max</sub>	H1	H2	L	Kg
4	<a href="#">7631 04 00</a>	6	9	25.5	28	9.5	15.5	17	0.007
6	<a href="#">7631 06 00</a>	7	11.5	27.5	29	10.5	17	18.5	0.011

# Metal Regulators with Recessed Adjustment

## 7130

### Flow Regulator, Exhaust, Male BSPP and Metric Thread



Nickel-plated brass, NBR

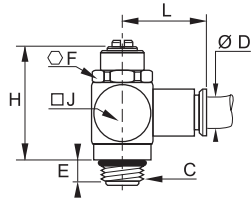

ØD	C		E	F	H	J	L	Kg
4	M5x0.8	<a href="#">7130 04 19</a>	4	8	17	9	19	0.010
	G1/8	<a href="#">7130 04 10</a>	5	13	34	15	20	0.036
6	M5x0.8	<a href="#">7130 06 19</a>	4	8	17	9	24	0.013
	G1/8	<a href="#">7130 06 10</a>	5	13	34	15	22	0.038
	G1/4	<a href="#">7130 06 13</a>	8	17	39	18	24	0.062
8	G1/8	<a href="#">7130 08 10</a>	5	13	34	15	25	0.042
	G1/4	<a href="#">7130 08 13</a>	8	17	39	18	28	0.066
	G3/8	<a href="#">7130 08 17</a>	7	20	47	21.5	29	0.109
10	G1/4	<a href="#">7130 10 13</a>	8	17	39	18	30	0.075
	G3/8	<a href="#">7130 10 17</a>	7	20	47	21.5	32	0.120
	G1/2	<a href="#">7130 10 21</a>	8	23	61	28	34	0.227
12	G3/8	<a href="#">7130 12 17</a>	7	20	47	22	36	0.064
	G1/2	<a href="#">7130 12 21</a>	8	23	61	28	38	0.306

## 7140

### Flow Regulator Exhaust, Male/Female BSPP and Metric Thread



Nickel-plated brass, NBR

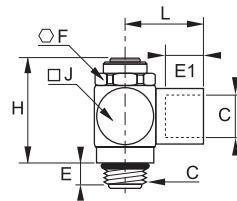

C		E	E1	F	H	J	L	Kg
M5x0.8	<a href="#">7140 19 19</a>	4	4	8	21	9	11	0.009
G1/8	<a href="#">7140 10 10</a>	5	8	13	32	15	17	0.039
G1/4	<a href="#">7140 13 13</a>	8	12	17	39	18	24	0.073
G3/8	<a href="#">7140 17 17</a>	7	12	20	47	21.5	27	0.125
G1/2	<a href="#">7140 21 21</a>	8	15	23	61	28	31	0.238

## 7160

### Flow Regulator with Brass Compression Fitting, Exhaust, Male BSPP Thread



Nickel-plated brass, NBR

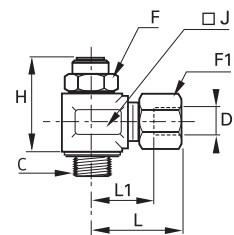

ØD	C		F	F1	H	J	L	L1	Kg
4	G1/8	<a href="#">7160 04 10</a>	13	10	26	17	25.5	14.5	0.049
	G1/8	<a href="#">7160 06 10</a>	13	13	26	17	25.5	14.5	0.054
6	G1/4	<a href="#">7160 06 13</a>	17	13	31.5	22	28.5	17.5	0.101
	G1/8	<a href="#">7160 08 10</a>	13	14	26	17	29.5	15.5	0.055
8	G1/4	<a href="#">7160 08 13</a>	17	14	31.5	22	31	17	0.101
	G1/4	<a href="#">7160 10 13</a>	17	19	31.5	22	35	19	0.118
10	G3/8	<a href="#">7160 10 17</a>	20	19	44.5	22	37.5	19	0.189
	G1/2	<a href="#">7160 10 21</a>	23	19	50	27	37.5	19	0.204
12	G3/8	<a href="#">7160 12 17</a>	20	22	44.5	22	38	21.5	0.200
	G1/2	<a href="#">7160 12 21</a>	23	22	50	27	38	21.5	0.213

# Metal Regulators with External Adjustment

## 7100 Compact Flow Regulator, Exhaust, Male BSPP Thread



Nickel-plated brass, NBR

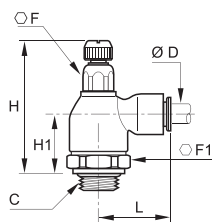

ØD	C		F	F1	H min	H max	H1	L	Kg
4	G1/8	<a href="#">7100 04 10</a>	10	19	47	53	23	21	0.080
	G1/8	<a href="#">7100 06 10</a>	10	19	47	53	23	24.5	0.082
6	G1/4	<a href="#">7100 06 13</a>	10	19	47.5	53	23.5	24.5	0.085
	G1/8	<a href="#">7100 08 10</a>	14	19	50	55	24.5	29	0.097
8	G1/4	<a href="#">7100 08 13</a>	14	19	50	56	25	29	0.100
	G3/8	<a href="#">7100 08 17</a>	17	25	56	62	27	30.5	0.154
10	G1/4	<a href="#">7100 10 13</a>	14	19	50	56	25	35	0.106
	G3/8	<a href="#">7100 10 17</a>	17	25	56	62	27	35	0.157
12	G3/8	<a href="#">7100 12 17</a>	17	25	56	62	27	38	0.198
	G1/2	<a href="#">7100 12 21</a>	17	25	55	62	27	38	0.207
14	G1/2	<a href="#">7100 14 21</a>	17	25	55	62	27	41	0.205

## 7101 Compact Flow Regulator, Supply, Male BSPP Thread



Nickel-plated brass, NBR

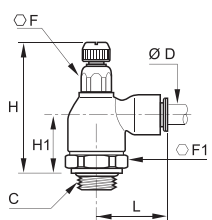

ØD	C		F	F1	H min	H max	H1	L	Kg
4	G1/8	<a href="#">7101 04 10</a>	10	19	47	53	23	21	0.096
	G1/8	<a href="#">7101 06 10</a>	10	19	47	53	23	24.5	0.081
6	G1/4	<a href="#">7101 06 13</a>	10	19	47.5	53	23.5	24.5	0.084
	G1/8	<a href="#">7101 08 10</a>	14	19	50	55	24.5	29	0.097
8	G1/4	<a href="#">7101 08 13</a>	14	19	50	56	25	29	0.100
	G3/8	<a href="#">7101 08 17</a>	17	25	56	62	27	30.5	0.155

## 7680 Compact Flow Regulator, Male BSPP Thread



Nickel-plated brass, NBR

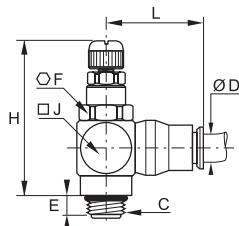

ØD	C		E	F	H min	H max	J	L	Kg
6	G1/8	<a href="#">7680 06 10</a>	5	13	39	44	7.5	24.5	0.045
	G1/8	<a href="#">7680 08 10</a>	5	13	39	44	7.5	24.5	0.047
8	G1/4	<a href="#">7680 08 13</a>	8	17	41	47	9	27	0.076
	G3/8	<a href="#">7680 10 17</a>	7	20	50	60	11	34	0.133
12	G1/2	<a href="#">7680 12 21</a>	8	23	65	77	14	36.5	0.165

## 7180 Miniature Flow Regulator Exhaust, Male BSPP and Metric Thread



Nickel-plated brass, NBR

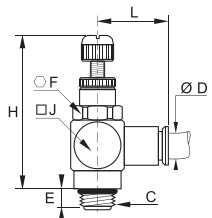

ØD	C		E	F	H min	H max	J	L	Kg
4	M5x0.8	<a href="#">7180 04 19</a>	4	8	24	29	10	19	0.012
	G1/8	<a href="#">7180 04 10</a>	5	13	39	44	15	20	0.041
6	M5x0.8	<a href="#">7180 06 19</a>	4	8	24	29	10	24	0.015
	G1/8	<a href="#">7180 06 10</a>	5	13	39	44	15	22	0.043
8	G1/8	<a href="#">7180 08 10</a>	5	13	39	44	15	26	0.049

## 7110 Compact Flow Regulator Exhaust, Male/Female BSPP Thread



Nickel-plated brass, NBR

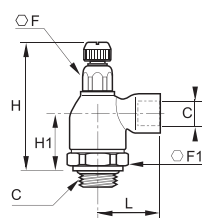

C		F	F1	H min	H max	H1	L	Kg
G1/8	<a href="#">7110 10 10</a>	10	19	47	52.5	23	22.5	0.080
G1/4	<a href="#">7110 13 13</a>	14	19	50.5	55.5	25	32	0.107
G3/8	<a href="#">7110 17 17</a>	17	25	56	62	27	34.5	0.212
G1/2	<a href="#">7110 21 21</a>	17	25	55	62	27	37.5	0.191

# Metal Regulators with External Adjustment

## 7111 Compact Flow Regulator Supply, Male/Female BSPP Thread



Nickel-plated brass, NBR

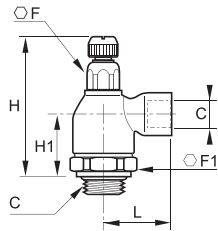

C		F	F1	H <sub>min</sub>	H <sub>max</sub>	H1	L	Kg
G1/8	<a href="#">7111 10 10</a>	10	19	47	52.5	23	22.5	0.079
G1/4	<a href="#">7111 13 13</a>	14	19	50.5	55.5	25	32	0.108

## 7190 Miniature Flow Regulator Exhaust, Male/Female BSPP and Metric Thread



Nickel-plated brass, NBR

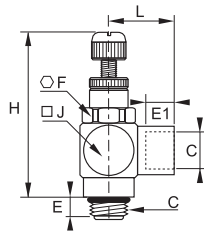

C		E	E1	F	H <sub>min</sub>	H <sub>max</sub>	J	L	Kg
M5x0.8	<a href="#">7190 19 19</a>	4	4	8	24	29	10	11	0.012
G1/8	<a href="#">7190 10 10</a>	5	8	13	39	44	15	17	0.044

## 7762 Flow Regulator Exhaust, with Brass Compression Fitting, Male BSPP Thread



Brass, NBR, zinc-plated steel with NBR seal, nickel-plated brass

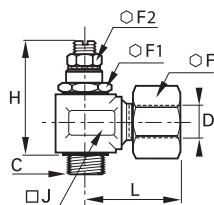

ØD	C		F	F1	F2	H <sub>min</sub>	H <sub>max</sub>	J	L	Kg
8	G1/8	<a href="#">7762 08 10*</a>	14	14	7	35.5	38.5	17	28.5	0.056
10	G1/4	<a href="#">7762 10 13</a>	19	17	10	44	49	22	36.5	0.125
14	G3/8	<a href="#">7762 14 17</a>	24	22	13	58	65	27	37.5	0.220
18	G1/2	<a href="#">7762 18 21</a>	30	27	19	62.5	68.5	34	44	0.403

\*with adjustment knurl

## 7170 Panel-Mountable In-Line Flow Regulator, Female BSPP and Metric Thread



Treated aluminium, NBR, brass

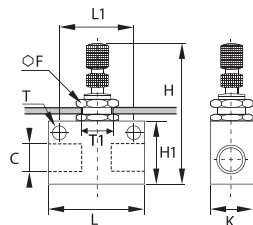

C		F	H <sub>min</sub>	H <sub>max</sub>	H1	K	L	L1	ØT	ØT1	Kg
M5x0.8	<a href="#">7170 19 19</a>	12	38	42	15	12	25	18	4.5	10.5	0.022
G1/8	<a href="#">7170 10 10</a>	15	49	56	22	18	35	24.7	4.5	12.5	0.056
G1/4	<a href="#">7170 13 13</a>	15	57	64	30	20	46	35	6.5	12.5	0.085
G3/8	<a href="#">7170 17 17</a>	22	62	73	30	25	50	35	6.5	18.5	0.153
G1/2	<a href="#">7170 21 21</a>	22	72	83	40	25	60	44	6.5	18.5	0.196

# Stainless Steel Flow Control Regulators

Stainless steel flow control regulators are used to **regulate the speed of a cylinder rod** as well as gas flow in environments with high mechanical or chemical constraints.

## Product Advantages

- Robust**
  - Suitable for corrosive environments
  - Excellent mechanical and chemical resistance
  - 100% leak-tested in production
  - No contamination of conveyed fluids
- Optimised Design**
  - Smooth external surfaces to facilitate cleaning
  - Fully compatible with food environments
  - Accurate and easy adjustment



Food Process  
Robotics  
Textile  
Semi-Conductors  
Packaging  
Pneumatics  
Automotive Process

Applications

## Technical Characteristics

<b>Compatible Fluids</b>	Compressed air <b>7822:</b> all compatible fluids depending on whether FKM or PTFE seals are used
<b>Working Pressure</b>	<b>7810-7812:</b> 1 to 10 bar <b>7820:</b> 1 to 16 bar <b>7822:</b> 1 to 40 bar
<b>Working Temperature</b>	<b>7810 – 7812:</b> 0°C to +70°C <b>7820 – 7822:</b> -15° to +120°C

### Component Materials



External Components

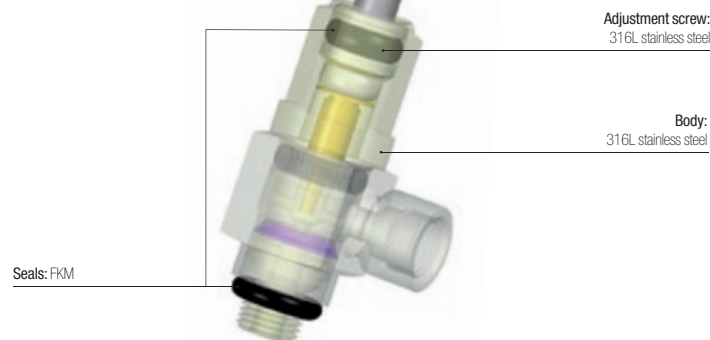

### Regulations

DI: 2002/95/EC (RoHS)  
RG: 1907/2006 (REACH)  
DI: 97/23/EC (PED)  
RG: External Components: 21CFR (FDA)  
RG: External Components: 1935/2004/EC

## Operation

### Exhaust Model with External Adjustment

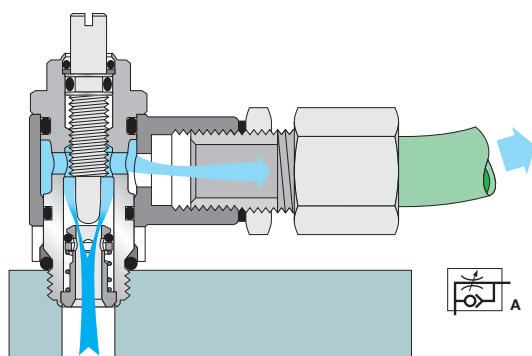

### Bi-Directional Model with External Adjustment

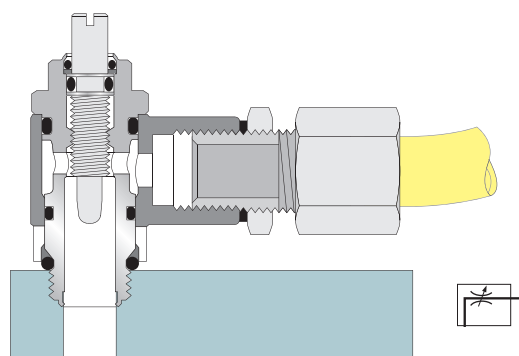

# Stainless Steel Flow Control Regulators

## 7810 Flow Regulator Exhaust, Male/Female BSPP and Metric Thread



Stainless steel 316L, FKM

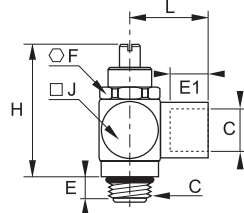

C		E	E1	F	H <sub>min</sub>	H <sub>max</sub>	J	L	Kg
M5x0.8	<a href="#">7810 19 19</a>	4	4	8	22	26	9	11	0.011
G1/8	<a href="#">7810 10 10</a>	6	8	13	32	38	15	17	0.040
G1/4	<a href="#">7810 13 13</a>	9	12	17	35	40	18	24	0.072
G3/8	<a href="#">7810 17 17</a>	8	12	20	43	53	22	27	0.126
G1/2	<a href="#">7810 21 21</a>	9	15	23	60	71	28	31	0.261

## 7812 Bi-Directional Flow Regulator, Male/Female BSPP and Metric Thread



Stainless steel 316L, FKM

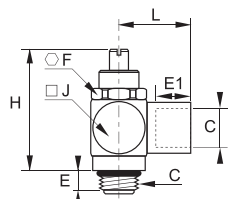

C		E	E1	F	H <sub>min</sub>	H <sub>max</sub>	J	L	Kg
M5x0.8	<a href="#">7812 19 19</a>	4	4	8	22	26	9	11	0.011
G1/8	<a href="#">7812 10 10</a>	6	8	13	32	38	15	17	0.040
G1/4	<a href="#">7812 13 13</a>	9	12	17	35	40	18	24	0.074
G3/8	<a href="#">7812 17 17</a>	8	12	20	43	53	22	24	0.125
G1/2	<a href="#">7812 21 21</a>	9	15	23	60	71	28	31	0.261

## 7820 In-Line One-Way Flow Regulator, Female BSPP Thread



Stainless steel 316L, FKM

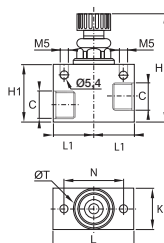

C	DN		H <sub>min</sub>	H <sub>max</sub>	H1	K	L	L1	N	ØT	Kg
G1/8	7	<a href="#">7820 00 10</a>	47	52.5	30	20	40	20	30	20	0.175
G1/4	7	<a href="#">7820 00 13</a>	47	52.5	30	20	40	20	30	20	0.164
G3/8	9	<a href="#">7820 00 17</a>	56	65	35	25	50	25	36	25	0.286
G1/2	12	<a href="#">7820 00 21</a>	76	87	40	30	60	30	42	30	0.262

## 7822 Bi-Directional In-Line Flow Regulator, Female BSPP Thread



Stainless steel 316L, FKM

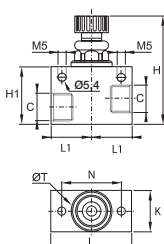

C	DN		H <sub>min</sub>	H <sub>max</sub>	H1	K	L	L1	N	ØT	Kg
G1/8	7	<a href="#">7822 00 10</a>	48	52.5	30	20	40	20	30	20	0.176
G1/4	7	<a href="#">7822 00 13</a>	48	52.5	30	20	40	20	30	20	0.165
G3/8	9	<a href="#">7822 00 17</a>	58	65	35	25	50	25	36	20	0.289
G1/2	12	<a href="#">7822 00 21</a>	76	87	40	30	60	30	42	30	0.265

You will also find our range of stainless steel push-in fittings, compression fittings, valves and accessories in this catalogue.



# Flow Characteristics (at 6 bar)

## for Flow Control Regulators



**7010**  
**7011**  
**7012**

### 7010

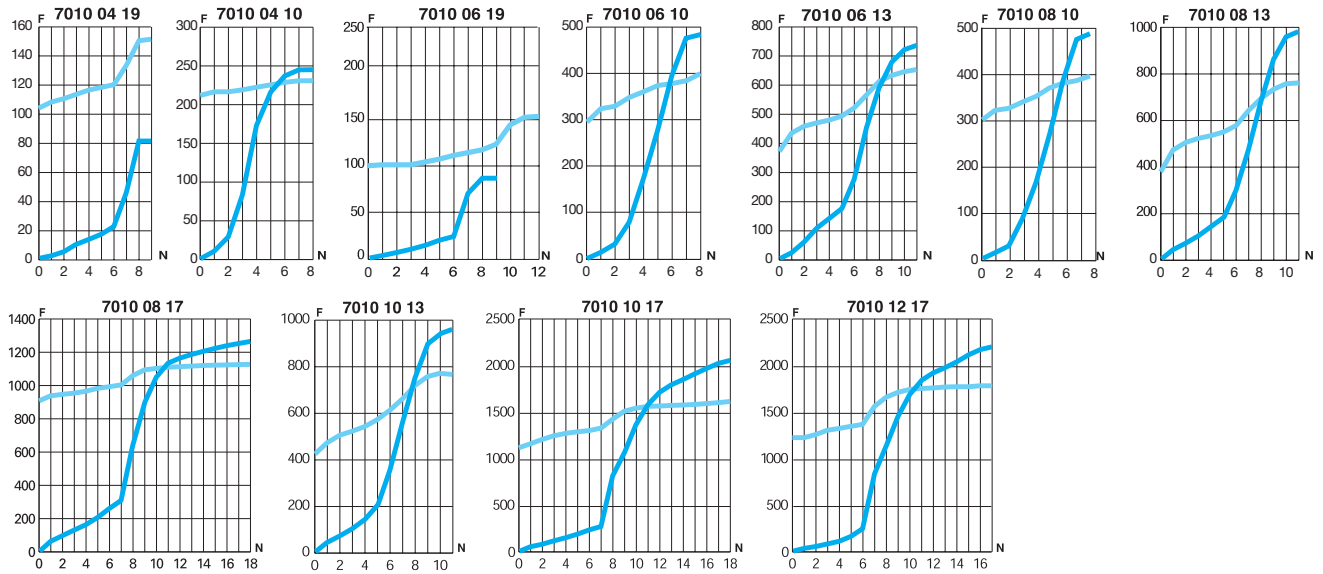

### 7011

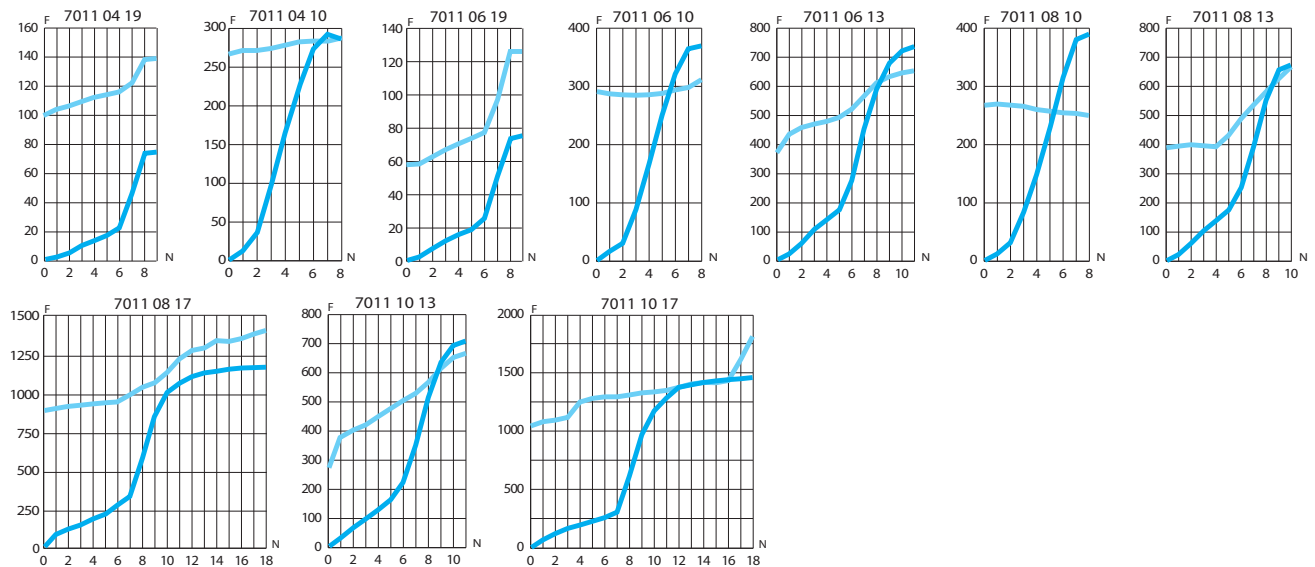

### 7012

#### Flow characteristics for model 7012:

- exhaust version (see model 7010, direction of adjustment)
- supply version (see model 7011, direction of adjustment)

6 bar

Direction of adjustment  
 Return

**F:** Flow in NI/min

**N:** Number of turns

# Flow Characteristics (at 6 bar)

## for Flow Control Regulators



**7060**  
**7061**  
**7062**

### 7060

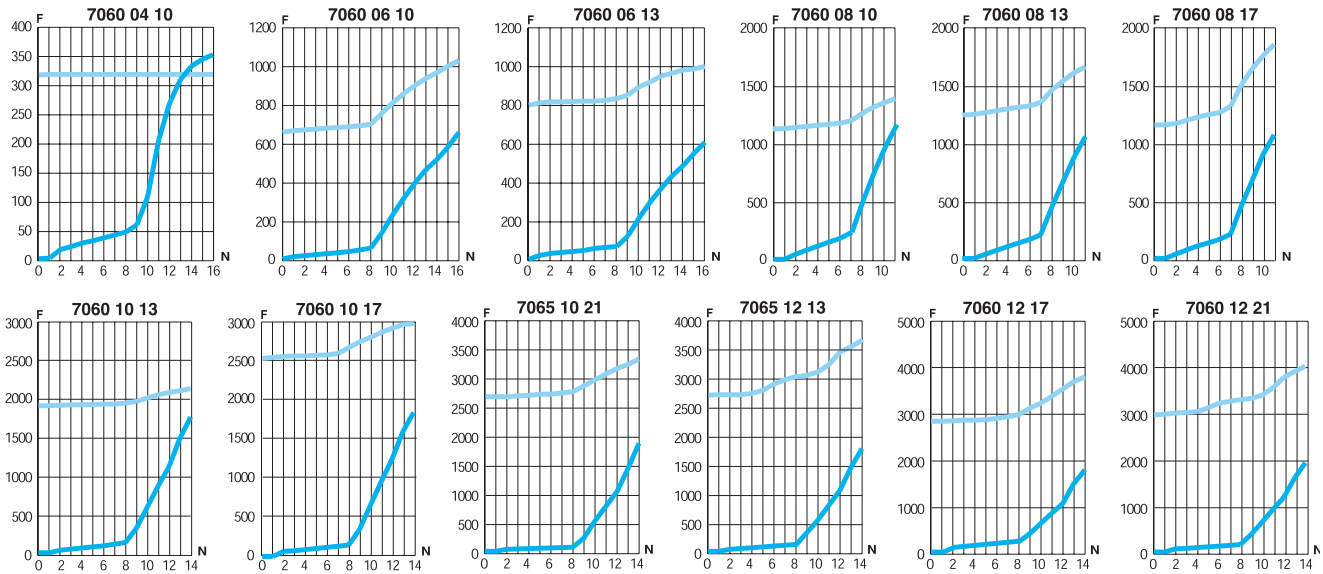

### 7061

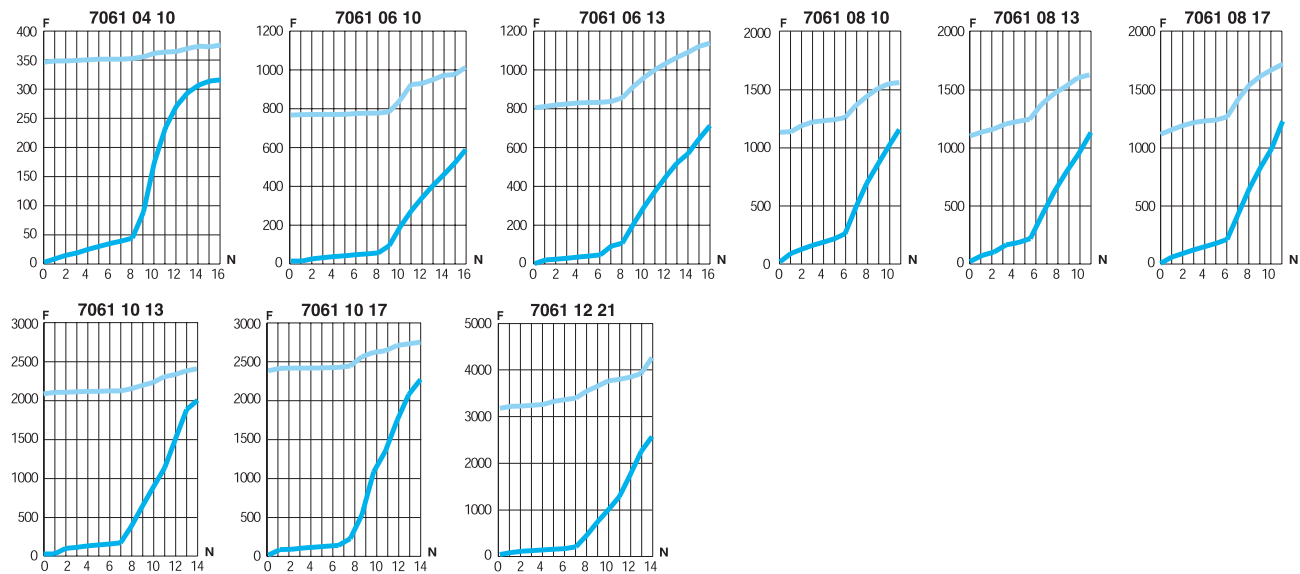

### 7062

#### Flow characteristics for model 7062:

- exhaust version (see model 7060, direction of adjustment)
- supply version (see model 7061, direction of adjustment)

# Flow Characteristics (at 6 bar)

## for Flow Control Regulators



**7660**  
**7669**  
**7662**

### 7660

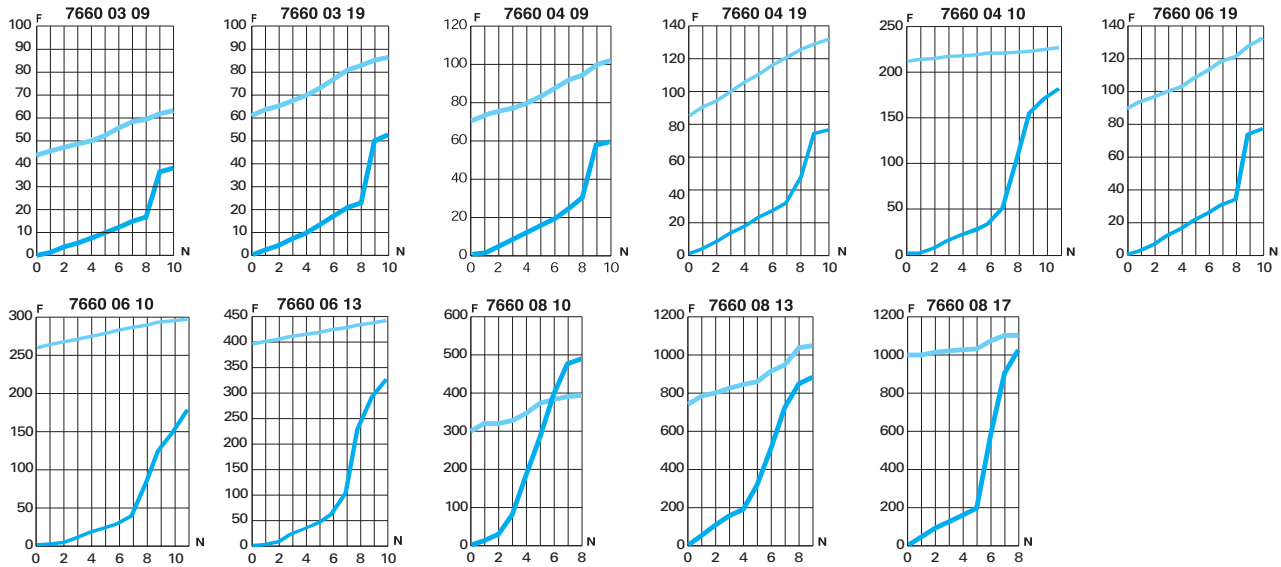

### 7669

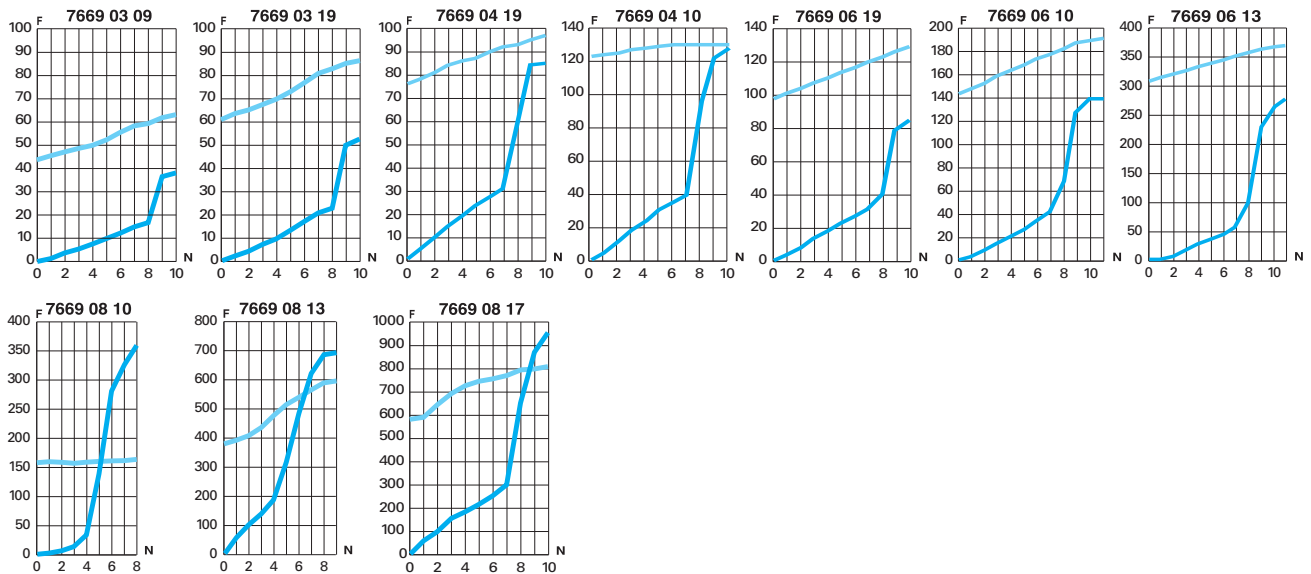

### 7662

#### Flow characteristics for model 7662:

- exhaust version: see model 7660, direction of adjustment
- supply version: see model 7669, direction of adjustment

6 bar

Direction of adjustment  
 Return

**F:** Flow in NI/min

**N:** Number of turns

# Flow Characteristics (at 6 bar)

## for Flow Control Regulators



**7640**  
**7649**

### 7640

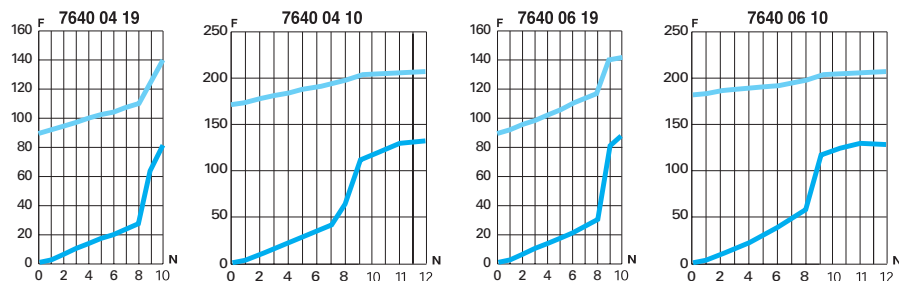

### 7649

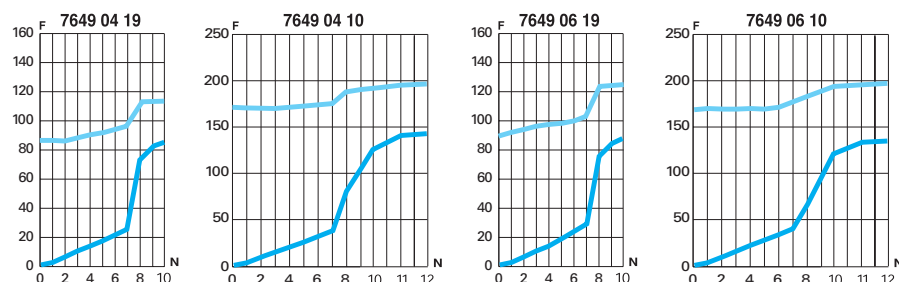

**7771**

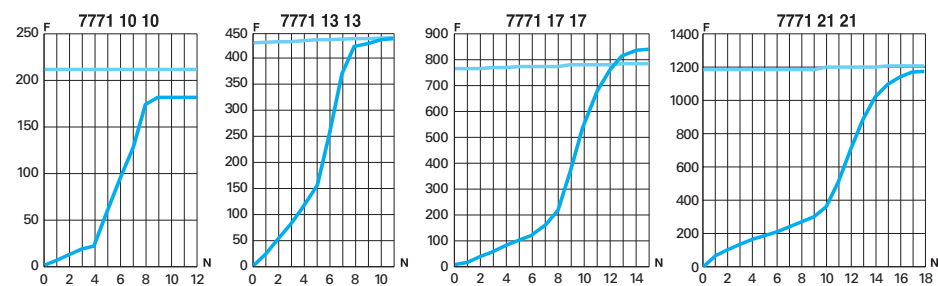

**7020**

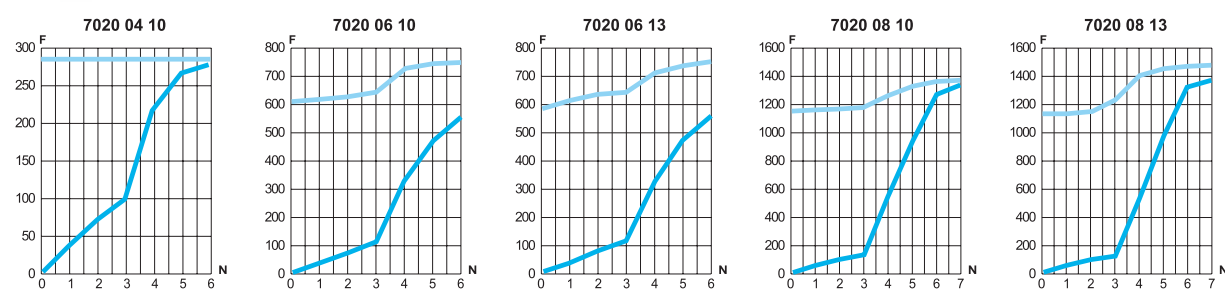

# Flow Characteristics (at 6 bar) for Flow Control Regulators



**7770**

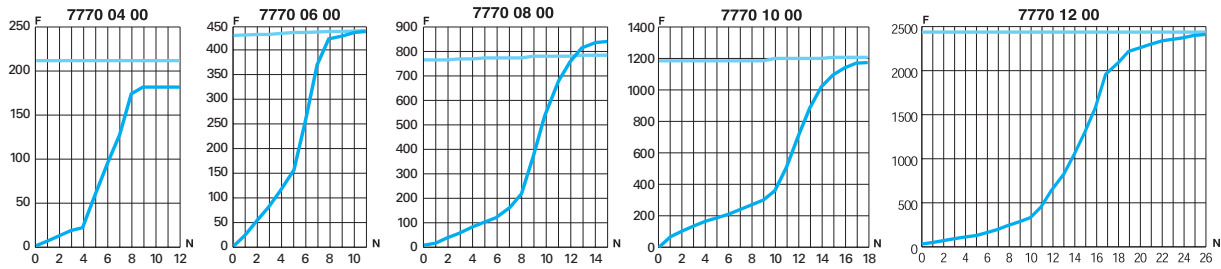

**7776**

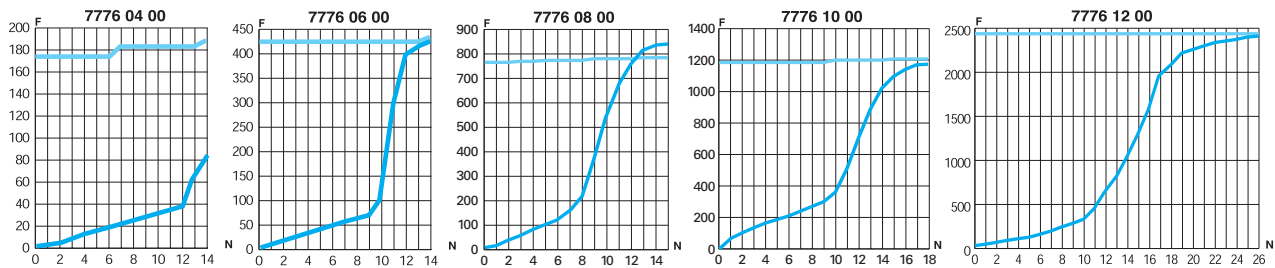

**7030**  
**7031**

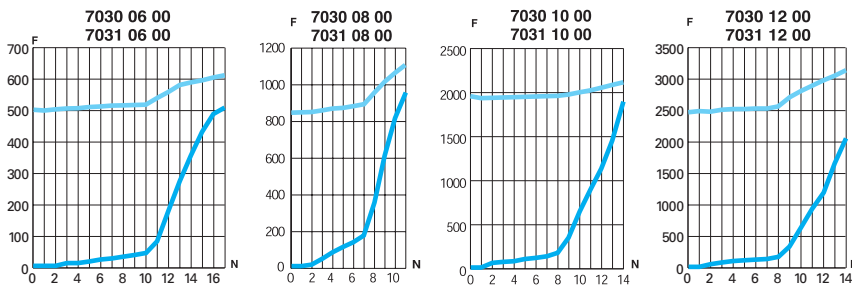

**7630**  
**7631**

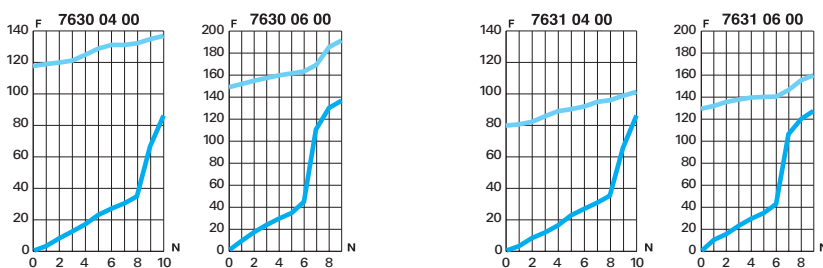

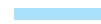
6 bar  
 Direction of adjustment  
 Return  
**F:** Flow in l/min  
**N:** Number of turns

# Flow Characteristics (at 6 bar)

## for Flow Control Regulators



**7065**  
**7066**  
**7067**

### 7065

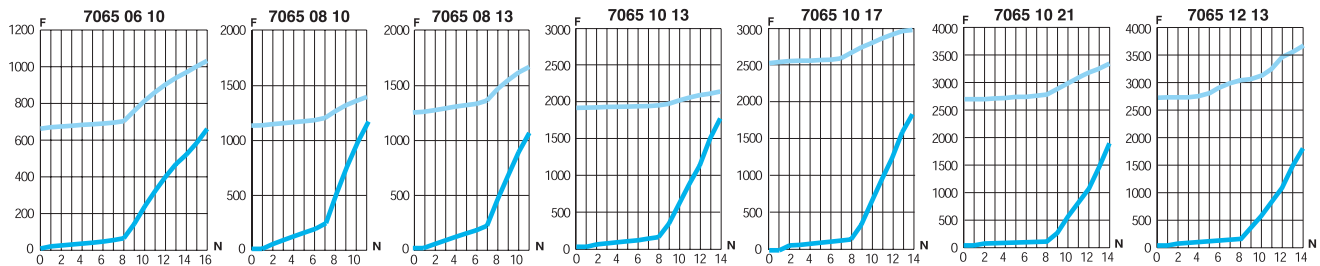

### 7066

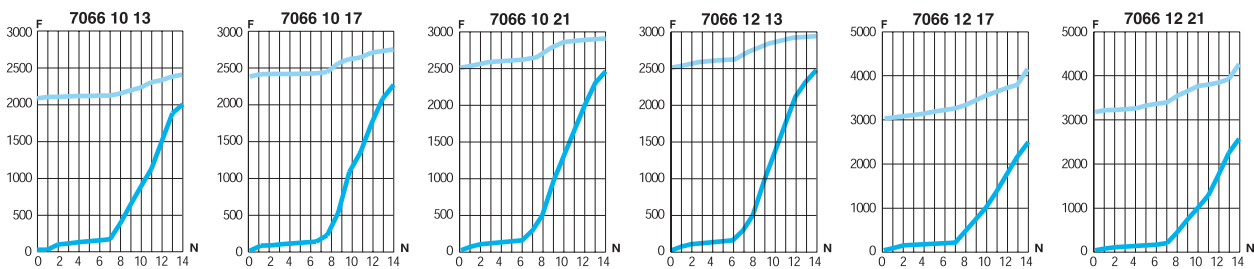

### 7067

**Flow characteristics for model 7067:**

- exhaust version: see model 7065, direction of adjustment
- supply version: see model 7066, direction of adjustment



**7665**  
**7668**

### 7665

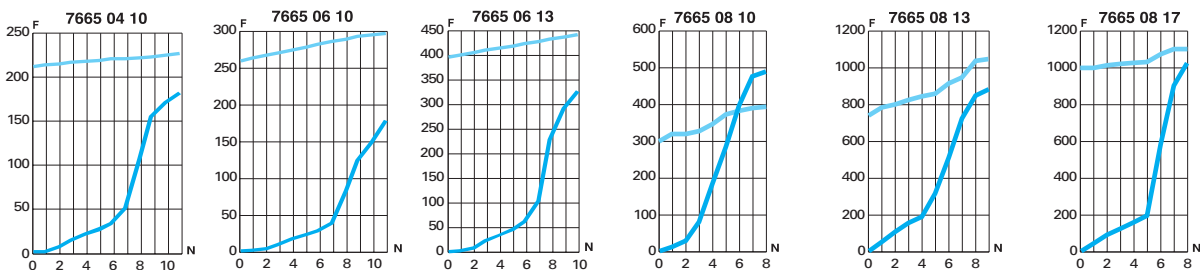

### 7668

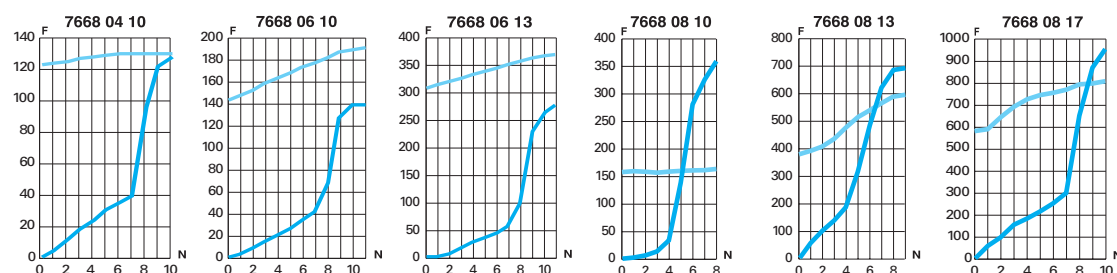

# Flow Characteristics (at 6 bar)

## for Flow Control Regulators



**7045**

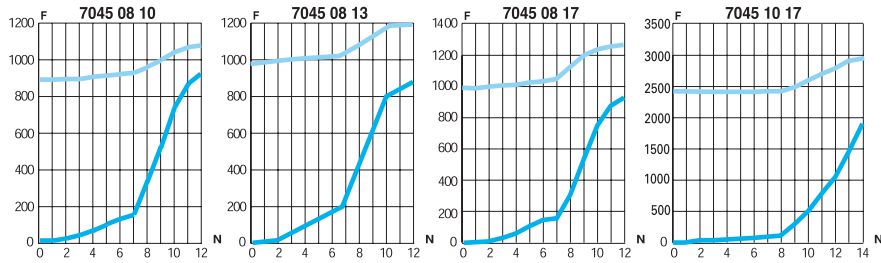

**7130**

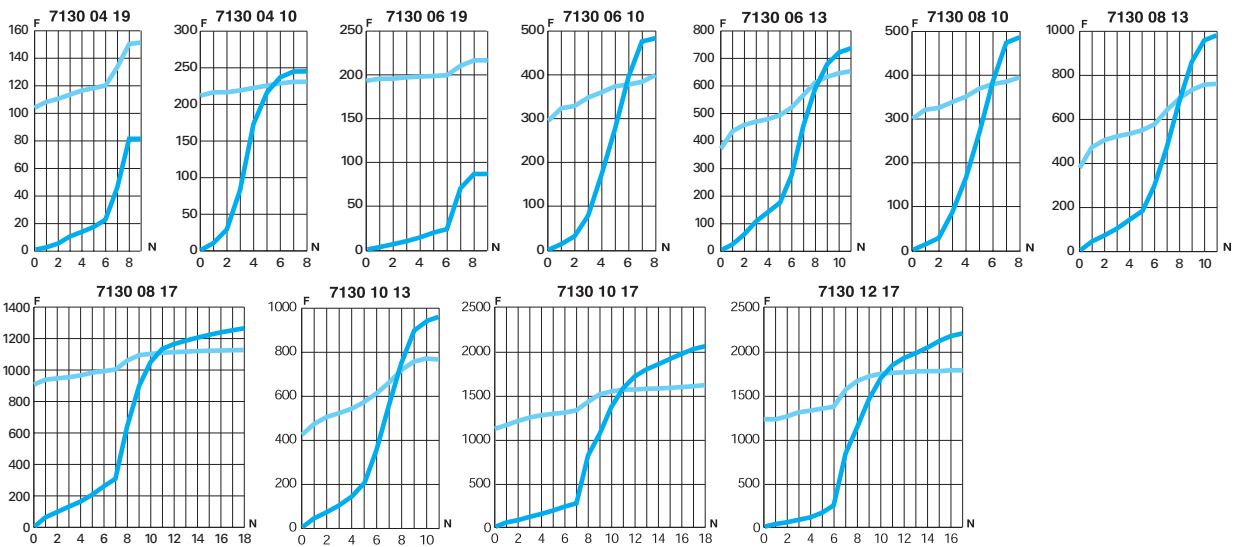

6 bar

Direction of adjustment  
 Return

**F:** Flow in NI/min  
**N:** Number of turns

# Flow Characteristics (at 6 bar)

## for Flow Control Regulators



**7140**

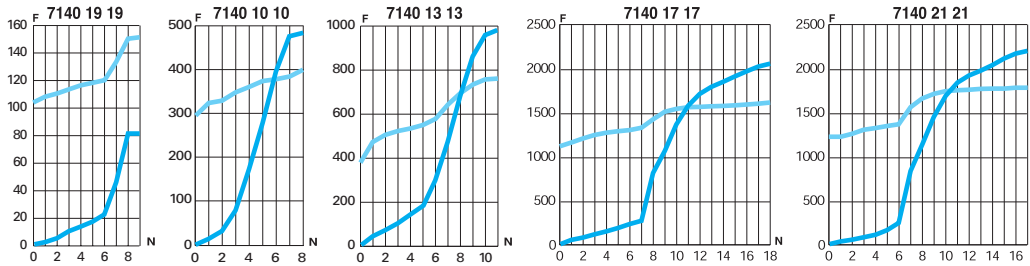

**7160**

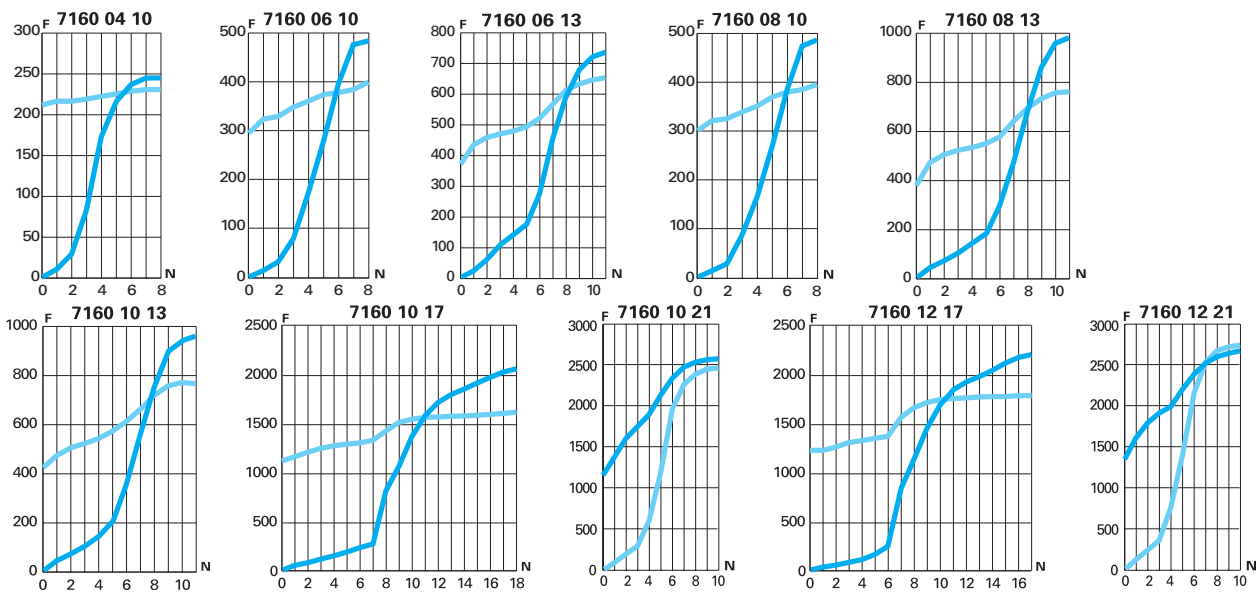

**7762**

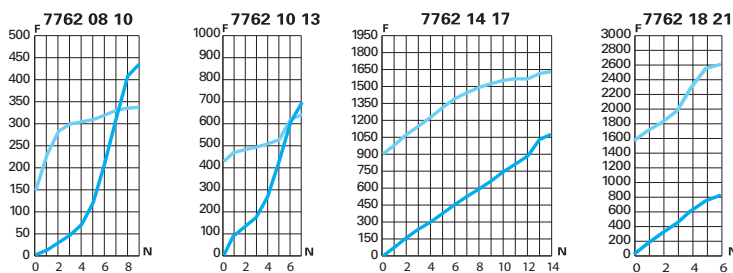



# Flow Characteristics (at 6 bar)

## for Flow Control Regulators



**7100**  
**7101**

### 7100

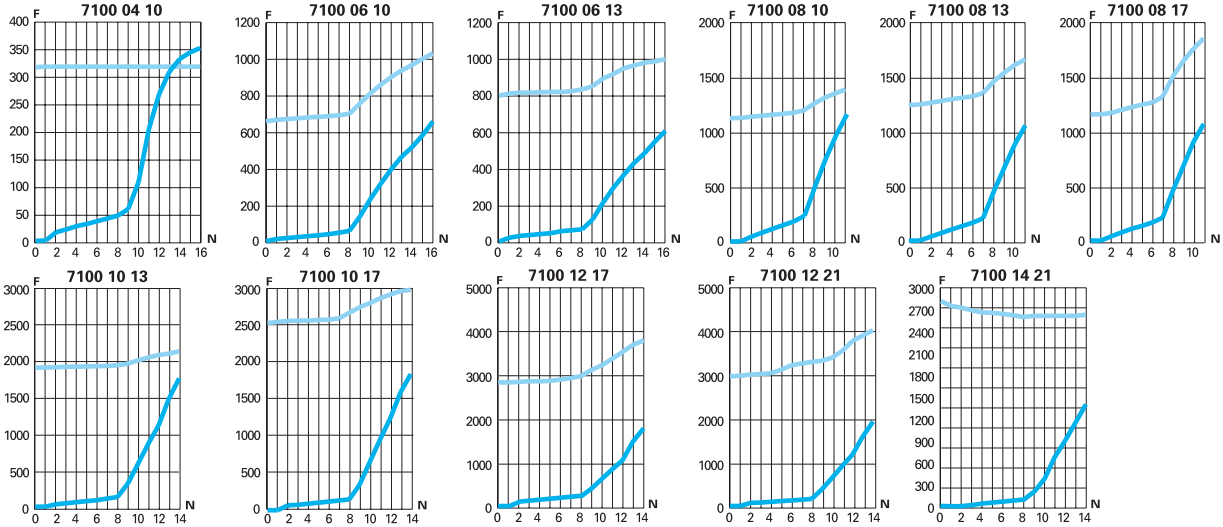

### 7101

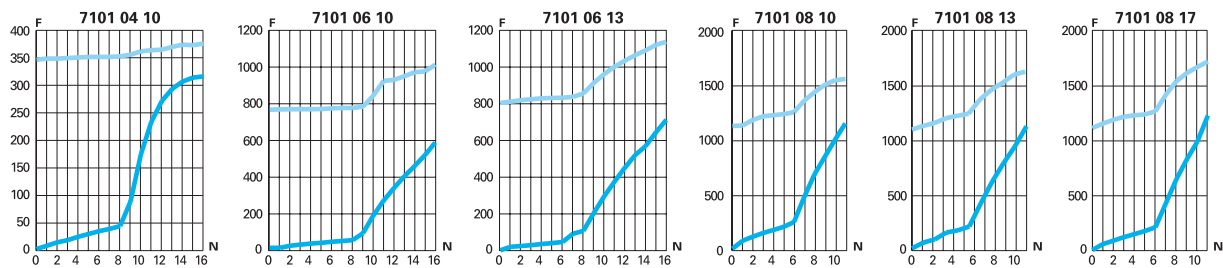

**7680**

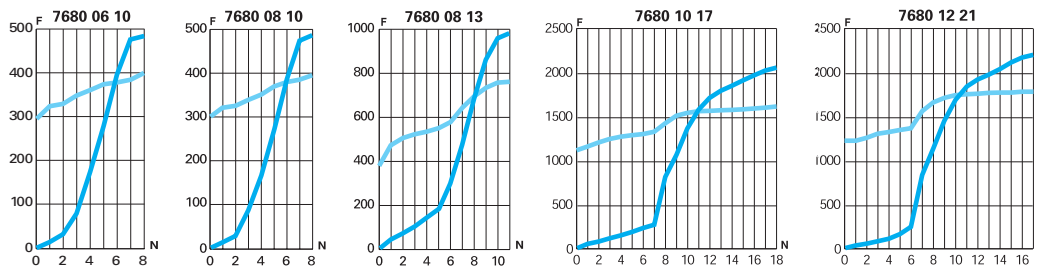

6 bar

Direction of adjustment  
 Return

**F:** Flow in NI/min  
**N:** Number of turns

# Flow Characteristics (at 6 bar)

## for Flow Control Regulators



### 7180

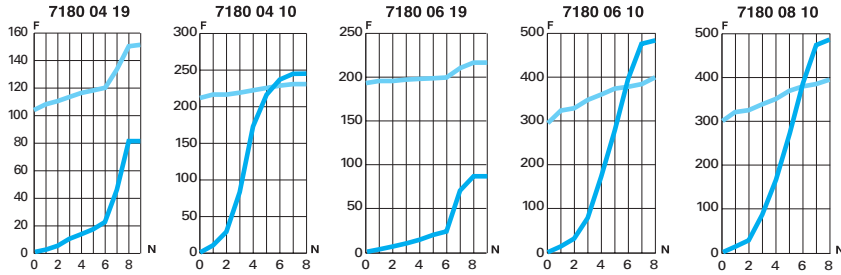

### 7110 7111

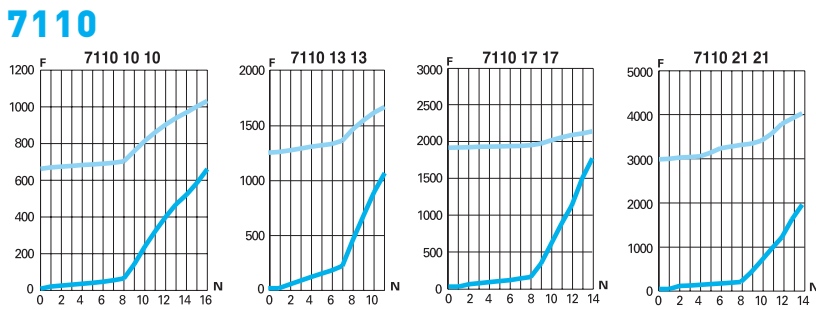

### 7111

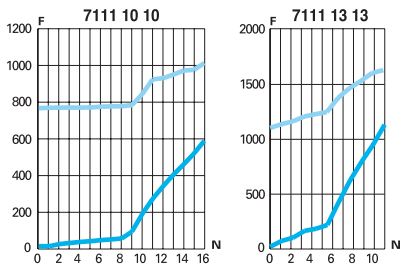

### 7170

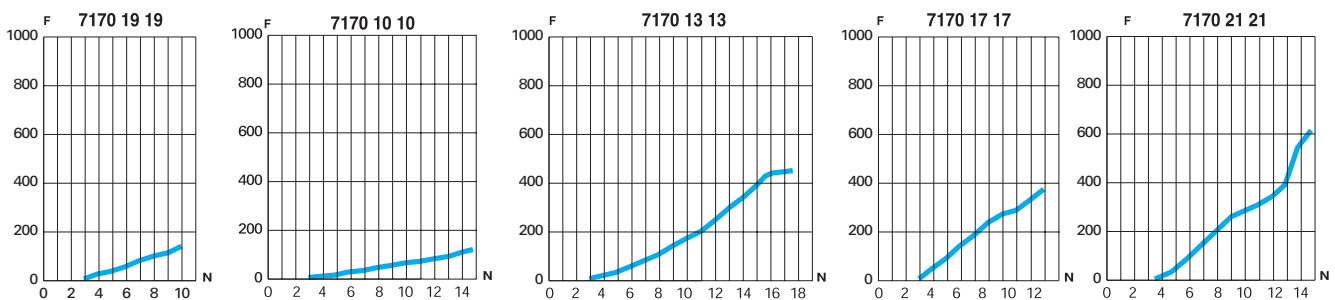

# Function Fittings Range

## Blocking Fittings

- 7880**  
BSPP  
Page 4-37
- 7881**  
BSPP  
Page 4-37
- 7885**  
BSPT  
Page 4-37
- 7886**  
BSPT  
Page 4-37
- 7883**  
BSPP  
Page 4-37



## Piloted Non-Return Valves

- 7892**  
BSPP  
Page 4-39
- 7894**  
BSPP  
Page 4-39



## Non-Return Valves

- 7996**  
Page 4-41
- 7984**  
**7994**  
BSPP/Metric  
Page 4-41
- 7985**  
**7995**  
BSPT  
Page 4-41



## Adjustable Non-Return Valves

- 7930**  
BSPP/Metric  
Page 4-43
- 7931**  
BSPP  
Page 4-43
- 7932**  
BSPP  
Page 4-43



## LIQUIfit® Non-Return Valves

- 7992**  
Page 4-45



## Stainless Steel Non-Return Valves

- 4890**  
BSPP  
Page 4-47
- 4891**  
BSPP  
Page 4-47
- 4892**  
BSPP  
Page 4-47
- 4895**  
NPT  
Page 4-47



## Soft Start Fittings

- 7860**  
BSPP  
Page 4-49
- 7870**  
BSPP  
Page 4-49
- 7861**  
BSPP  
Page 4-49
- 7871**  
BSPP  
Page 4-49



## Pneumatic Sensor Fittings

- 7818**  
BSPP/Metric  
Page 4-51
- 7828**  
BSPP/Metric  
Page 4-51



## Pressure Regulator Fittings

- 7300**  
BSPP  
Page 4-53



## Pressure Reducer Fittings

- 7318**  
BSPP  
Page 4-55
- 7471**  
BSPP  
Page 4-55
- 7316**  
Page 4-55
- 7416**  
BSPP  
Page 4-55
- 7000**  
Page 4-55
- 7000**  
Page 4-55



## Snap Fittings

- 7926**  
Page 4-57
- 7921**  
BSPP  
Page 4-57
- 7960**  
Page 4-57
- 7961**  
BSPP  
Page 4-57



## Manually-Operated Valves

- 7800**  
**7801**  
BSPP/Metric  
Page 4-59
- 7802**  
BSPP  
Page 4-59
- 0669**  
BSPP/Metric  
Page 4-59



# Function Fittings Range

## Metal Quick Exhaust Valves

- 7970**  
BSPP/Metric  
Page 4-61
- 7971**  
BSPP/BSPT  
Page 4-61
- 7899**  
BSPP  
Page 4-61



## Silencers

- 0674**  
BSPP/Metric  
Page 4-63
- 0676**  
BSPP/Metric  
Page 4-63
- 0670**  
BSPP  
Page 4-63
- 0673**  
BSPP/Metric  
Page 4-63
- 0675**  
BSPP/Metric  
Page 4-63
- 0671**  
Page 4-64
- 0677**  
BSPP  
Page 4-64
- 0672**  
BSPP  
Page 4-64
- 0682**  
BSPP  
Page 4-64
- 0683**  
NPT  
Page 4-64



# Blocking Fittings

Blocking fittings, mounted in pairs on a cylinder, lock the piston by simultaneously **cutting off the supply and exhaust** when the pilot signal is removed.

## Product Advantages

### Optimum Performance

- Optimum flow: no effect on the performance of the cylinder
- Compact size
- Fully orientable for excellent flexibility in circuit installation
- 100% leak-tested in production
- Date coding to guarantee quality and traceability

### Robust & Unsurpassed Life Time

- Suitable for the most demanding environments
- Excellent corrosion and spark resistance to salt spray and sparks (threaded models)
- Proven push-in technology
- Tried and tested durability according to DI 2006/42/CE



Robotics  
Machine Tools  
Textile  
Packaging  
Pneumatics  
Automotive Process

Applications

## Technical Characteristics

<b>Compatible Fluids</b>	Compressed air
<b>Working Pressure</b>	1 to 10 bar
<b>Working Temperature</b>	-20°C to +70°C -25°C to +70°C (metal version)

Connection	Supply Flow 6 bar	Pilot and depilot threshold depending on supply pressure					
		2 bar	4 bar	6 bar	8 bar	10 bar	
ØD 6 and 8 mm, threads G1/8, G1/4, R1/8, R1/4	650NI/min	Pilot Pressure	2.40	2.90	3.30	3.60	4.00
	650NI/min	Depilot Pressure	1.50	1.80	2.15	2.40	2.80
ØD 10 and 12 mm, threads G3/8, G1/2, R3/8, R1/2	1600NI/min	Pilot Pressure	2.70	3.20	3.50	3.80	4.10
	1600NI/min	Depilot Pressure	1.40	1.80	2.10	2.40	2.70

Reliable performance is dependent upon the type of fluid conveyed and component materials being used.

Use is guaranteed with a vacuum of 755 mm Hg (99% vacuum).

### Component Materials

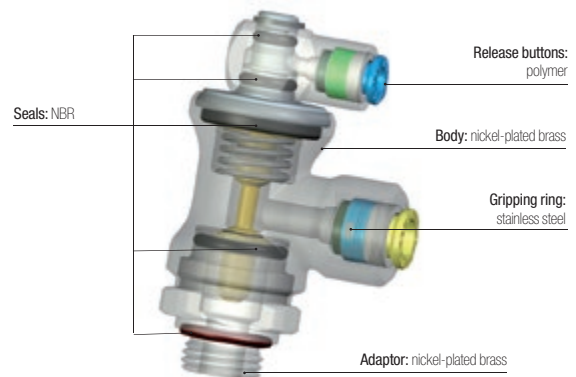

Silicone-free

### Regulations

DI: 2002/95/EC (RoHS)  
DI: 97/23/EC (PED)  
RG: 1907/2006 (REACH)

DI: 2006/42/EC (Machine Directive)  
test according to ISO 19973-5.  
B10d (1Hz) >70 millions of cycles

## Operation

### Cylinder in Operation (pilot signal active)

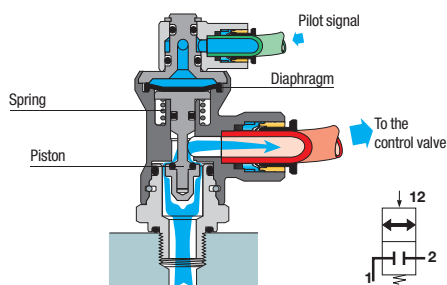

Pilot signal authorises movement

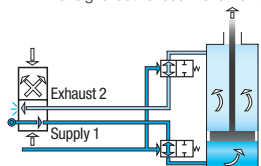

### Cylinder Blocked (pilot signal removed)

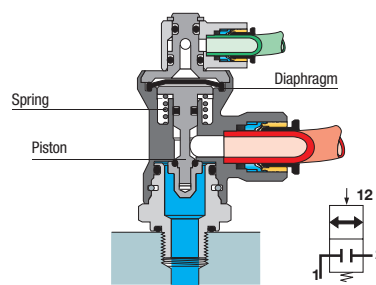

No signal blocks movement

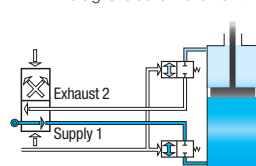

### Installation

Mounted in pairs, blocking fittings are installed directly on the cylinder. Being fully orientable, they offer excellent flexibility in the design and installation of pneumatic circuits.

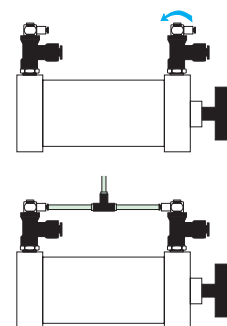

# Blocking Fittings

## 7880 Blocking Fitting, Male BSPP Thread

Nickel-plated brass, NBR

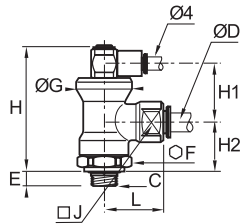

ØD	C		E	F	G	H	H1	H2	J	L	Kg
6	G1/8	<a href="#">7880 06 10</a>	5.5	21	24	53	24.5	21	17	28	0.127
	G1/4	<a href="#">7880 06 13</a>	6.5	21	24	53	24.5	21	17	28	0.130
8	G1/4	<a href="#">7880 08 13</a>	6.5	21	24	53	24.5	21	17	28	0.124
	G3/8	<a href="#">7880 08 17</a>	7.5	21	24	53	24.5	21	17	28	0.127
10	G3/8	<a href="#">7880 10 17</a>	7.5	24	28	58	25	25	27	35	0.210
12	G1/2	<a href="#">7880 12 21</a>	9	24	28	58	25	25	27	37.5	0.220

## 7885 Blocking Fitting, Male BSPT Thread

Nickel-plated brass, NBR

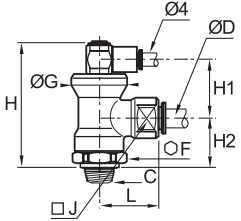

ØD	C		F	G	H	H1	H2	J	L	Kg
6	R1/8	<a href="#">7885 06 10</a>	21	24	51.5	25	20	17	28	0.127
	R1/4	<a href="#">7885 06 13</a>	21	24	51.5	25	20	17	28	0.131
8	R1/4	<a href="#">7885 08 13</a>	21	24	51.5	25	20	17	28	0.126
	R3/8	<a href="#">7885 08 17</a>	21	24	51.5	25	20	17	28	0.131
10	R3/8	<a href="#">7885 10 17</a>	24	28	57	25	24	27	35	0.217
12	R1/2	<a href="#">7885 12 21</a>	24	28	57	25	24	27	37.5	0.229

Pre-coated thread

## 7881 Blocking Fitting, Male/Female BSPP Thread

Nickel-plated brass, NBR

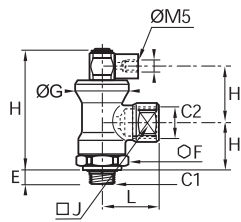

C1	C2		E	F	G	H	H1	H2	J	L	Kg
G1/8	G1/4	<a href="#">7881 13 10</a>	5.5	21	24	53	24.5	21	17	25.5	0.119
G1/4	G1/4	<a href="#">7881 13 13</a>	6.5	21	24	53	24.5	21	17	25.5	0.120
G3/8	G3/8	<a href="#">7881 17 17</a>	7.5	24	28	58	25	25	27	34	0.208
G1/2	G1/2	<a href="#">7881 21 21</a>	9	24	28	58	25	25	27	40	0.221

## 7886 Blocking Fitting, Male/Female BSPT Thread

Nickel-plated brass, NBR

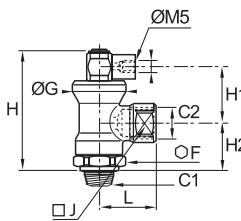

C1	C2		F	G	H	H1	H2	J	L	Kg
R1/8	R1/4	<a href="#">7886 13 10</a>	21	24	51.5	25	20	17	26.5	0.121
R1/4	R1/4	<a href="#">7886 13 13</a>	21	24	51.5	25	20	17	26.5	0.126
R3/8	R3/8	<a href="#">7886 17 17</a>	24	28	57	25	24	27	34	0.225
R1/2	R1/2	<a href="#">7886 21 21</a>	24	28	57	25	24	27	40	0.235

Pre-coated thread

## 7883 Blocker/Flow Regulator, Male BSPP Thread

Nickel-plated brass, technical polymer, NBR

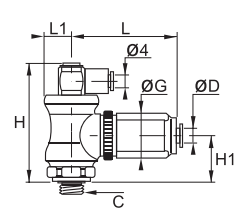

ØD	C		G	H	H1	L	L <sub>max</sub>	L1	Kg
4	G1/8	<a href="#">7883 04 10</a>	21.5	53	21	46.5	52	12	0.166
	G1/4	<a href="#">7883 06 10</a>	21.5	53	21	46.5	52	12	0.163
6	G1/4	<a href="#">7883 06 13</a>	21.5	53	21	46.5	52	12	0.166
	G1/4	<a href="#">7883 08 13</a>	27	57.5	24.5	54	60	14	0.252
8	G3/8	<a href="#">7883 08 17</a>	27	57.5	24.5	54	60	14	0.254

Combination of blocking and flow regulation functions

Working temperature: 0 to +70°C

# Piloted Non-Return Valves

Piloted non-return valves are designed to **protect installations**: if the compressed air supply is removed, they lock the air supply to the cylinder, thus maintaining it in position.

## Product Advantages

- System Protection**
  - Protection of your system
  - Control of inlet and outlet flow: cylinder operation optimised
  - Vent saves time on restart after maintenance operations (model 7894)
- 3 Functions in 1 Product**
  - A multi-purpose fitting:
    - piloted non-return valve
    - flow control regulator
    - manual exhaust
  - All-in-one product: integrated fittings for the control and supply
- Flexible Operation**
  - Orientable and adjustable through 3 axes
  - Can be integrated into any installation configuration
  - Push-in connection for quicker and more reliable installation
  - Mounted in pairs directly on the cylinder



**Applications**

Pneumatics  
 Assembly  
 Robotics  
 Machine Tools  
 Packaging  
 Handling  
 Automotive Process

## Technical Characteristics

<b>Compatible Fluids</b>	Compressed air
<b>Working Pressure</b>	1 to 10 bar
<b>Working Temperature</b>	-5°C to +60°C
<b>Cracking Pressure</b>	0.3 bar

### Regulations

DI: 2002/95/EC (RoHS)  
 RG: 1907/2006 (REACH)  
 DI: 97/23/EC (PED)

### Component Materials

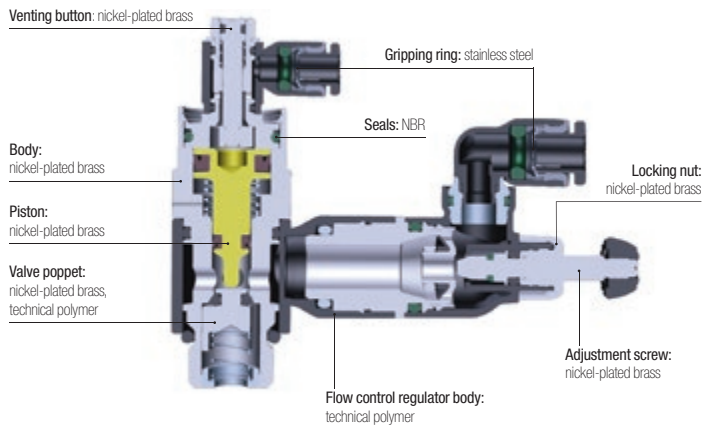

**Silicone-free**

## Operation

### Normal Operation

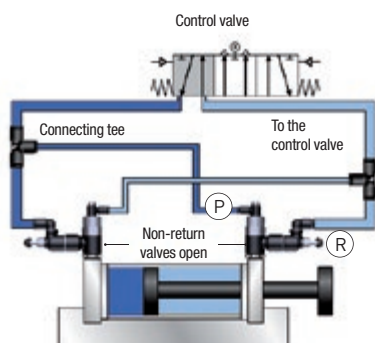

Pilot signal (P)  
 Regulation of cylinder rod speed (R)

### Emergency Stop or Pressure Drop

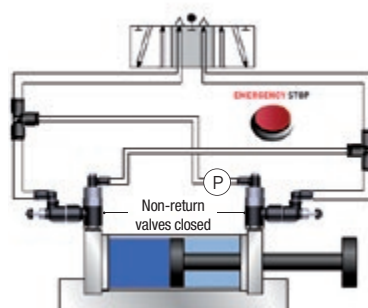

Drop/removal of pilot pressure (P) = cylinder rod locked

### Venting Operation

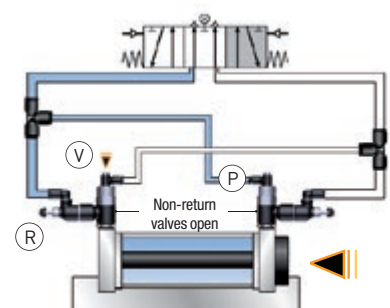

Venting (V) returns the cylinder rod to the start position, emptying the pressure chamber through the flow regulator (R) and pilot line (P)



# Piloted Non-Return Valves

## 7892 Piloted Non-Return Valve, Male BSPP Thread

Technical polymer, nickel-plated brass, NBR

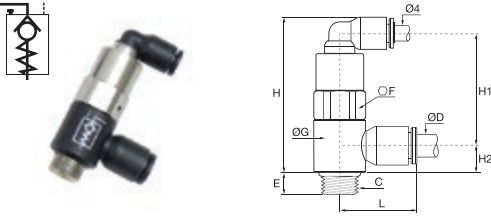

ØD	C		E	F	G	H	H1	H2	L	Kg
6	G1/8	<a href="#">7892 06 10</a>	6	13	14	42	30	7	21	0.020
	G1/4	<a href="#">7892 06 13</a>	9	17	18.5	45	32	9	23	0.042
8	G1/8	<a href="#">7892 08 10</a>	6	13	14	42	29	9	25	0.020
	G1/4	<a href="#">7892 08 13</a>	9	17	18.5	45	32	9	27	0.042
10	G3/8	<a href="#">7892 08 17</a>	6	20	22.5	57	41	11	28	0.093
	G3/8	<a href="#">7892 10 17</a>	6	20	22.5	57	41	11	31	0.144
12	G1/2	<a href="#">7892 10 21</a>	10	24	28	63	47	16	36	0.109
	G1/2	<a href="#">7892 12 21</a>	10	24	28	63	47	16	36	0.150

## 7894 Piloted Non-Return Valve with Flow Regulator and Exhaust, Male BSPP Thread

Technical polymer, nickel-plated brass

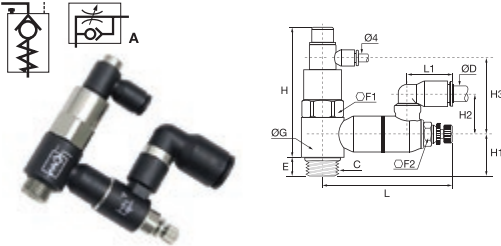

ØD	C		E	F1	F2	G	H	H1	H2	H3	L	L <sub>max</sub>	L1	Kg
6	G1/8	<a href="#">7894 06 10</a>	6	13	8	14	46	7	24	31	48.5	51	16	0.041
	G1/4	<a href="#">7894 06 13</a>	9	17	10	18.5	49	11	18	31	59.5	65	17	0.067
8	G1/8	<a href="#">7894 08 10</a>	6	13	8	14	46	7	27	31	48.5	51	22	0.051
	G1/4	<a href="#">7894 08 13</a>	9	17	10	18.5	49	11	23	31	59.5	65	23	0.068
10	G3/8	<a href="#">7894 08 17</a>	7	20	14	22.5	69	13	21	40	67.5	73	23	0.060
	G3/8	<a href="#">7894 10 17</a>	7	20	14	22.5	69	13	29	40	67.5	73	26	0.061
12	G1/2	<a href="#">7894 10 21</a>	9	24	17	28	76	12.5	26	47	74	81	26	0.234
	G1/2	<a href="#">7894 12 21</a>	9	24	17	28	76	12.5	27	47	74	81	30	0.237

## Related Product

### LF 3000® Push-In Fittings

#### Unequal Tee

P. 1-18



Model		Pilot and depilot threshold				
		2 bar	4 bar	6 bar	8 bar	10 bar
G1/8	Pilot Pressure	1.2	1.72	2.44	2.96	3.56
	Depilot Pressure	0.56	0.96	1.12	1.76	2.12
G1/4	Pilot Pressure	0.92	1.52	2.12	2.68	3.28
	Depilot Pressure	0.64	1.16	1.68	2.16	2.64
G3/8	Pilot Pressure	1.12	1.84	2.56	3.32	4.08
	Depilot Pressure	0.64	1.04	1.44	1.84	2.36
G1/2	Pilot Pressure	1.04	1.60	2.12	2.76	3.88
	Depilot Pressure	0.76	1.28	1.76	2.20	2.72

Maximum Flow at 6 bar (Nl/min)	7894 06 10	7894 06 13	7894 08 10	7894 08 13	7894 08 17	7894 10 17	7894 10 21	7894 12 21
Direction of Adjustment	250	475	240	585	875	940	1535	1560
Return	365	620	355	815	1085	1205	1860	1940



# Non-Return Valves

Non-return valves allow compressed air to flow in one direction and prevent it from flowing in the other. Fitted upstream of the circuit to be protected, they provide **total protection**.

## Product Advantages

- Variety of Applications**
  - Wide range
  - Push-in connection: ease of use
  - Available in threaded or push-in version
- Powerful Design**
  - Tried and tested durability according to DI 2006/42/CE
  - Lip seals for improved sealing performance
  - Excellent vibration resistance
  - Compact
  - Lightweight
  - Symbol showing the operating direction of flow
  - Safe installation with colour codes:
    - green push-button: supply version
    - red push-button: exhaust version



Automotive Process  
Robotics  
Vacuum  
Textile  
Semi-Conductors  
Packaging  
Pneumatics

Applications

## Technical Characteristics

<b>Compatible Fluids</b>	Compressed air	
<b>Working Pressure</b>	1 to 10 bar	
<b>Working Temperature</b>	0°C to +70°C	
<b>Cracking Pressure</b>	0.3 bar	
<b>Flow Characteristics (NI/min)</b>	<b>Model</b>	<b>Flow at 6 bar</b>
	4 mm	350
	6 mm	670
	8 mm	1080
	10 mm	2230
12 mm	2300	

### Component Materials

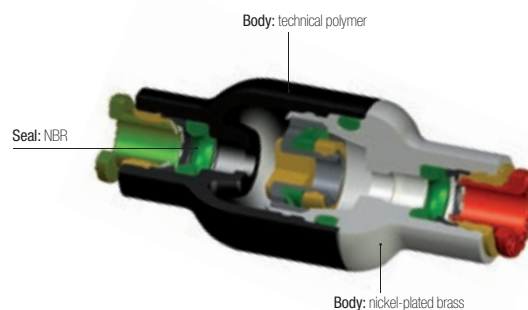

Silicone-free

### Regulations

DI: 2002/95/EC (RoHS)  
RG: 1907/2006 (REACH)  
DI: 97/23/EC (PED)

DI : 2006/42/EC (Machine Directive)  
test according to ISO 19973-5. B10d (1Hz)  
>40 millions of cycles

## Operation

### In-Line Version

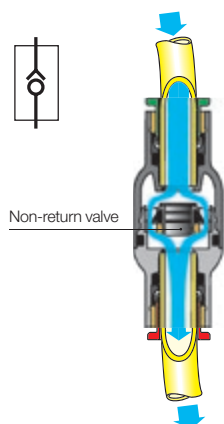

### Supply Version

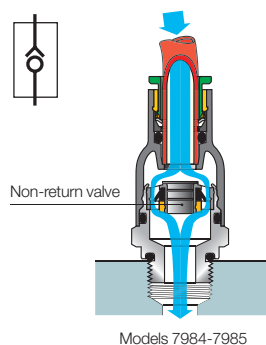

### Exhaust Version

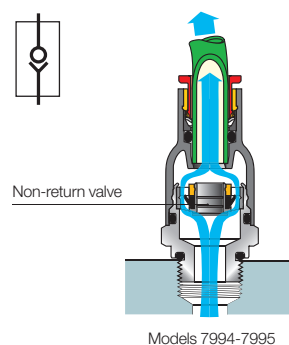

### Installation Diagram

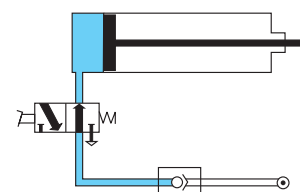

# Non-Return Valves

## 7996 In-Line Equal Non-Return Valve



Technical polymer, nickel-plated brass, NBR

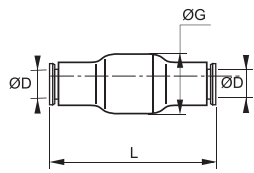

ØD		G	L	Kg
4	<a href="#">7996 04 00</a>	16	38.5	0.008
6	<a href="#">7996 06 00</a>	16	41	0.013
8	<a href="#">7996 08 00</a>	19	51.5	0.017
10	<a href="#">7996 10 00</a>	23	63.5	0.070
12	<a href="#">7996 12 00</a>	23	66.5	0.050

## 7984 In-Line Non-Return Valve, Supply, Male BSPP and Metric Thread



Technical polymer, nickel-plated brass, NBR

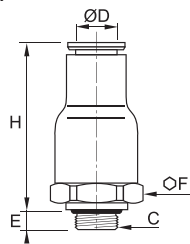

ØD	C		E	F	H	Kg
4	M5x0.8	<a href="#">7984 04 19</a>	3	9	32	0.008
	G1/8	<a href="#">7984 04 10</a>	5	16	28.5	0.015
6	G1/4	<a href="#">7984 06 13</a>	5.5	16	30.5	0.015
	G1/8	<a href="#">7984 08 10</a>	5	19	36	0.021
8	G1/4	<a href="#">7984 08 13</a>	5.5	19	36	0.023
	G3/8	<a href="#">7984 10 17</a>	5.5	23	42	0.047
12	G3/8	<a href="#">7984 12 17</a>	5.5	23	42	0.010
	G1/2	<a href="#">7984 12 21</a>	7.5	23	44	0.041

## 7994 In-Line Non-Return Valve, Exhaust, Male BSPP and Metric Thread



Technical polymer, nickel-plated brass, NBR

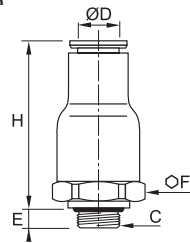

ØD	C		E	F	H	Kg
4	M5x0.8	<a href="#">7994 04 19</a>	3	9	32	0.790
	G1/8	<a href="#">7994 04 10</a>	5	16	28.5	0.018
6	G1/8	<a href="#">7994 06 10</a>	5	16	30.5	0.015
	G1/4	<a href="#">7994 06 13</a>	5.5	16	30.5	0.015
8	G1/8	<a href="#">7994 08 10</a>	5	19	36	0.023
	G1/4	<a href="#">7994 08 13</a>	5.5	19	36	0.023
10	G3/8	<a href="#">7994 10 17</a>	5.5	23	42	0.050
	G3/8	<a href="#">7994 12 17</a>	5.5	23	42	0.043
12	G1/2	<a href="#">7994 12 21</a>	7.5	23	44	0.045

## 7985 In-Line Non-Return Valve, Supply, Male BSPT Thread



Technical polymer, nickel-plated brass, NBR

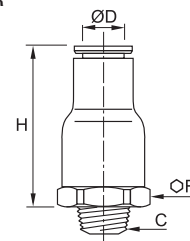

ØD	C		F	H	Kg
4	R1/8	<a href="#">7985 04 10</a>	16	28.5	0.016
	R1/8	<a href="#">7985 06 10</a>	16	30.5	0.016
6	R1/4	<a href="#">7985 06 13</a>	16	30.5	0.021
	R1/8	<a href="#">7985 08 10</a>	19	36	0.022
8	R1/4	<a href="#">7985 08 13</a>	19	36	0.020
	R3/8	<a href="#">7985 10 17</a>	23	42	0.049
12	R3/8	<a href="#">7985 12 17</a>	23	42	0.042
	R1/2	<a href="#">7985 12 21</a>	23	44	0.048

Pre-coated thread

## 7995 In-Line Non-Return Valve, Exhaust, Male BSPT Thread



Technical polymer, nickel-plated brass, NBR

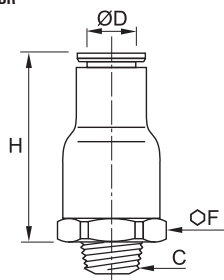

ØD	C		F	H	Kg
4	R1/8	<a href="#">7995 04 10</a>	16	28.5	0.015
	R1/8	<a href="#">7995 06 10</a>	16	30.5	0.016
6	R1/4	<a href="#">7995 06 13</a>	16	30.5	0.022
	R1/8	<a href="#">7995 08 10</a>	19	36	0.022
8	R1/4	<a href="#">7995 08 13</a>	19	36	0.026
	R3/8	<a href="#">7995 10 17</a>	23	42	0.048
12	R3/8	<a href="#">7995 12 17</a>	23	42	0.042
	R1/2	<a href="#">7995 12 21</a>	23	44	0.048

Pre-coated thread

# Nickel-Plated Brass Adjustable Non-Return Valves

These nickel-plated brass adjustable non-return valves, suitable for **harsh environments**, allow compressed air to flow in one direction and prevent flow in the other. This product incorporates **precise adjustment** of opening pressure for greater flexibility.

## Product Advantages

<b>Robust</b>	Excellent resistance to abrasion and corrosion Developed for the food process industry
<b>Optimised Inventory Management</b>	A single valve for multiple opening pressure settings Limits the number of versions Flexibility of use
<b>Protection &amp; Safety</b>	Maintains downstream pressure if upstream pressure drops Designed with locking nut to protect initial setting in the event of: <ul style="list-style-type: none"> <li>vibration</li> <li>intensive use</li> <li>accidental handling</li> </ul> Adjustment and locking of the non-return valve cracking pressure with two different Allen keys prevents the settings from being accidentally changed Smooth external profile to facilitate cleaning in situ Maximum constant flow guaranteed whatever the setting of the cracking pressure



**Applications**

- Printing
- Machine Tools
- Food Process
- Petrochemical
- Textile
- Automotive Process
- Chemical

## Technical Characteristics

<b>Compatible Fluids</b>	Compressed air					
<b>Working Pressure</b>	0 to 12 bar					
<b>Working Temperature</b>	-20°C to +80°C					
<b>Cracking Pressure</b>	Threads	0 to 4 turns (values given as an example only)				
	M5x0.8 - G1/8 - G1/4	1 to 0.10 bar				
	G3/8	1 to 0.15 bar				
	G1/2	1 to 0.20 bar				
<b>Max. Tightening Torques</b>	Threads	M5x0.8	G1/8	G1/4	G3/8	G1/2
	daN.m	0.16	0.8	1.2	3	3.5

### Component Materials

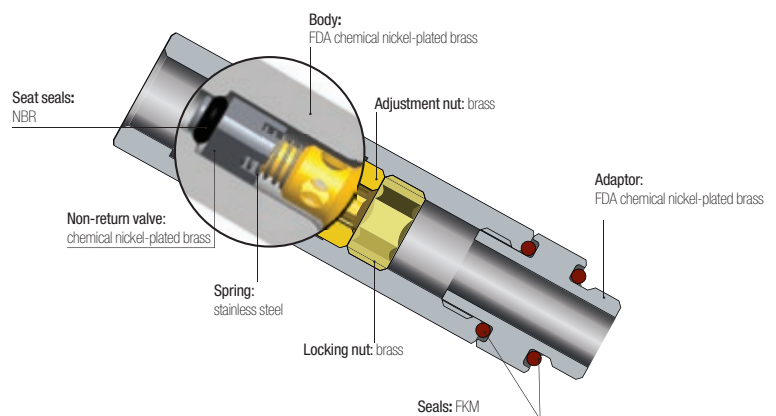

**Silicone-free**

### Regulations

DI: 2002/95/EC (RoHS)  
RG: External Components: 21CFR (FDA)  
(seal: § 177.2600, nickel: §184.1537, grease: NSF H1)  
RG: 1935/2004 (external surface flow ≥ 0.02 litre per hour)

DI: 2006/42/EC (external surface Ra < 0.8 µm)  
RG: 1907/2006 (REACH)  
DI: 2006/42/EC (Machine Directive) test according to ISO 19973-5. B10d (1Hz) >70 millions of cycles

## Operation

### Step 1

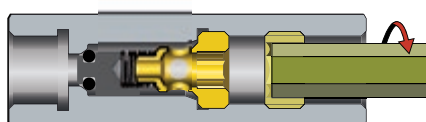

Unscrew the locking nut with an Allen key.

### Step 2

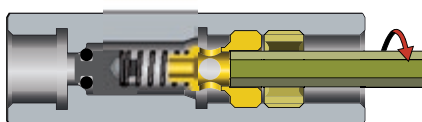

Unscrew the adjustment nut with a smaller Allen key to adjust the cracking pressure. The number of turns adjusts the cracking pressure from 1 bar to 0.10 bar.

### Step 3

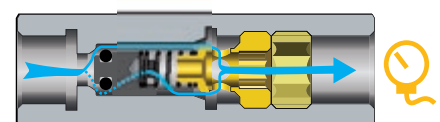

Tighten the locking nut with the Allen key to lock the cracking pressure setting. Then, control the pressure with a pressure gauge downstream.

# Nickel-Plated Brass Adjustable Non-Return Valves

## 7930 Adjustable Check Valve, Double Female BSPP and Metric Thread

FDA chemical nickel-plated brass, FKM

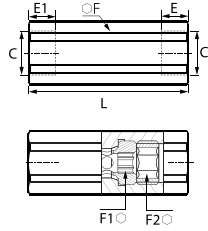

C		E	E1	F	F1	F2	L	Kg
M5x0.8	<a href="#">7930 19 19</a>	8	4	13	4	6	49	0.055
G1/8	<a href="#">7930 10 10</a>	8	6	13	4	6	45	0.033
G1/4	<a href="#">7930 13 13</a>	10	7.5	16	6	8	54	0.073
G3/8	<a href="#">7930 17 17</a>	11	8.5	20	8	10	61.5	0.163
G1/2	<a href="#">7930 21 21</a>	13	10	24	10	12	73	0.171

## 7931 Adjustable Check Valve Supply, Male/Female BSPP Thread

FDA chemical nickel-plated brass, FKM

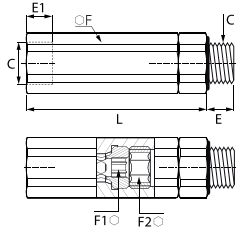

C		E	E1	F	F1	F2	L	Kg
G1/8	<a href="#">7931 10 10</a>	5.5	6	13	4	6	51.5	0.043
G1/4	<a href="#">7931 13 13</a>	6.5	7.5	16	6	8	61.5	0.208
G3/8	<a href="#">7931 17 17</a>	7.5	8.5	20	8	10	70	0.125
G1/2	<a href="#">7931 21 21</a>	9	10	24	10	12	82.5	0.212

## 7932 Adjustable Check Valve Exhaust, Male/Female BSPP Thread

FDA chemical nickel-plated brass, FKM

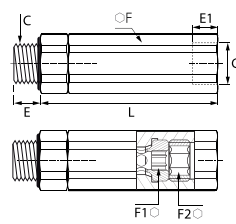

C		E	E1	F	F1	F2	L	Kg
G1/8	<a href="#">7932 10 10</a>	5.5	8	13	4	6	51.5	0.009
G1/4	<a href="#">7932 13 13</a>	6.5	10	16	6	8	61.5	0.058
G3/8	<a href="#">7932 17 17</a>	7.5	11	20	8	10	70	0.123
G1/2	<a href="#">7932 21 21</a>	9	13	24	10	12	82.5	0.212

# LIQUIfit® Non-Return Valves

LIQUIfit® non-return valves meet the requirements for conveying **beverages**. They allow flow in one direction and prevent any return flow. Fitted in the circuit, they provide **total protection**.

## Product Advantages

### Suitable for Beverage Applications

- Fully compatible for use with water, beverages and liquid foodstuffs (liquids and gas)
- Very low cracking threshold
- Excellent chemical compatibility
- Resistant to cleaning products
- Hygienic design with smooth surfaces
- Fluid direction indicated
- EPDM sealing technology



Water Softeners  
Water Treatment  
Water Purification  
Drinks Dispensers  
Hot & Cold Water Systems

Applications

## Technical Characteristics

<b>Compatible Fluids</b>	Water, beverages, liquid foodstuffs
<b>Working Pressure</b>	1 to 10 bar
<b>Working Temperature</b>	0°C to +65°C
<b>Cracking Pressure</b>	0.02 bar

### Component Materials



Silicone-free

### Regulations

DI: 2002/95/EC (RoHS), 2011/65/EC  
FDA: 21 CFR 177.1550  
NSF 51 (referenced material)  
NSF 61  
RG: 1907/2006 (REACH)

# LIQUIfit® Non-Return Valves

**7992**

Single Non-Return Valve



POM, EPDM

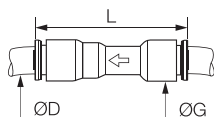

ØD		G	L	Kg
1/4	<a href="#">7992 56 00WP2</a>	17	51	0.008
5/16	<a href="#">7992 08 00WP2</a>	18	53	0.010
3/8	<a href="#">7992 60 00WP2</a>	20	55	0.011
1/2	<a href="#">7992 62 00WP2</a>	23	68	0.021

## Associated Products

The full range of LIQUIfit® products can be found in this catalogue:

- Push-in fittings for metric and inch tubing (Chapter 1)
- Valves (Chapter 6)

To complement the LIQUIfit® range, Parker Legris Advanced PE tubing (Chapter 3) is suited to the most demanding environments, approved for permanent contact with beverage and food products, as well as for water treatment.

# Stainless Steel Non-Return Valves

Stainless steel non-return valves are ideally suited to **harsh environments** and for conveying **many industrial fluids**. These products allow fluids to flow in one direction and prevent them from flowing in the other.

## Product Advantages

**Demanding Environments** | Robust design  
 Suitable for use with many chemicals or in corrosive environments  
 Compatible with many fluids

**Compact & Versatile** | Reduced dimensions  
 Smooth external surfaces contribute to equipment cleanliness  
 Flow direction symbol protects against incorrect installation  
 Hexagonal body to facilitate installation



**Applications**  
 Pneumatics  
 Machine Tools  
 Food Process  
 Printing  
 Chemical  
 Textile  
 Automotive Process

## Technical Characteristics

<b>Compatible Fluids</b>	Many fluids
<b>Working Pressure</b>	0.5 to 40 bar
<b>Working Temperature</b>	-20°C to +180°C

<b>Flow Characteristics</b>	Threads	NI/min	Kv
	G1/8	18.88	1.60
	G1/4	19.91	1.69
	G3/8	35.54	3.01
	G1/2	36.50	3.10
	G3/4	65.86	5.59
G1	92.60	7.86	
<b>Cracking Pressure</b>	0.25 bar		

### Component Materials

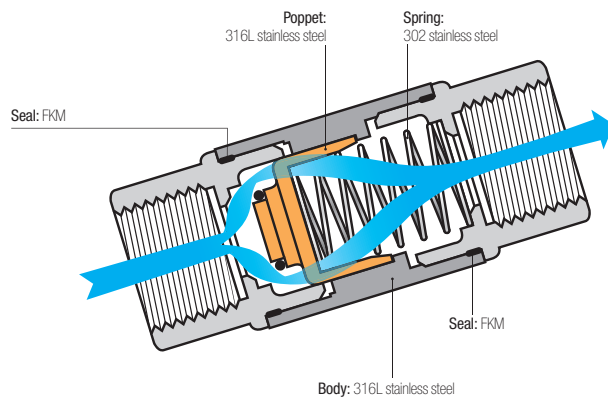

**Silicone-free**

### Regulations

DI: 2002/95/EC (RoHS)  
 RG: 1907/2006 (REACH)  
 DI: 97/23/EC (PED)

# Stainless Steel Non-Return Valves

## 4890 Non-Return Valve, Female BSPP Thread



Stainless steel 316L, FKM

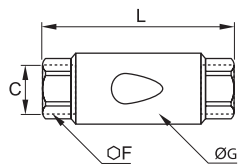

C	DN		F	G	L	Kg
G1/8	10	<a href="#">4890 10 10</a>	17	22	50	0.082
G1/4	10	<a href="#">4890 13 13</a>	17	22	50	0.074
G3/8	15	<a href="#">4890 17 17</a>	22	30	67	0.182
G1/2	15	<a href="#">4890 21 21</a>	24	30	71	0.183
G3/4	20	<a href="#">4890 27 27</a>	32	42	84	0.289
G1	25	<a href="#">4890 34 34</a>	38	42	90	0.420

## 4891 Non-Return Valve, Supply, Male BSPP Thread/Exhaust, Female BSPP Thread



Stainless steel 316L, FKM

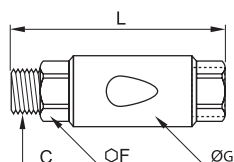

C	DN		F	G	L	Kg
G1/8	10	<a href="#">4891 10 10</a>	17	22	56	0.100
G1/4	10	<a href="#">4891 13 13</a>	17	22	58	0.082
G3/8	15	<a href="#">4891 17 17</a>	22	30	75	0.191
G1/2	15	<a href="#">4891 21 21</a>	24	30	79	0.210
G3/4	20	<a href="#">4891 27 27</a>	32	42	84	0.300
G1	25	<a href="#">4891 34 34</a>	38	42	102	0.519

## 4892 Non-Return Valve, Supply, Female BSPP Thread/Exhaust, Male BSPP Thread



Stainless steel 316L, FKM

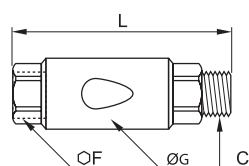

C	DN		F	G	L	Kg
G1/8	10	<a href="#">4892 10 10</a>	17	22	56	0.100
G1/4	10	<a href="#">4892 13 13</a>	17	22	58	0.082
G3/8	15	<a href="#">4892 17 17</a>	22	30	75	0.192
G1/2	15	<a href="#">4892 21 21</a>	24	30	79	0.211
G3/4	20	<a href="#">4892 27 27</a>	32	42	84	0.300
G1	25	<a href="#">4892 34 34</a>	38	42	102	0.519

## 4895 Non-Return Valve, Female NPT Thread



Stainless steel 316L, FKM

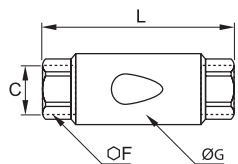

C	DN		F	G	L	Kg
NPT1/8	10	<a href="#">4895 11 11</a>	17	22	50	0.083
NPT1/4	10	<a href="#">4895 14 14</a>	17	22	54	0.079
NPT3/8	15	<a href="#">4895 18 18</a>	22	30	67	0.197
NPT1/2	15	<a href="#">4895 22 22</a>	24	30	77	0.196



# Soft Start Fittings

These fittings protect your system by preventing sudden shocks. On start-up, they control the **pressure increase** in the downstream circuit; this helps **prevent the risk** of industrial accidents.

## Product Advantages

- Protection of Equipment & Personnel**
  - Prevents the risk of damage after any stoppage which requires the system to be vented
  - Returns the control valve to its initial position in total safety
  - Adjustment of the pressurisation speed
  - Protects the adjustment mechanism using a recessed adjustment screw
- Mounted on FRL**
  - Models 7860 and 7861: yellow identification washer
  - Protection for the whole system
  - Simultaneous pressurisation speed of the whole system
- Mounted on Control Valve**
  - Models 7870 and 7871: black identification washer
  - Protection of individual circuits
  - Mounted on the control valve, it optimises the pressurisation speed of a specific cylinder



**Applications**

- Pneumatic Systems
- Robotics
- Textile
- Semi-Conductors
- Packaging
- Pneumatics

## Technical Characteristics

<b>Compatible Fluids</b>	Compressed air
<b>Working Pressure</b>	3 to 10 bar
<b>Working Temperature</b>	-15°C to +60°C

Max. Tightening Torques	Threads	daN.m
	G1/4	1.3
G3/8	1.5	
G1/2	1.8	

Flow Characteristics	Model	Flow at 6 bar	Kv
	7860 08 13	1500 NI/min	0.80
7860 10 13	2100 NI/min	1.20	
7860 10 17	2200 NI/min	1.30	
7860 12 17	3100 NI/min	1.00	
7860 12 21	3100 NI/min	1.00	
7861 13 13	2100 NI/min	1.20	
7861 17 17	3100 NI/min	1.00	
7861 21 21	3100 NI/min	1.00	
7870 08 13	1500 NI/min	0.80	
7870 10 13	2000 NI/min	1.15	
7870 10 17	2000 NI/min	1.15	
7871 13 13	2000 NI/min	1.15	
7871 17 17	2000 NI/min	1.15	

### Component Materials

Internal seal: NBR



Screw: nickel-plated brass

Body: technical polymer or nickel-plated brass

Washer: technical polymer

### Silicone-free

### Regulations

- DI: 2002/95/CE (RoHS)
- RG: 1907/2006 (REACH)
- DI: 97/23/CE (PED)

## Operation

### Filter, Regulator, Lubricator

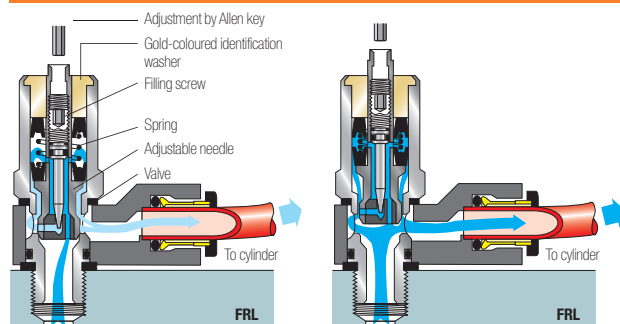

### Control Valve

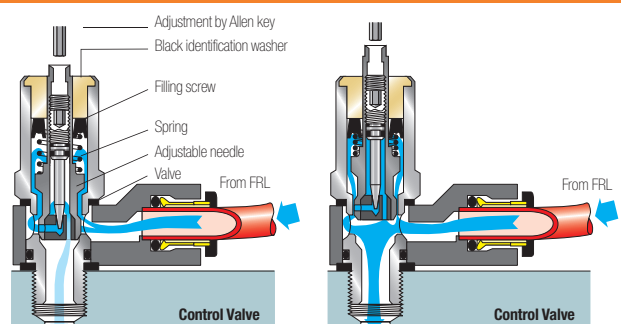

# Soft Start Fittings

## 7860 Soft Start Fitting for Isolating Valve, Male BSPP Thread

Technical polymer, nickel-plated brass, NBR

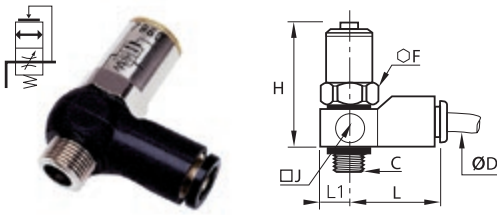

ØD	C		F	H <sub>min</sub>	H <sub>max</sub>	J	L	L1	Kg
8	G1/4	<a href="#">7860 08 13</a>	17	54	61	20	35	10	0.064
10	G1/4	<a href="#">7860 10 13</a>	22	55	62	25	41	12.5	0.112
	G3/8	<a href="#">7860 10 17</a>	22	55	62	25	41	12.5	0.115
12	G3/8	<a href="#">7860 12 17</a>	22	55	62	25	45	12.5	0.125
	G1/2	<a href="#">7860 12 21</a>	22	63.5	70.5	25	45	12.5	0.152

## 7861 Soft Start Fitting for Isolating Valve, Male/Female BSPP Thread

Nickel-plated brass, NBR, technical polymer



C		F	H <sub>min</sub>	H <sub>max</sub>	J	L	L1	Kg
G1/4	<a href="#">7861 13 13</a>	22	54	62	24	31	12	0.147
G3/8	<a href="#">7861 17 17</a>	22	55	62	24	31	12	0.139

## 7870 Soft Start Fitting for Control Valve, Male BSPP Thread

Technical polymer, nickel-plated brass, NBR

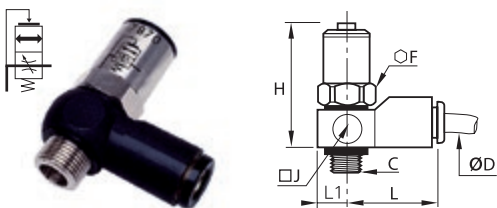

ØD	C		F	H <sub>min</sub>	H <sub>max</sub>	J	L	L1	Kg
8	G1/4	<a href="#">7870 08 13</a>	17	54	61	20	35	10	0.066
10	G1/4	<a href="#">7870 10 13</a>	22	55	62	25	41	12.5	0.113
	G3/8	<a href="#">7870 10 17</a>	22	55	62	25	41	12.5	0.116

## 7871 Soft Start Fitting for Control Valve, Male/Female BSPP Thread

Nickel-plated brass, NBR, technical polymer



C		F	H <sub>min</sub>	H <sub>max</sub>	J	L	L1	Kg
G1/4	<a href="#">7871 13 13</a>	22	55	62	24	31	12	0.149
G3/8	<a href="#">7871 17 17</a>	22	55	62	24	31	12	0.141

### Adjustment of the Filling Screw

Adjusting the screw to regulate the flow of air optimises the time taken to pressurise depending on the air volume to be refilled and the system requirements.

To adjust:

- immobilise the piston using a spanner
- adjust the screw with an Allen key
  - 1.5 mm key for 8 mm diameter
  - 2.5 mm key for 10 and 12 mm diameter

Max. tightening torque: 0.1 daN.m

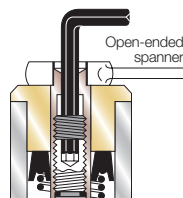

### Cylinder Pressure Cycle

When the downstream pressure reaches 2/3 of the supply pressure, full flow is automatically established

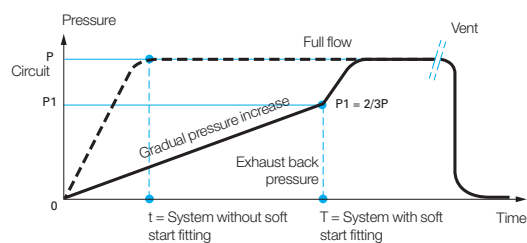

# Pneumatic Sensor Fittings

The sensor detects the pressure drop when a cylinder reaches the end of its stroke. They produce a **pneumatic or electric output signal** when the pressure drop in the exhaust chamber of the cylinder goes below their back pressure threshold.

## Product Advantages

**Easy-to-Use** | Suited to changes of series: no adjustment to position detectors is necessary

**With Pneumatic Output** | Totally pneumatic installation  
 2 possible installations:  
 • Supplied with permanent pressure (P1): produces a pneumatic signal when the back pressure threshold is reached  
 • Supplied from the control valve-cylinder circuit on the opposite side: no unexpected pneumatic signal (S) can appear during pressurisation due to the actuating pressure which supplies the sensor fitting (P1)

**With Electrical Output** | Combined electrical and pneumatic installation  
 Installation with continuous electrical supply only (BU)  
 Guarantees an electrical signal when the back pressure threshold is reached



**Applications**  
 Robotics  
 Textile  
 Semi-Conductors  
 Packaging  
 Pneumatics

## Technical Characteristics

<b>Compatible Fluids</b>	Compressed air
<b>Working Pressure</b>	3 to 8 bar
<b>Working Temperature</b>	-15°C to +60°C
<b>Back Pressure</b>	0.85 to 1 bar
<b>Switching Time</b>	Model 7818: 3 ms
<b>Open/Closed Contact</b>	Model 7828: 2A / 0-48 V 2A / 250 V 50 Hz

### Component Materials

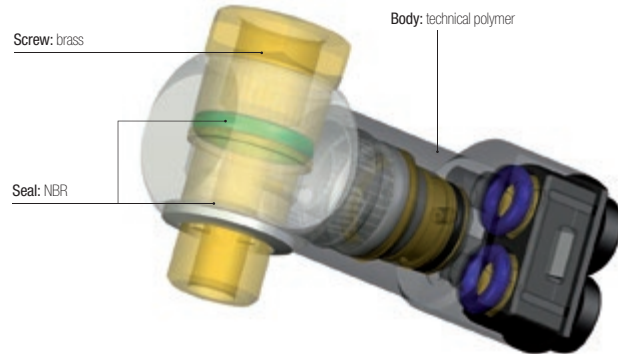

**Silicone-free**

### Regulations

DI: 2002/95/EC (RoHS)  
 RG: 1907/2006 (REACH)  
 DI: 97/23/EC (PED)

## Operation

### Pneumatic Installation Diagram



P': Exhaust back pressure  
 P: Dynamic pressure  
 P1: Sensor supply pressure  
 S: Output signal

### Electrical Installation Diagram

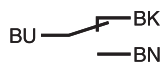

Connection via 3 core 0.5 mm<sup>2</sup> cable, 2 meters long.  
 Contactor: 5A / 250 V ~ or 5W / 48 V ==

### Cylinder in Operation

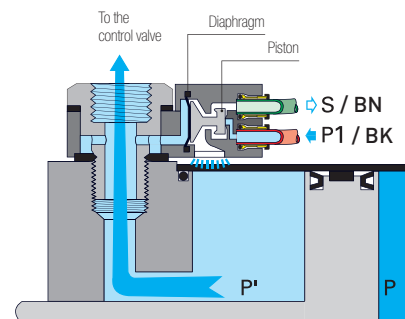

### Cylinder in Final Position

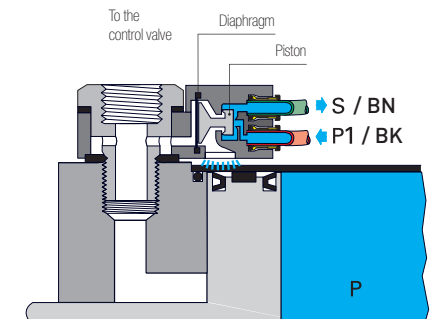

# Pneumatic Sensor Fittings

## 7818 Pneumatic Sensor Fitting, Male BSPP and Metric Thread



Zamak, NBR, technical polymer, brass

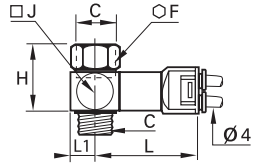

ØD	C	F	H	J	L	L1	Kg
M5x0.8	<a href="#">7818 04 19*</a>	8	16	11	43.5	5.5	0.025
G1/8	<a href="#">7818 04 10</a>	14	23	16	44.5	8	0.043
G1/4	<a href="#">7818 04 13</a>	17	28	19.5	46.5	10	0.061
G3/8	<a href="#">7818 04 17</a>	22	29	23.5	49	12	0.083
G1/2	<a href="#">7818 04 21</a>	27	30	31.5	52.5	16	0.125

\* Bolt zinc passivated steel

## 7818 Pneumatic Sensor, Male/Female BSPP Thread



Zamak, NBR, technical polymer, brass

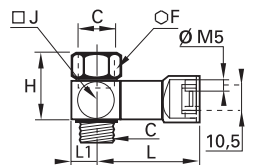

C	F	H	J	L	L1	Kg	
G1/8	<a href="#">7818 19 10</a>	14	23	16	40.5	8	0.049
G1/4	<a href="#">7818 19 13</a>	17	28	19.5	42.5	10	0.065

## 7828 Pneumatic/Electric Sensor, Male/Female BSPP and Metric Thread



Technical polymer, NBR, brass

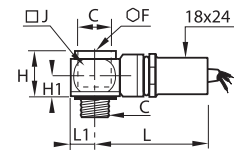

C	F	H	H1	J	L	L1	Kg
M5x0.8	<a href="#">7828 00 19</a>	8	20	10	49	5.5	0.116
G1/8	<a href="#">7828 00 10</a>	6	20	10	52	8	0.132
G1/4	<a href="#">7828 00 13</a>	8	20	10	54	10.5	0.140
G3/8	<a href="#">7828 00 17</a>	10	22	12	57	14	0.184
G1/2	<a href="#">7828 00 21</a>	12	26	14	58	16.5	0.206

### Cylinder Pressure Cycle

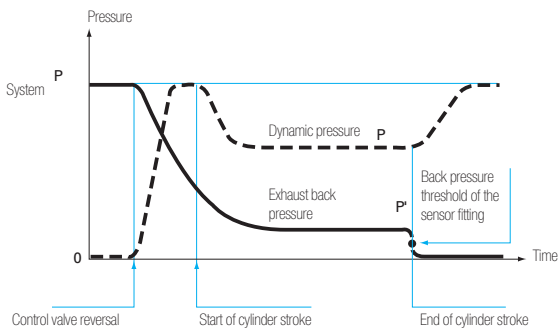

### Installation Diagram

Depending on model, S1, S2 and P1 may be pneumatic or electric. See the installation diagrams opposite.

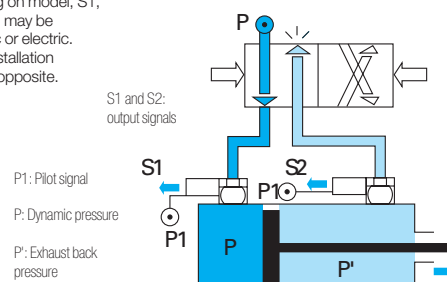

# Pressure Regulators

Parker Legris pressure regulators **stabilise at the maximum determined value** the pressure delivered to the pneumatic equipment, whatever the fluctuations of the pressure upstream.

## Product Advantages

**Ergonomics** | Easy adjustment of the output pressure through the knurled screw  
 Lockable adjustment possible  
 Output pressure adjustment options marked on the screw

**Energy Savings** | Setting of the optimum pressure enables the equipment to function correctly  
 Installation in a manifold allows optimum output pressures to be delivered to specific parts of the circuit  
 Designed for applications where cylinder force needs to be controlled: marking, sleeving, crimping cylinders etc.



Robotics  
 Textile  
 Semi-Conductors  
 Packaging  
 Pneumatics

Applications

## Technical Characteristics

<b>Compatible Fluids</b>	Compressed air
<b>Working Pressure</b>	Upstream pressure: 1 to 16 bar Downstream pressure: 1 to 8 bar
<b>Working Temperature</b>	-10°C to +70°C

<b>Max. Tightening Torques</b>	Threads	G1/8	G1/4	G3/8
	daN.m	0.4	0.5	0.6

### Component Materials



Silicone-free

### Regulations

DI: 2002/95/EC (RoHS)  
 RG: 1907/2006 (REACH)  
 DI: 97/23/EC (PED)

## Operation

### Mounting Upstream of the Control Valve

Adjustment of the piston feed pressure in both directions

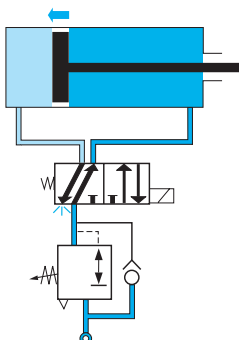

### Mounting Downstream of the Control Valve

**Phase 1:** adjustment of the piston speed in a single direction

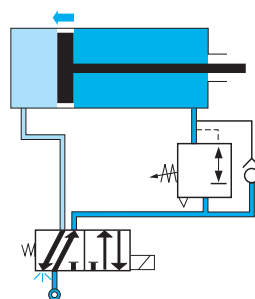

**Phase 2:** in return direction, pressure is supplied through the control valve

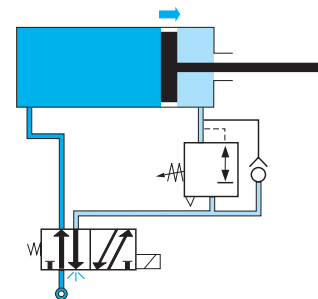

# Pressure Regulators

## 7300 Pressure Regulator, Male BSPP Thread

Technical polymer, nickel-plated brass, NBR

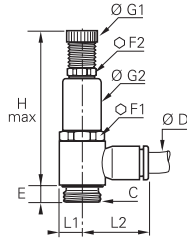

ØD	C		E	F1	F2	G1	G2	H <sub>max</sub>	L1	L2	Kg
4	G1/8	<a href="#">7300 04 10</a>	4.5	17	13	14	17	65	7	18.5	0.047
6	G1/8	<a href="#">7300 06 10</a>	4.5	17	13	14	17	65	7	20	0.047
	G1/4	<a href="#">7300 06 13</a>	7.5	17	13	14	17	74.5	9.5	22	0.065
8	G1/8	<a href="#">7300 08 10</a>	4.5	17	13	14	17	65	7	25	0.048
	G1/4	<a href="#">7300 08 13</a>	7.5	17	13	14	17	74.5	9.5	27	0.066
10	G3/8	<a href="#">7300 08 17</a>	8.5	22	17	18.5	22	84	11.5	28.5	0.122
	G1/4	<a href="#">7300 10 13</a>	7.5	17	13	14	17	74.5	9.5	29	0.067
	G3/8	<a href="#">7300 10 17</a>	8.5	22	17	18.5	22	84	11.5	30.5	0.122

### Flow Characteristics at 7 bar (Nl/min)

#### G1/8 Models

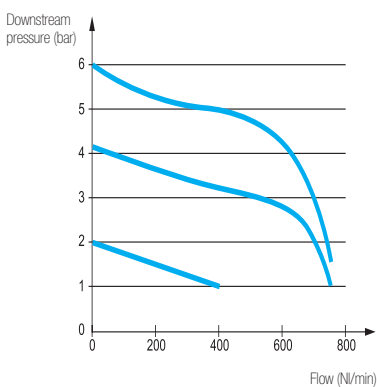

#### G1/4 Models

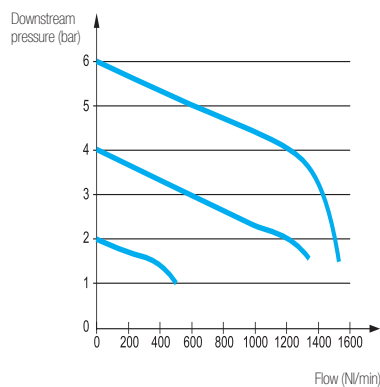

#### G3/8 Models

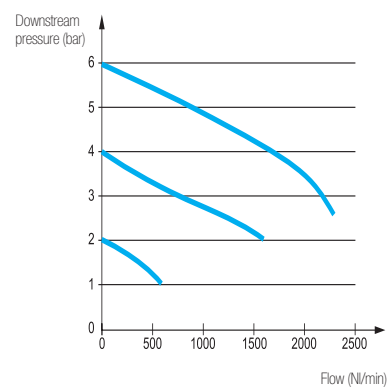

# Pressure Reducers

Parker Legris pressure reducers are designed to **set the pressure** of a compressed air circuit to a determined value. They therefore enable **energy saving** by limiting the cylinder pressure.

## Product Advantages

### Design & Performance

- Optimisation of the pressure at the minimum values required to provide final force and energy consumption
- Manual adjustment protected by a plug
- Visual indication of the differential pressure by colour code

### Two Models Available

- Banjo: fitted directly on the control valve or terminal block
- In-line: fitted in the pipework, between the control valve and cylinder



Applications

- Robotics
- Textile
- Semi-Conductors
- Packaging
- Pneumatics

## Technical Characteristics

<b>Compatible Fluids</b>	Compressed air				
<b>Working Pressure</b>	1 to 8 bar				
<b>Working Temperature</b>	-15°C to +60°C				
<b>Max. Tightening Torques for Models 7318 and 7471</b>	Threads	G1/8	G1/4	G3/8	G1/2
	daN.m	0.8	1.2	3	3.5

### Component Materials

Internal seals: NBR

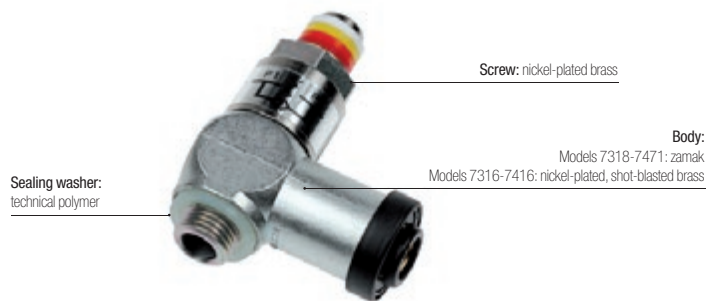

Silicone-free

### Regulations

DI: 2002/95/EC (RoHS)  
 RG: 1907/2006 (REACH)  
 DI: 97/23/EC (PED)

## Operation

### Installation Diagram

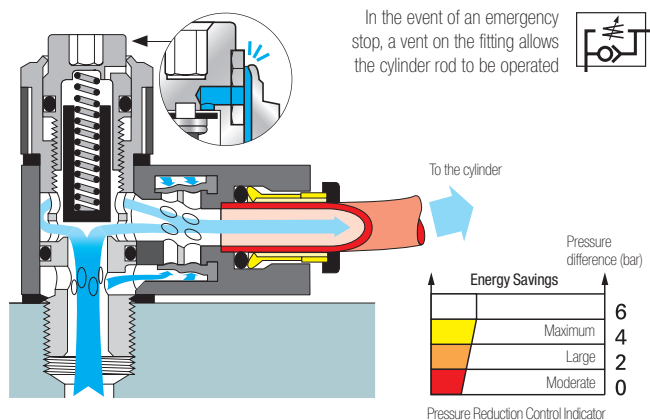

### Cylinder Pressure Cycle

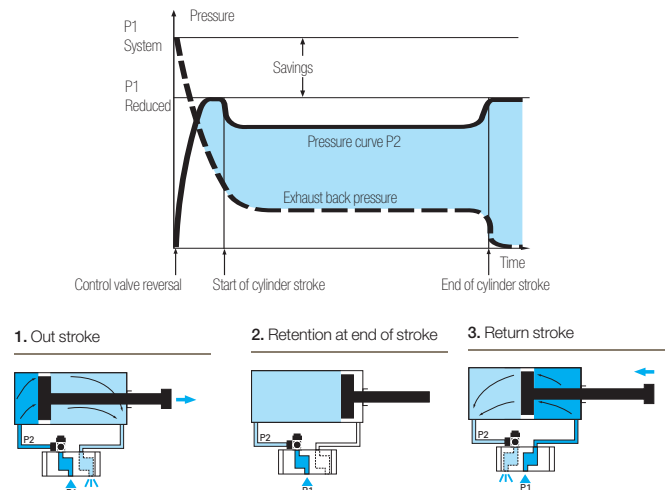

### Manual Adjustment

To ease access to the adjustment, Parker Legris has designed a plug-in manual control system.

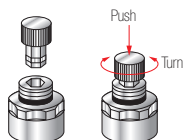

To prevent access to the setting mechanism, a sealing plug may be used.

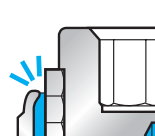

This may be removed if necessary as follows:

1. Pierce the centre
2. Remove the plug



# Pressure Reducers

## 7318 Banjo Pressure Reducer, Male BSPP Thread



Zamak, NBR, technical polymer, nickel-plated brass

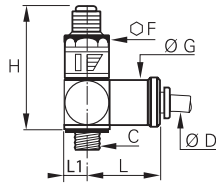

ØD	C		F	G	H <sub>min</sub>	H <sub>max</sub>	L	L1	Kg
6	G1/8	<a href="#">7318 06 10</a>	19	20	49	57	43	10.5	0.137
	G1/4	<a href="#">7318 06 13</a>	19	20	49	57	43	10.5	0.135
8	G1/4	<a href="#">7318 08 13</a>	19	20	49	57	40	10.5	0.134
	G1/4	<a href="#">7318 10 13</a>	27	20	55	64	50	14	0.250
10	G3/8	<a href="#">7318 10 17</a>	27	26	55	94	50	14	0.253

## 7471 Banjo Pressure Reducer, Male/Female BSPP Thread



Zamak, NBR, technical polymer, nickel-plated brass

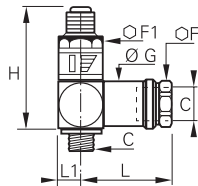

C		F	F1	G	H <sub>min</sub>	H <sub>max</sub>	L	L1	Kg
G1/8	<a href="#">7471 10 10</a>	19	19	20	49	57	45	10.5	0.160
G1/4	<a href="#">7471 13 13</a>	19	19	20	49	57	45	10.5	0.149
G3/8	<a href="#">7471 17 17</a>	24	27	26	55	64	56	14	0.288
G1/2	<a href="#">7471 21 21</a>	30	30	31	75	86	63	16.5	0.502

## 7316 In-Line Tube-to-Tube Pressure Reducer



Nickel-plated brass, NBR, technical polymer

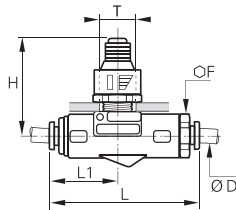

ØD		F	H <sub>min</sub>	H <sub>max</sub>	L	L1	ØT	Kg
6	<a href="#">7316 06 00</a>	22	49	57	74	32	18.5	0.214
8	<a href="#">7316 08 00</a>	22	49	57	71	32	18.5	0.199
10	<a href="#">7316 10 00</a>	27	61	70	89	41	22.5	0.411

## 7416 In-Line Pressure Reducer, Female BSPP Thread



Nickel-plated brass, NBR

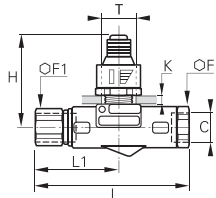

C		F	F1	H <sub>min</sub>	H <sub>max</sub>	K	L	L1	ØT	Kg
G1/8	<a href="#">7416 10 10</a>	17	19	49	57	4	74	35	18.5	0.213
G1/4	<a href="#">7416 13 13</a>	17	19	49	57	4	83	44	18.5	0.214
G3/8	<a href="#">7416 17 17</a>	22	27	61	70	5	90	44	22.5	0.399
G1/2	<a href="#">7416 21 21</a>	27	30	75	86	7	119	61	22.5	0.651

## 7000 Sealing Plug for Pressure Reducer

Technical polymer



		G	Kg
<a href="#">7000 00 01</a>		8	0.001

## 7000 Manual Ratchet Control for Pressure Reducer

Nickel-plated brass, NBR

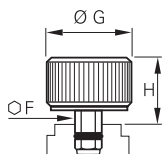

		F	G	H	Kg
<a href="#">7000 00 00</a>		6	22	15	0.040



# Snap Fittings

The snap fittings enable a **circuit to be isolated** without the need to vent the complete system. They are designed to facilitate repeated connections and disconnections in total safety.



## Product Advantages

### Performance & Safety

- Partial venting of systems while work is carried out
- Energy and time-saving during maintenance operations
- Protection of individuals by maintaining pressure if necessary
- Audible click indicates connection
- Circuit identification by coloured rings (on request)

**Applications**

- Control Panels
- Robotics
- Semi-Conductors
- Packaging
- Pneumatics
- Automotive Process

## Technical Characteristics

<b>Compatible Fluids</b>	Compressed air
<b>Working Pressure</b>	0 to 10 bar
<b>Working Temperature</b>	-20°C to +80°C
<b>Flow Characteristics at 6 bar</b>	DN 5 mm: 1000 NI/min DN 7 mm: 1900 NI/min

### Regulations

DI: 2002/95/EC (RoHS)  
RG: 1907/2006 (REACH)  
DI: 97/23/EC (PED)

### Component Materials

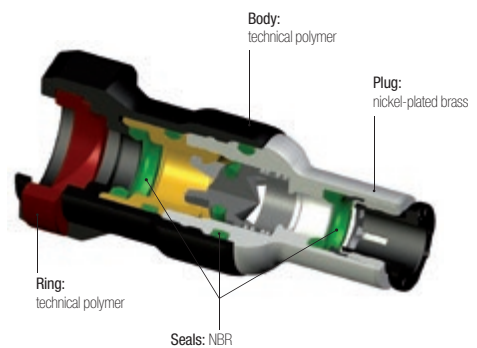

**Silicone-free**

## Operation

### Circuit Closed

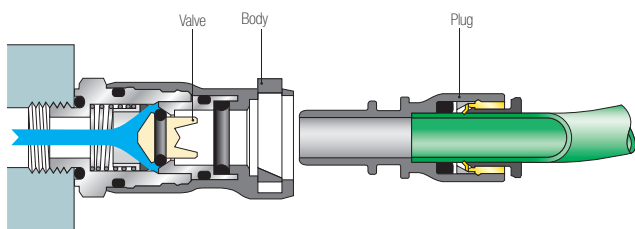

### Circuit Open

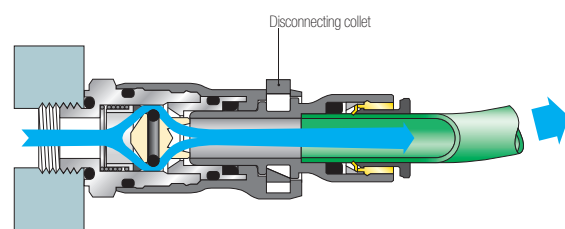

### Flow Characteristics - Pressure Drop

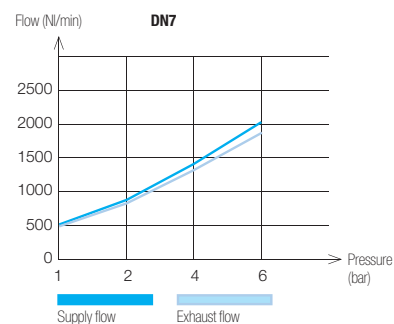
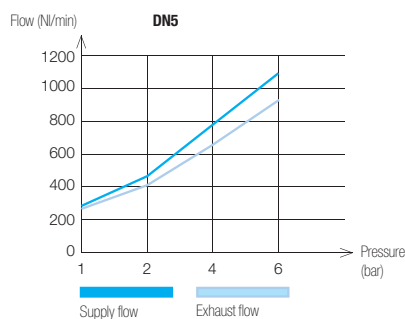

# Snap Fittings

## 7926 Body with Push-In Connection



Technical polymer, nickel-plated brass, NBR

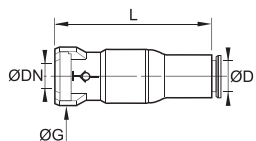

ØD	DN		G	L	Kg
6	5	<a href="#">7926 05 06</a>	18.5	44	0.020
8	5	<a href="#">7926 05 08</a>	18.5	49	0.024
10	7.3	<a href="#">7926 07 10</a>	22	58.5	0.044

## 7921 Body with Male BSPP Thread



Technical polymer, nickel-plated brass, NBR

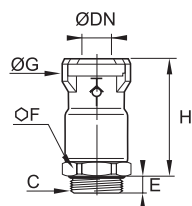

C	DN		E	F	G	H	Kg
G1/8	5	<a href="#">7921 05 10</a>	5.5	16	18.5	31.5	0.022
G1/4	5	<a href="#">7921 05 13</a>	5.5	16	18.5	31.5	0.023
G1/4	7.3	<a href="#">7921 07 13</a>	5.5	20	22	37.5	0.039
G3/8	7.3	<a href="#">7921 07 17</a>	5.5	20	22	37.5	0.041

## 7960 Straight Probe, Push-In Connection



Technical polymer, NBR

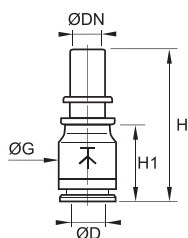

ØD	DN		G	H	H1	Kg
6	5	<a href="#">7960 05 06</a>	13.5	36.5	17.5	0.007
8	5	<a href="#">7960 05 08</a>	13.5	37	18	0.003
10	7.3	<a href="#">7960 07 10</a>	16	41	20.5	0.004

## 7961 Straight Probe, Male BSPP Thread



Technical polymer, nickel-plated brass, NBR

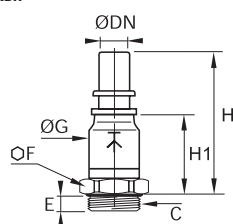

C	DN		E	F	G	H	H1	Kg
G1/8	5	<a href="#">7961 05 10</a>	5.5	13	13.5	46	27	0.017
G1/4	5	<a href="#">7961 05 13</a>	5.5	16	13.5	46	27	0.019
G1/4	7.3	<a href="#">7961 07 13</a>	5.5	16	16	51.5	31	0.026
G3/8	7.3	<a href="#">7961 07 17</a>	5.5	20	16	51.5	31	0.034

# Manually-Operated Valves

Manually-operated valves offer a **reliable** and **durable** system for opening and closing the circuit when the system has to be **switched frequently**. They provide a significant reduction in the time needed to work on pneumatic circuits.

## Product Advantages

### Manual Switch-Operated Valves

Downstream control supply provided by simply moving the lever  
 2 models available to provide the best solution for the system:

- 3/2: opening, closing, venting
- 2/2: opening, closing

Compact and ergonomic (can be positioned through 360°)  
 Push-in connections

### Valves with Sliding Sleeve

Uni-directional use ensures the downstream circuit is vented  
 Operated in the plane of the tube  
 Lightweight due to the use of aluminium  
 Ideal for complex installations in a restricted space  
 Immediate identification of the venting system by the colour (red)



Applications

- Robotics
- Conveyors
- Textile
- Plastics Engineering
- Printing
- Pneumatics
- Packaging

## Technical Characteristics

<b>Compatible Fluids</b>	Compressed air
<b>Working Pressure</b>	0 to 10 bar Model 0669: 0 to 16 bar
<b>Working Temperature</b>	-10°C to +80°C Model 0669: -5°C to +70°C

### Component Materials

Seals: NBR

Bolt:  
 Manual switch-operated valve: nickel-plated brass with seal  
 Sleeve valve: nickel-plated brass

Body:  
 Manual switch-operated valve: technical polymer  
 Sleeve valve: nickel-plated brass

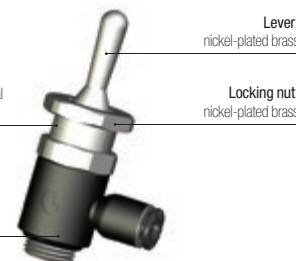

### Silicone-free

### Regulations

DI: 2002/95/EC (RoHS)  
 RG: 1907/2006 (REACH)  
 DI: 97/23/EC (PED)

## Operation

### Switch-Operated Valves



Open

Closed

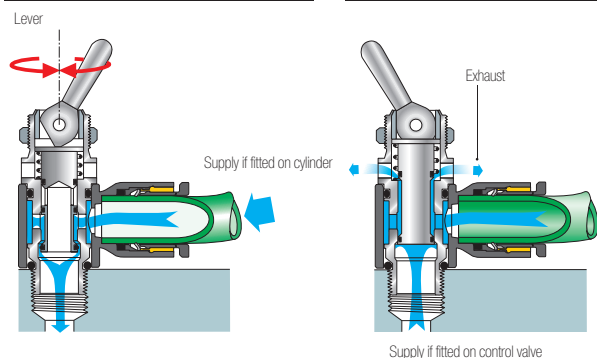

### Sleeve Valves

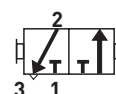

Open: downstream supply

Closed: downstream exhaust

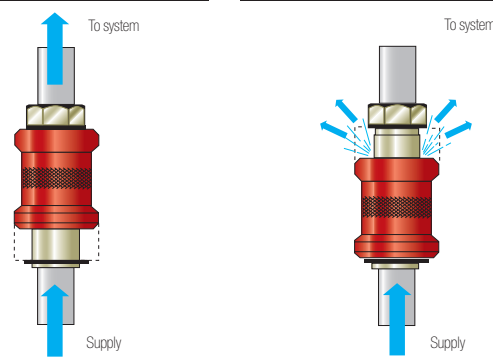

# Manually-Operated Valves

## 7800

### 3/2 Manual Switch-Operated Valve, Supply, Male BSPP and Metric Thread



Technical polymer, nickel-plated brass, NBR

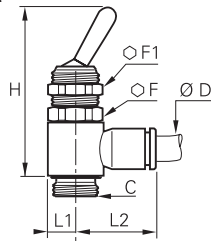

ØD	C		F	F1	H	L1	L2	Kg
4	M5x0.8	<a href="#">7800 04 19</a>	14	14	55	7	18.5	0.032
	G1/8	<a href="#">7800 04 10</a>	14	14	43	7	18.5	0.022
6	M5x0.8	<a href="#">7800 06 19</a>	14	14	55	7	18.5	0.032
	G1/8	<a href="#">7800 06 10</a>	14	14	43	7	20	0.023
8	G1/8	<a href="#">7800 08 10</a>	14	14	43	7	25	0.023
	G1/4	<a href="#">7800 08 13</a>	17	14	50.5	9	27	0.048
10	G1/8	<a href="#">7800 10 10</a>	14	14	43	7	25	0.023
	G1/4	<a href="#">7800 10 13</a>	17	14	50.5	9	29	0.048

For part numbers 7800 04 19 and 7800 06 19, adaptor sealing is effected by a flat PTFE seal and tightening torque is maximum 0.16 daN.m.

## 7801

### 3/2 Manual Switch-Operated Valve, Control, Male BSPP Thread



Technical polymer, nickel-plated brass, NBR

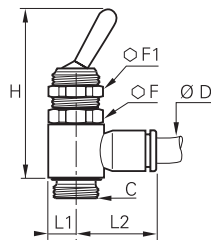

ØD	C		F	F1	H	L1	L2	Kg
4	G1/8	<a href="#">7801 04 10</a>	14	14	43	7	18.5	0.023
6	G1/8	<a href="#">7801 06 10</a>	14	14	43	7	20	0.023
	G1/4	<a href="#">7801 06 13</a>	17	14	50.5	9	22	0.048
8	G1/8	<a href="#">7801 08 10</a>	14	14	43	7	25	0.026
	G1/4	<a href="#">7801 08 13</a>	17	14	50.5	9	27	0.049
10	G1/4	<a href="#">7801 10 13</a>	17	14	50.5	9	29	0.051

## 7802

### 2/2 Manual Switch-Operated Valve, Male BSPP Thread



Technical polymer, nickel-plated brass, NBR

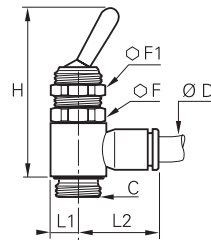

ØD	C		F	F1	H	L1	L2	Kg
4	G1/8	<a href="#">7802 04 10</a>	14	14	43	7	18.5	0.023
	G1/8	<a href="#">7802 06 10</a>	14	14	43	7	20	0.023
6	G1/4	<a href="#">7802 06 13</a>	17	14	50.5	9	22	0.051
	G1/8	<a href="#">7802 08 10</a>	14	14	43	7	25	0.024
8	G1/4	<a href="#">7802 08 13</a>	17	14	50.5	9	27	0.052
	G1/4	<a href="#">7802 10 13</a>	17	14	50.5	9	29	0.052

## 0669

### 3/2 Sleeve Valve, Female BSPP and Metric Thread



Nickel-plated brass, NBR

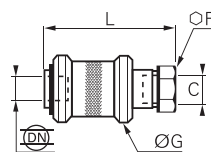

C	DN		F	G	L	Kg
M5x0.8	2.5	<a href="#">0669 02 19</a>	10	14	30.5	0.012
G1/8	4	<a href="#">0669 04 10</a>	14	25	48	0.050
G1/4	7	<a href="#">0669 07 13</a>	19	30	58	0.095
G3/8	10	<a href="#">0669 10 17</a>	22	35	68	0.154
G1/2	14	<a href="#">0669 14 21</a>	27	40	75	0.209
G3/4	19	<a href="#">0669 19 27</a>	32	50	83	0.323

# Metal Quick Exhaust Valves

This range of metal quick exhaust valves is offered in nickel-plated brass, aluminium and stainless steel. These valves, which are suitable for **any environment**, increase the **return speed** of the cylinder rod by allowing the exhaust to pass directly to atmosphere.

## Product Advantages

### Time-Saving & Compact

Reduction in cycle times: return speed improved  
 Dimensions optimised for space reduction  
 Exhaust silencer incorporated on some models  
 Excellent exhaust capacity  
 Robust

### Nickel-Plated Brass or Stainless Steel

Ideal for applications in restrictive environments  
 Orientation as required  
 Many installation options and choice of silencer  
 Designed without retention areas to optimise frequent cleaning operations (stainless steel)

### Aluminium

Protection of individuals through low noise emissions  
 Lightweight and robust  
 Silencer integrated for greater compactness



**Applications**  
 Robotics  
 Conveyors  
 Textile  
 Plastics Engineering  
 Printing  
 Pneumatics  
 Packaging

## Technical Characteristics

<b>Compatible Fluids</b>	Compressed air
<b>Working Pressure</b>	<b>7970:</b> 0.7 to 10 bar <b>7971 and 7899:</b> 2 to 10 bar
<b>Working Temperature</b>	<b>7970:</b> -20°C to +70°C <b>7971:</b> -10°C to +70°C <b>7899:</b> Threads G1/8 and G1/4: -10°C to +120°C Threads G3/8 to G1: -20°C to +180°C

### Component Materials

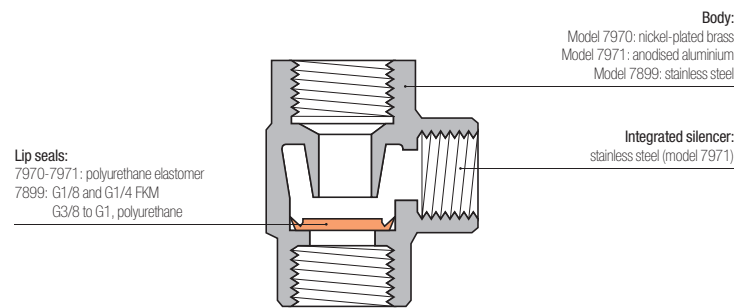

Silicone-free

### Regulations

DI: 2002/95/EC (RoHS)  
 RG: 1907/2006 (REACH)  
 DI: 97/23/EC (PED)

## Operation

### Mounted on Cylinder

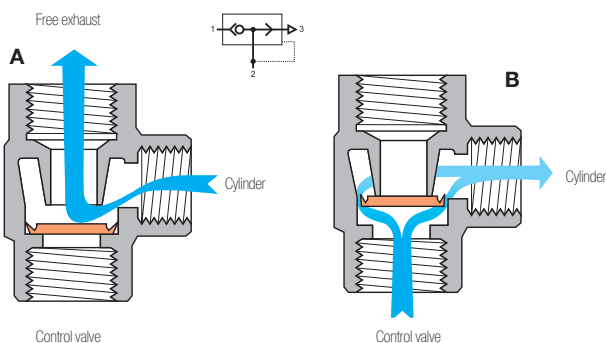

### Installation Diagram

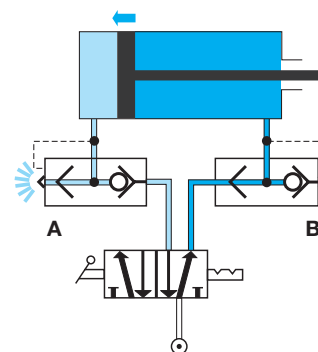

# Metal Quick Exhaust Valves

**7970**

Elbow Quick Exhaust Valve, Female BSPP and Metric Thread



Nickel-plated brass

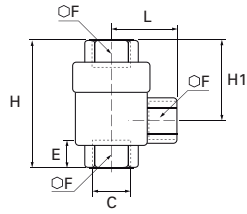

C		E	F	H	H1	L	Kg
M5x0.8	<a href="#">7970 19 19</a>	5	10	24.8	15.6	4	0.029
G1/8	<a href="#">7970 10 10</a>	7.5	14	42	28	8	0.084
G1/4	<a href="#">7970 13 13</a>	11	19	53	34.5	11	0.148
G3/8	<a href="#">7970 17 17</a>	12	21	58	36	12	0.153
G1/2	<a href="#">7970 21 21</a>	14	26	71	44	14	0.316
G3/4	<a href="#">7970 27 27</a>	16	32	86	52	18	0.449
G1	<a href="#">7970 34 34</a>	19	38	94	56	19	0.531

Noise level:

7971 10 10: 70 dBa

7971 13 13: 70 dBa

7971 17 17: 72 dBa

7971 21 21: 88 dBa

**7971**

Elbow Quick Exhaust Valve, Male BSPT/Female BSPP Thread



Treated aluminium

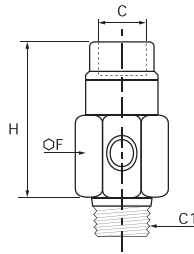

C	C1		F	H	Kg
G1/8	R1/8	<a href="#">7971 10 10</a>	18	51	0.013
G1/4	R1/4	<a href="#">7971 13 13</a>	18	49	0.018
G3/8	R3/8	<a href="#">7971 17 17</a>	27	56	0.048
G1/2	R1/2	<a href="#">7971 21 21</a>	34	70	0.086

**7899**

Quick Exhaust Valve, Female BSPP Thread



Stainless steel 316L

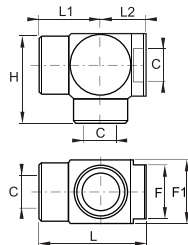

C	DN		F	F1	H	L	L1	L2	Kg
G1/8	7	<a href="#">7899 00 10</a>	17	22	31.5	37.5	21	16.5	0.097
G1/4	7	<a href="#">7899 00 13</a>	17	22	31.5	37.5	21	16.5	0.084
G3/8	9	<a href="#">7899 00 17</a>	22	26	37	44.5	25.5	19	0.140
G1/2	12	<a href="#">7899 00 21</a>	27	32	45	54	31	23	0.236
G3/4	18	<a href="#">7899 00 27</a>	38	46	65	79	44	35	0.801
G1	18	<a href="#">7899 00 34</a>	38	46	65	79	44	35	0.674

To complement our exhaust valves 7970 and 7899, you will find a full range of silencers on the following pages.

# Silencers

Silencers are designed for installation on exhaust circuits **to reduce the noise levels** of equipment while operating, thus improving user comfort.

## Product Advantages

- Variety of Applications**
- 2 versions incorporating flow control regulation
  - Extremely compact models available
  - Polyethylene: excellent balance between exhaust flow rate and noise reduction
  - Sintered bronze: robust and economic
  - 316L stainless steel: increased chemical resistance and mechanical strength



Robotics  
Textile  
Semi-Conductors  
Packaging  
Pneumatics

Applications

## Technical Characteristics

<b>Compatible Fluids</b>	Compressed air
<b>Working Pressure</b>	Polyethylene: 0 to 10 bar Sintered bronze: 0 to 12 bar 316L stainless steel: 0 to 12 bar
<b>Working Temperature</b>	Polyethylene: -10°C to +80°C Sintered bronze: -20°C to +150°C 316L stainless steel: -20°C to +180°C

### Component Materials

**Body:**  
brass (0670-0673-0675-0671-0677-0672)  
polymer (0674-0676)  
stainless steel (0682-0683)

**Silencer:**  
sintered bronze (0670-0673-0675-0671-0677-0672)  
polymer (0674-0676)  
316L stainless steel (0682-0683)

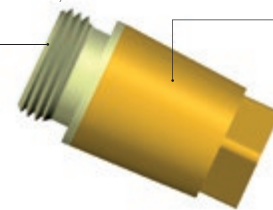

**Silicone-free**

### Regulations

- DI: 2002/95/EC (RoHS)
- RG: 1907/2006 (REACH)
- DI: 97/23/EC (PED)
- DI: 2003/10/EC (Noise Directive)
- Requirement to use ear protection if exposure > 8 hours (85 dBA)
- RG: 1910.95(b) (OSHA)
- Requirement to use ear protection if exposure > 8 hours (90 dBA)

### Flow and Noise Levels for Silencers 0672 and 0676

**0672**

	Number of Turns						Noise Level in dBA at 6 bar and 350 NI/min
	0	1	2	3	4	5	
0672 00 10	0	200	600	740	-	-	81
0672 00 13	0	300	650	1280	-	-	82
0672 00 17	0	450	950	1300	1500	-	83
0672 00 21	0	830	1430	1800	2100	2220	83

**0676**

	Number of Turns										Noise Level in dBA at 6 bar and 350 NI/min
	0	1	2	3	4	5	6	7	8	9	
0676 00 10	0	30	90	210	335	370	390	390	395	395	82
0676 00 13	0	22	25	50	340	750	940	980	1000	1025	84
0676 00 19	0	22	69	97	125	143	-	-	-	-	81
0676 00 17	0	518	1147	1716	2153	2571	2823	2930	-	-	85
0676 00 21		814	1849	2880	4087	5044	5236	-	-	-	86

# Silencers

## 0674 Polymer Silencer, Male BSPP and Metric Thread

Technical polymer

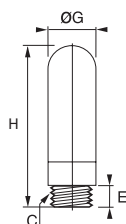

C		E	G	H	Kg
M5x0.8	<a href="#">0674 00 19</a>	4	6.5	23	0.003
G1/8	<a href="#">0674 00 10</a>	6	12.5	34	0.002
G1/4	<a href="#">0674 00 13</a>	7	15.5	42.5	0.003
G3/8	<a href="#">0674 00 17</a>	11.5	18.5	67.5	0.007
G1/2	<a href="#">0674 00 21</a>	11	23.5	78	0.010
G3/4	<a href="#">0674 00 27</a>	15.5	38.5	131	0.035
G1	<a href="#">0674 00 34</a>	19.5	49	160	0.056

## 0676 Flow Control Polymer Silencer, Male BSPP and Metric Thread

Technical polymer

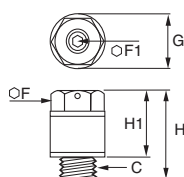

C		F	F1	G	H	H1	Kg
M5x0.8	<a href="#">0676 00 19</a>	8	1.5	9.2	16	11	0.008
G1/8	<a href="#">0676 00 10</a>	13	2.5	15	20.5	14.5	0.003
G1/4	<a href="#">0676 00 13</a>	15	4	18	29	22	0.006
G3/8	<a href="#">0676 00 17</a>	20	6	24	38	30	0.018
G1/2	<a href="#">0676 00 21</a>	25	8	30	50	40	0.045

## 0670 Threaded Silencer, Male BSPP Thread

Sintered bronze, brass

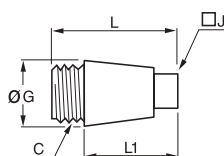

C		G	J	L	L1	Kg
G1/8	<a href="#">0670 00 10</a>	12	7	22	17	0.007
G1/4	<a href="#">0670 00 13</a>	15	9	27	21	0.015
G3/8	<a href="#">0670 00 17</a>	19	11	35	28	0.028
G1/2	<a href="#">0670 00 21</a>	23	13	43	34	0.049
G3/4	<a href="#">0670 00 27</a>	30	17	55	53.5	0.087
G1	<a href="#">0670 00 34</a>	37	21	65	53	0.148

## 0673 Compact Silencer, Male BSPP and Metric Thread

Sintered bronze, brass

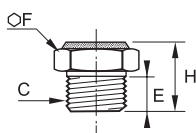

C		E	F	H	Kg
M5x0.8	<a href="#">0673 00 19</a>	4	7	8	0.001
G1/8	<a href="#">0673 00 10</a>	8	14	14	0.008
G1/4	<a href="#">0673 00 13</a>	8	17	14	0.012
G3/8	<a href="#">0673 00 17</a>	10	22	18	0.023
G1/2	<a href="#">0673 00 21</a>	12	27	21	0.041

## 0675 Threaded Silencer, Male BSPP and Metric Thread

Sintered bronze, brass

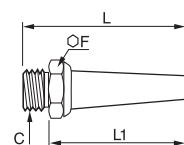

C		F	L	L1	Kg
M5x0.8	<a href="#">0675 00 19</a>	7	16	12	0.002
M7x1	<a href="#">0675 00 55</a>	11	25	19	0.005
G1/8	<a href="#">0675 00 10</a>	14	42	34	0.014
G1/4	<a href="#">0675 00 13</a>	17	52	44	0.023
G3/8	<a href="#">0675 00 17</a>	22	54	44	0.038
G1/2	<a href="#">0675 00 21</a>	27	65	53	0.073



# Silencers

## 0671 Push-In Silencer

Nickel-plated brass, sintered bronze

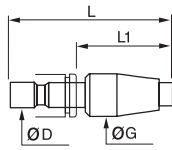

ØD		G	L	L1	Kg
4	<a href="#">0671 04 00</a>	13	43.5	28.5	0.015
6	<a href="#">0671 06 00</a>	15	50	33.5	0.024
8	<a href="#">0671 08 00</a>	15	51	34	0.025
10	<a href="#">0671 10 00</a>	19.5	67	45.5	0.052
12	<a href="#">0671 12 00</a>	20	68	45	0.052

## 0677 Miniature Silencer, Male BSPP Thread

Sintered bronze, brass

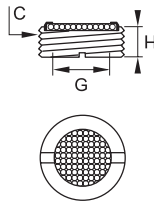

C		G	H	Kg
G1/8	<a href="#">0677 00 10</a>	6	6	0.002
G1/4	<a href="#">0677 00 13</a>	8	6	0.003
G3/8	<a href="#">0677 00 17</a>	11	7	0.005
G1/2	<a href="#">0677 00 21</a>	14	8	0.010
G3/4	<a href="#">0677 00 27</a>	19	11	0.018
G1	<a href="#">0677 00 34</a>	25	10	0.026

## 0672 Flow Control Silencer, Male BSPP Thread

Sintered bronze, nickel-plated brass

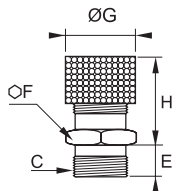

C		E	F	G	H min	H max	Kg
G1/8	<a href="#">0672 00 10</a>	8	14	14	17	21	0.017
G1/4	<a href="#">0672 00 13</a>	8	17	17	20	24	0.029
G3/8	<a href="#">0672 00 17</a>	10	22	22	20	28	0.056
G1/2	<a href="#">0672 00 21</a>	12	27	27	28	37	0.094

## 0682 Compact Silencer, Male BSPP Thread

Stainless steel 316L

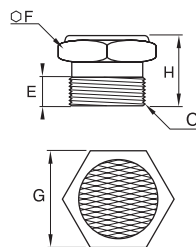

C		E	F	G	H	Kg
G1/8	<a href="#">0682 00 10</a>	8	7	14	15	0.007
G1/4	<a href="#">0682 00 13</a>	8	7	17	15	0.011
G3/8	<a href="#">0682 00 17</a>	10	8	22	18	0.019
G1/2	<a href="#">0682 00 21</a>	12	10	27	22	0.038
G3/4	<a href="#">0682 00 27</a>	15	12	32	27	0.063
G1	<a href="#">0682 00 34</a>	18	14	38	32	0.117

## 0683 Compact Silencer, Male NPT Thread

Stainless steel 316L

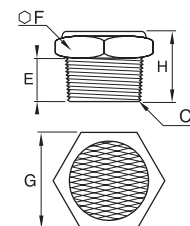

C		E	F	G	H	Kg
NPT1/8	<a href="#">0683 00 11</a>	7	7	14	14	0.008
NPT1/4	<a href="#">0683 00 14</a>	11	7	17	18	0.014
NPT3/8	<a href="#">0683 00 18</a>	11	8	22	19	0.021
NPT1/2	<a href="#">0683 00 22</a>	15	10	27	25	0.042



# Compression Fittings

**Brass Compression Fittings**

**Stainless Steel Compression Fittings**

**PL Nickel-Plated Brass Spigot Fittings**

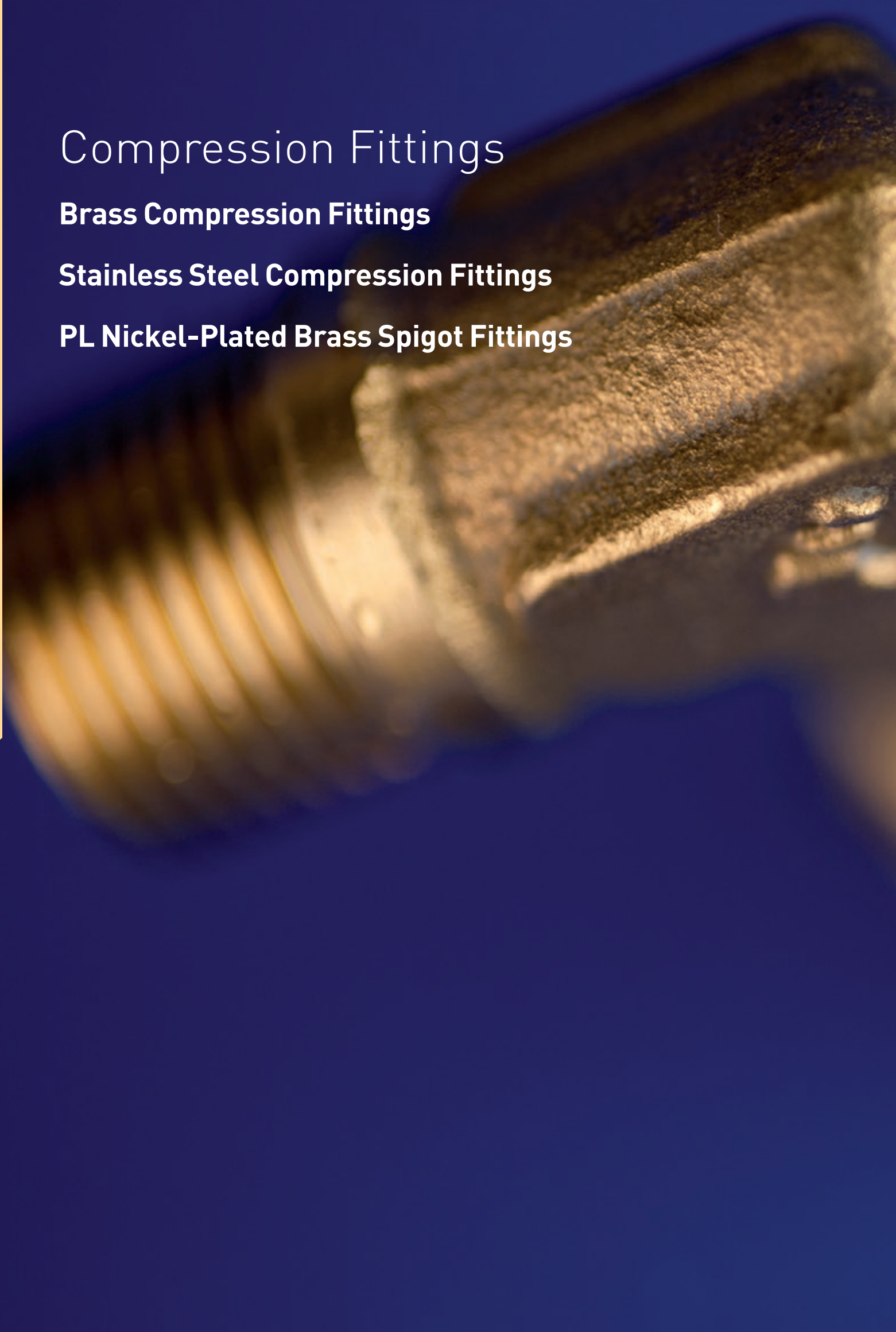



# Compression Fittings

## Brass Compression Fittings

(P. 5-5)



**Fluids:** compressed air, non-corrosive industrial fluids

**Materials:** forged or machined brass

**Pressure:** 550 bar

**Temperature:** -60°C to +250°C

**Ø metric:** 4 mm to 28 mm

## Stainless Steel Compression Fittings

(P. 5-31)



**Fluids:** compressed air, coolants, industrial and corrosive fluids

**Materials:** 316L stainless steel

**Pressure:** 400 bar

**Temperature:** -60°C to +250°C

**Ø metric:** 6 mm to 16 mm

## PL Nickel-Plated Brass Spigot Fittings

(P. 5-41)



**Fluids:** compressed air, compatible industrial fluids

**Materials:** forged or machined nickel-plated brass

**Pressure:** 18 bar

**Temperature:** -40°C to +100°C

**Ø metric:** 4 mm to 14 mm

## Compression Fitting Part Numbers

# 0105 14 27 99

### Item Type

01XX: brass  
18XX: stainless steel

### Ø

04 = 4 mm  
06 = 6 mm  
...  
20 = 20 mm  
28 = 28 mm

### Thread

10 = 1/8  
13 = 1/4  
...  
21 = 1/2  
27 = 3/4

### Suffix

39: bonded seal  
40: treated steel  
60: nut  
70: polymer nut  
99: chemical nickel

## PL Fitting Part Numbers

# F3BPL 8/10 -1/4

### Item Type

FBPL  
F3BPL  
HBPL  
WBPL  
...

### Ø

2.7/4  
4/6  
6/8  
7.5/10  
8/10  
10/12  
11/14

### Thread

BSPT:  
1/8  
1/4  
3/8  
...  
Metric:  
M10  
M12  
  
NPT: with adaptor  
BSPT and NPT

### Related Products

Parker also offers another type of brass compression fitting: **Metrulok**, with a one-piece olive/nut. Do not hesitate to contact us.



# Brass Compression Fitting Range

## Brass Fittings

### Stud Fittings

- |                                 |                                |   |                                      |                                    |                                  |                                  |                                 |
|---------------------------------|--------------------------------|---|--------------------------------------|------------------------------------|----------------------------------|----------------------------------|---------------------------------|
| <b>0105</b><br>BSPT<br>Page 5-9 | <b>0105</b><br>NPT<br>Page 5-9 | <b>0101</b><br>BSPP/Metric<br>Page 5-10 | <b>0101..39</b><br>BSPP<br>Page 5-10 | <b>0101</b><br>Metric<br>Page 5-11 | <b>0114</b><br>BSPP<br>Page 5-11 | <b>0109</b><br>BSPT<br>Page 5-12 | <b>0109</b><br>NPT<br>Page 5-12 |
|---------------------------------|--------------------------------|---|--------------------------------------|------------------------------------|----------------------------------|----------------------------------|---------------------------------|



- |                                  |                                  |                                  |                                  |                                      |                                  |                                      |
|----------------------------------|----------------------------------|----------------------------------|----------------------------------|--------------------------------------|----------------------------------|--------------------------------------|
| <b>0199</b><br>BSPP<br>Page 5-12 | <b>0108</b><br>BSPT<br>Page 5-13 | <b>0103</b><br>BSPT<br>Page 5-13 | <b>0118</b><br>BSPP<br>Page 5-14 | <b>0118..39</b><br>BSPP<br>Page 5-14 | <b>0119</b><br>BSPP<br>Page 5-15 | <b>0119..39</b><br>BSPP<br>Page 5-15 |
|----------------------------------|----------------------------------|----------------------------------|----------------------------------|--------------------------------------|----------------------------------|--------------------------------------|



### Tube-to-Tube Fittings

- |                          |                          |                          |                          |                          |                          |                          |
|--------------------------|--------------------------|--------------------------|--------------------------|--------------------------|--------------------------|--------------------------|
| <b>0106</b><br>Page 5-15 | <b>0113</b><br>Page 5-16 | <b>0116</b><br>Page 5-16 | <b>0102</b><br>Page 5-16 | <b>0104</b><br>Page 5-17 | <b>0142</b><br>Page 5-17 | <b>0107</b><br>Page 5-17 |
|--------------------------|--------------------------|--------------------------|--------------------------|--------------------------|--------------------------|--------------------------|



### Complementary Fittings

- |                          |                          |                              |                          |                          |                              |                              |                              |
|--------------------------|--------------------------|------------------------------|--------------------------|--------------------------|------------------------------|------------------------------|------------------------------|
| <b>0166</b><br>Page 5-20 | <b>0124</b><br>Page 5-21 | <b>0124..40</b><br>Page 5-21 | <b>0111</b><br>Page 5-21 | <b>0110</b><br>Page 5-22 | <b>0110..40</b><br>Page 5-22 | <b>0110..60</b><br>Page 5-22 | <b>0110..70</b><br>Page 5-22 |
|--------------------------|--------------------------|------------------------------|--------------------------|--------------------------|------------------------------|------------------------------|------------------------------|



## Self-Fastening Hose Barb Connectors

- |                          |                              |                          |
|--------------------------|------------------------------|--------------------------|
| <b>0132</b><br>Page 5-25 | <b>0133..39</b><br>Page 5-25 | <b>0134</b><br>Page 5-25 |
|--------------------------|------------------------------|--------------------------|



## Accessories

- |                          |                          |                          |                          |                          |                              |                          |                          |                              |                              |                              |
|--------------------------|--------------------------|--------------------------|--------------------------|--------------------------|------------------------------|--------------------------|--------------------------|------------------------------|------------------------------|------------------------------|
| <b>0122</b><br>Page 5-26 | <b>0165</b><br>Page 5-26 | <b>0126</b><br>Page 5-27 | <b>0125</b><br>Page 5-27 | <b>0220</b><br>Page 5-27 | <b>0220..39</b><br>Page 5-27 | <b>0120</b><br>Page 5-28 | <b>0112</b><br>Page 5-28 | <b>0128..39</b><br>Page 5-29 | <b>0151..39</b><br>Page 5-29 | <b>0168..39</b><br>Page 5-29 |
|--------------------------|--------------------------|--------------------------|--------------------------|--------------------------|------------------------------|--------------------------|--------------------------|------------------------------|------------------------------|------------------------------|



- |                          |
|--------------------------|
| <b>0127</b><br>Page 5-30 |
|--------------------------|





# Brass Compression Fittings

These **"universal"** fittings provide users with **numerous connection** options for a wide variety of tube materials without the need for tube threading or soldering. This range **guarantees** excellent long-term sealing and performance.

## Product Advantages

### Simple to Install and Use

- Suitable for pneumatic and medium pressure hydraulic applications
- Compatible with many industrial fluids
- Large product range: 22 configurations
- Excellent sealing due to the tightening of the olive onto the tube
- Metallic sealing guarantees maximum service life
- High strength brass for increased mechanical reliability

### Wide Variety of Tubing

- Connection of different types of tubing and hose: metal, polymer, steel, rubber, etc.
- Multiple tube diameters can be connected using the Parker Legris reducer assembly system
- No insert required for rigid and semi-rigid polyamide tubing below 14 mm



**Applications**

- Pneumatics
- Cooling
- Automotive Process
- Lubrication
- Fluid Transmission
- Packaging
- Industrial Machinery

## Technical Characteristics

<b>Compatible Fluids</b>	Water, machining oil, fuel, hydraulic oil, compressed air, chemical fluids, disinfectants
<b>Working Pressure</b>	Vacuum to 550 bar
<b>Working Temperature</b>	-60°C to +250°C without sealing washer, with metal tubing
<b>Tightening Torque</b>	See "Technical Characteristics" on opposite page

Working temperature: -20°C to +100°C, with sealing washer and polyamide tubing. Reliable performance is dependent upon the type of fluid conveyed, component materials and tubing being used. Guaranteed for use with a vacuum of 755 mm Hg (99% vacuum). Thread sealing must be guaranteed by user.

### Component Materials

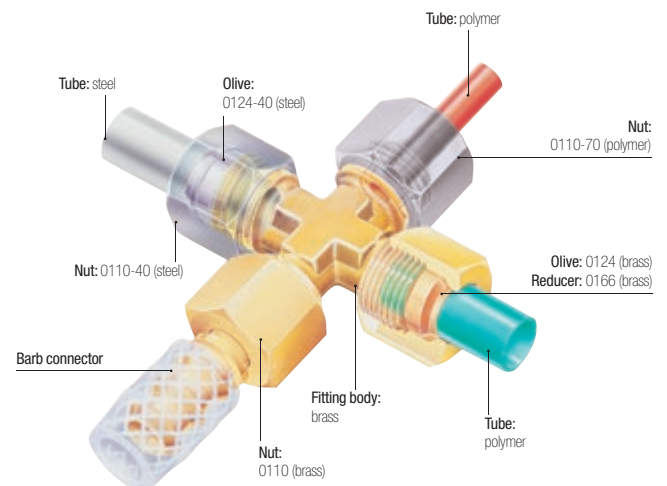

### Maximum Bore Diameters

The table below shows the recommended compatibility of tube size, BSPP male thread and maximum bore.

Tube O.D.	BSPP Thread	Max. Bore
4-5-6	G1/8	4
6-8-10	G1/4	7
10-12-14	G3/8	11
14-15-16-18	G1/2	14
18-20-22	G3/4	18
22-25-28	G1	24

### Tube Length for Assembly

Minimum length of tube (L) between 2 fittings.



ØD	L (mm)	ØD	L (mm)	ØD	L (mm)
4	26.5	12	39	20	51
5	26	14	41	22	54
6	26	15	41	25	62
8	32	16	46.5	28	62
10	39	18	49.5		

### Regulations

**CNOMO:** E07.21.115N (for robotic equipment in the automotive industry)  
**DI:** 97/23/EC (PED)  
**RG:** 1907/2006 (REACH)  
**DI:** 2002/95/EC (RoHS)  
**DI:** 94/9/EC (ATEX)

# Technical Characteristics

## Installing Compression Fittings

### Cutting the Tube



Cut the polymer or metal tube square.

### Preparing the Connection



For metal tubing, de-burr the tube prior to connection. Tube bending should be done before connection.



Slide the nut onto the tube; lubricate the threads on the body and nut along with the olive to facilitate tightening (for metal tubing as well). Fit the olive onto the end of the tube.

### Connecting the Tube



Push the tube up against the shoulder of the body of the fitting and hand tighten.

### Final Assembly



Tighten the nut using a spanner or torque wrench to enable the olive to bite on the tube, the connection being completed when the recommended tightening torque is reached (see tables below).



It is recommended to use an insert in order to prevent tube creeping (diameter > 14mm)

## Recommended Nut Tightening Torque

Tightening torque in daN.m = maximum tightening torque of a 0110 nut and 0124 olive with copper, brass or steel tube.

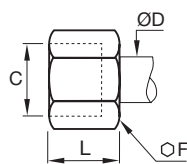

Nut 0110 and 0110..40

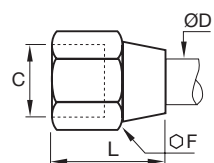

Nut 0110..60

Ø D (mm)	Ø F 0110	Ø F 0110..60	Max. daN.m Copper or Brass	Ø F 0110..40	Max. daN.m Steel
4	10	11	0.7	10	1.5
5	12	13	0.7	12	1.5
6	13	13	1.5	13	2.5
8	14	16	1.5	14	2.5
10	19	20	1.8	19	3
12	22	22	3	22	4.5
14	24	24	3.5	24	5.5
15	24	24	4	24	6
16	27	27	5	27	7
18	30	30	6	30	9
20	32	32	6	32	10
22	36	36	7	36	12
25	41	41	8	41	13
28	42		9		

## Customised Fittings

Working directly with its customers and based on its knowledge and experience, Parker Legris can design customised brass compression fittings for specific requirements using the customer's specifications.

The range of compression fittings also offers nickel chemical surface treatment in order to improve the corrosion resistance and chemical compatibility of the fittings (the model number of the fitting is then given the suffix 99).

The above recommendations are given in good faith. However, since each application is different, it is advisable to undertake tests in actual working conditions.





# Technical Characteristics

The use of Parker Legris brass compression fittings is dependant on the tube material. Tables of recommended working pressure for the different tubes are shown below.

## Recommended Tube Type

**Copper tube:** copper which has been "cold rolled", cold drawn and in straight lengths.

**Brass tube:** in cold-rolled straight lengths (same working pressure as for copper tube).

**"Coiled annealed" copper tube:** reduces working pressure by 35%; must be avoided completely if vibration is present.

**Steel tube:** "thin wall" cold drawn, seamless, bright annealed and in straight lengths. 6 mm to 16 mm O.D.: max. wall thickness 1 mm. Above 16 mm O.D.: max. wall thickness 1.5 mm

**Polyamide tube:** semi-rigid. For rigid polyamide tube, multiply the figures in this table by 1.8.

## Recommended Tube-Fitting Assembly Configurations

Assembled using Parker Legris brass olive and nut.

Assembled using Parker Legris steel olive and nut (nut type O110..40).

Assembled using Parker Legris brass olive and nut.

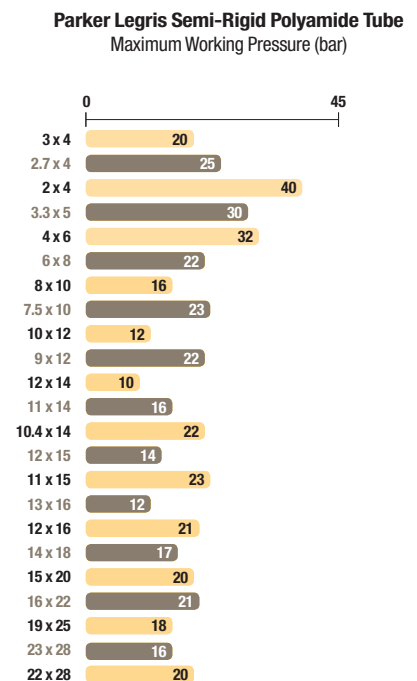
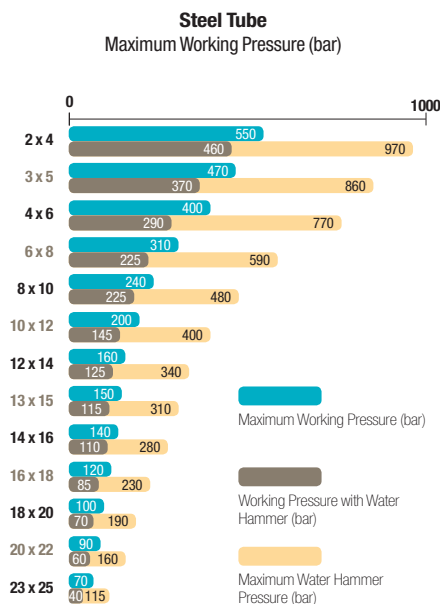
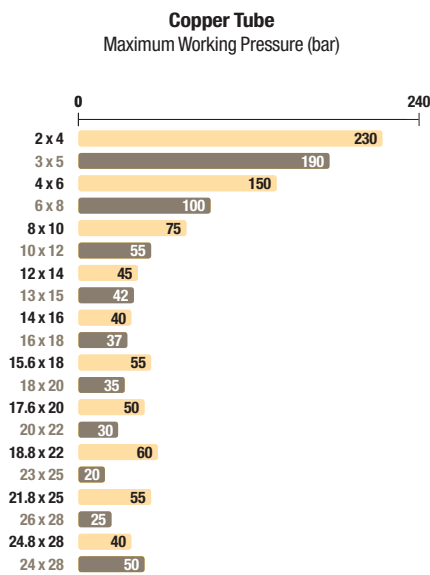

When using a plastic nut type O110..70, the maximum working pressure is 10 bar, for all diameters.

## Working Pressure Coefficients for Semi-Rigid Polyamide Tubing

Temperature °C	-40°C / -15°C	-15°C / +30°C	+30°C / +50°C	+50°C / +70°C	+70°C / +100°C
Factor	1.8	1	0.68	0.55	0.31

Parker Legris brass compression fittings are not compatible with ammonia and its derivatives.

The above recommendations are given in good faith. However, since each application is different, it is advisable to undertake tests in actual working conditions.

# Brass Compression Fittings

## 0105 Stud Fitting, Male BSPT Thread

Brass

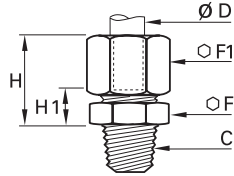

ØD	C		F	F1	H <sub>max</sub>	H1	Kg
4	R1/8	<a href="#">0105 04 10</a>	10	10	17	7	0.012
	R1/8	<a href="#">0105 05 10</a>	11	12	17.5	7.5	0.016
5	R1/4	<a href="#">0105 05 13</a>	14	12	17.5	7.5	0.023
	R1/8	<a href="#">0105 06 10</a>	11	13	18	7.5	0.017
6	R1/4	<a href="#">0105 06 13</a>	14	13	18	7.5	0.024
	R3/8	<a href="#">0105 06 17</a>	17	13	18	8.5	0.030
	R1/8	<a href="#">0105 08 10</a>	13	14	19.5	7	0.020
8	R1/4	<a href="#">0105 08 13</a>	14	14	19.5	7	0.025
	R3/8	<a href="#">0105 08 17</a>	17	14	20.5	8	0.032
	R1/8	<a href="#">0105 10 10</a>	17	19	24	9	0.042
10	R1/4	<a href="#">0105 10 13</a>	17	19	24	9	0.047
	R3/8	<a href="#">0105 10 17</a>	17	19	24	9	0.048
	R1/2	<a href="#">0105 10 21</a>	22	19	25	10	0.066
12	R1/4	<a href="#">0105 12 13</a>	19	22	24	9	0.059
	R3/8	<a href="#">0105 12 17</a>	19	22	24	9	0.060
	R1/2	<a href="#">0105 12 21</a>	22	22	25	10	0.076
14	R1/4	<a href="#">0105 14 13</a>	22	24	25	8	0.067
	R3/8	<a href="#">0105 14 17</a>	22	24	25	8	0.068
	R1/2	<a href="#">0105 14 21</a>	22	24	26	9	0.080
15	R3/4	<a href="#">0105 14 27</a>	27	24	27	10	0.107
	R3/8	<a href="#">0105 15 17</a>	22	24	25	8	0.066
	R1/2	<a href="#">0105 15 21</a>	22	24	26	9	0.077
16	R1/4	<a href="#">0105 16 13</a>	24	27	27	9.5	0.090
	R3/8	<a href="#">0105 16 17</a>	24	27	27	9.5	0.092
	R1/2	<a href="#">0105 16 21</a>	24	27	27	9.5	0.099
18	R3/4	<a href="#">0105 16 27</a>	27	27	28	10.5	0.119
	R1/2	<a href="#">0105 18 21</a>	27	30	30	10.5	0.125
	R3/4	<a href="#">0105 18 27</a>	27	30	30	10.5	0.137
20	R1/2	<a href="#">0105 20 21</a>	30	32	32	11	0.146
	R3/4	<a href="#">0105 20 27</a>	30	32	32	11	0.157
	R1/2	<a href="#">0105 22 21</a>	32	36	33	11	0.188
22	R3/4	<a href="#">0105 22 27</a>	32	36	33	11	0.197
	R1	<a href="#">0105 22 34</a>	36	36	33	11	0.225
	R3/4	<a href="#">0105 25 27</a>	36	41	36	11	0.263
25	R1	<a href="#">0105 25 34</a>	36	41	36	11	0.277
	R3/4	<a href="#">0105 28 27</a>	41	42	36	11	0.273
28	R1	<a href="#">0105 28 34</a>	41	42	36	11	0.284

Metric taper threads or NPT threads are available by special order, subject to minimum quantities.

## 0105 Stud Fitting, Male NPT Thread

Brass

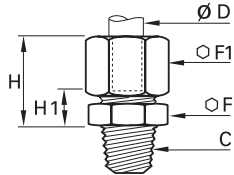

ØD	C		F	F1	H <sub>max</sub>	H1	Kg
6	NPT1/8	<a href="#">0105 06 11</a>	11	13	18	7.5	0.018
	NPT1/4	<a href="#">0105 06 14</a>	14	13	18	7.5	0.027
8	NPT1/8	<a href="#">0105 08 11</a>	13	14	21	7	0.021
	NPT1/4	<a href="#">0105 08 14</a>	14	14	18.5	7	0.026
10	NPT1/4	<a href="#">0105 10 14</a>	17	19	24	9	0.047
	NPT3/8	<a href="#">0105 10 18</a>	17	19	24	9	0.047
	NPT1/2	<a href="#">0105 10 22</a>	22	19	25	10	0.066

### Related Products

Parker also offers another type of brass compression fitting: **Metrolok**, with a one-piece olive/nut.

Do not hesitate to contact us.



# Brass Compression Fittings

## 0101 Stud Fitting with Captive Sealing Washer, Male BSPP and Metric Thread

Brass, technical polymer

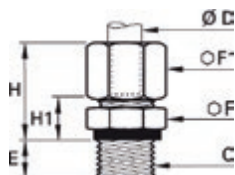

ØD	C		E	F	F1	H <sub>max</sub>	H1	Kg
4	M5x0.8	<a href="#">0101 04 19</a>	5	10	10	16.5	8	0.011
	G1/8	<a href="#">0101 04 10</a>	6.5	13	10	16.5	8	0.016
5	G1/8	<a href="#">0101 05 10</a>	6.5	13	12	17.5	8.5	0.018
	G1/8	<a href="#">0101 06 10</a>	6.5	13	13	18	8.5	0.020
6	G1/4	<a href="#">0101 06 13</a>	8	17	13	18	9.5	0.030
	G1/8	<a href="#">0101 08 10</a>	6.5	13	14	19	8.5	0.021
8	G1/4	<a href="#">0101 08 13</a>	8	17	14	19.5	9	0.031
	G3/8	<a href="#">0101 08 17</a>	11	22	14	20	10.5	0.044
10	G1/4	<a href="#">0101 10 13</a>	8	17	19	24	11	0.048
	G3/8	<a href="#">0101 10 17</a>	11	22	19	24	11.5	0.061
12	G1/4	<a href="#">0101 12 13</a>	8	19	22	24	11	0.062
	G3/8	<a href="#">0101 12 17</a>	11	22	22	24	11.5	0.070
14	G1/2	<a href="#">0101 12 21</a>	12	27	22	24	12	0.089
	G3/8	<a href="#">0101 14 17</a>	11	22	24	25	10.5	0.074
15	G1/2	<a href="#">0101 14 21</a>	12	27	24	25	11	0.093
	G3/8	<a href="#">0101 15 17</a>	11	22	24	25	10.5	0.071
16	G1/2	<a href="#">0101 15 21</a>	12	27	24	25	11	0.094
	G3/8	<a href="#">0101 16 17</a>	11	22	27	27	12	0.091
18	G1/2	<a href="#">0101 16 21</a>	12	27	27	27	12.5	0.109
	G3/4	<a href="#">0101 18 21</a>	12	27	30	29.5	12.5	0.128
20	G3/4	<a href="#">0101 18 27</a>	13	32	30	29.5	13	0.152
	G3/4	<a href="#">0101 20 27</a>	13	32	32	31	13	0.164
22	G3/4	<a href="#">0101 22 27</a>	13	32	36	32	13	0.194
	G1	<a href="#">0101 22 34</a>	15	41	36	31	13.5	0.259
25	G3/4	<a href="#">0101 25 27</a>	13	36	41	35.5	13	0.260
	G1	<a href="#">0101 25 34</a>	15	41	41	35.5	13	0.306
28	G1	<a href="#">0101 28 34</a>	15	41	42	35.5	13.5	0.299

With pre-assembled polyamide washer  
Sealing washers 0602 can be found in chapter 9.

## 0101..39 Stud Fitting, with Bi-Material Seal, Male BSPP Thread

Brass, zinc-plated steel with NBR seal

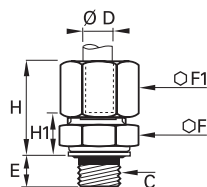

ØD	C		E	F	F1	H <sub>max</sub>	H1	Kg
4	G1/8	<a href="#">0101 04 10 39</a>	5.5	13	10	17.5	9	0.016
5	G1/8	<a href="#">0101 05 10 39</a>	5.5	13	12	18.5	9.5	0.019
	G1/8	<a href="#">0101 06 10 39</a>	5.5	13	13	19	9.5	0.020
6	G1/4	<a href="#">0101 06 13 39</a>	7	17	13	19	10.5	0.030
	G1/8	<a href="#">0101 08 10 39</a>	5.5	13	14	20	9.5	0.022
8	G1/4	<a href="#">0101 08 13 39</a>	7	17	14	20.5	10	0.031
	G3/8	<a href="#">0101 08 17 39</a>	9.5	22	14	21.5	12	0.045
10	G1/4	<a href="#">0101 10 13 39</a>	7	17	19	25	12	0.048
	G3/8	<a href="#">0101 10 17 39</a>	9.5	22	19	25.5	13	0.061
12	G1/4	<a href="#">0101 12 13 39</a>	7	19	22	25	12	0.062
	G3/8	<a href="#">0101 12 17 39</a>	9.5	22	22	25	13	0.070
14	G1/2	<a href="#">0101 12 21 39</a>	10.5	27	22	25	13.5	0.090
	G3/8	<a href="#">0101 14 17 39</a>	9.5	22	24	26.5	12	0.076
15	G1/2	<a href="#">0101 14 21 39</a>	10.5	27	24	26.5	12.5	0.094
	G3/8	<a href="#">0101 15 17 39</a>	9.5	22	24	26.5	12	0.071
16	G1/2	<a href="#">0101 15 21 39</a>	10.5	27	24	26.5	12.5	0.094
	G3/8	<a href="#">0101 16 17 39</a>	9.5	22	27	28.5	13.5	0.092
18	G1/2	<a href="#">0101 16 21 39</a>	10.5	27	27	28.5	14	0.109
	G1/2	<a href="#">0101 18 21 39</a>	10.5	27	30	31	14	0.129
20	G3/4	<a href="#">0101 18 27 39</a>	11.5	32	30	31	14.5	0.154
	G3/4	<a href="#">0101 20 27 39</a>	11.5	32	32	32.5	14.5	0.167
22	G3/4	<a href="#">0101 22 27 39</a>	11.5	32	36	32.5	14.5	0.197
	G1	<a href="#">0101 22 34 39</a>	13	41	36	33	15.5	0.259
25	G1	<a href="#">0101 25 34 39</a>	13	41	41	37.5	15.5	0.309
28	G1	<a href="#">0101 28 34 39</a>	13	41	42	37.5	15.5	0.300

Thread with bi-material seal  
Bi-material sealing washers, part number 0139, can be found in Chapter 9

# Brass Compression Fittings

## 0101 Stud Fitting, Male Metric Thread

Brass

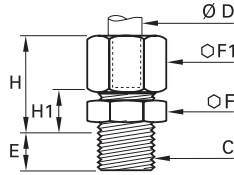

ØD	C		E	F	F1	H <sub>max</sub>	H1	Kg
4	M7x1	<a href="#">0101 04 55</a>	6.5	10	10	16.5	7.5	0.012
	M8x1	<a href="#">0101 04 56</a>	6.5	11	10	16.5	7.5	0.013
5	M8x1	<a href="#">0101 05 56</a>	6.5	11	12	17.5	8	0.015
	M10x1	<a href="#">0101 05 60</a>	6.5	14	12	17.5	8.5	0.020
6	M10x1	<a href="#">0101 06 60</a>	6.5	14	13	18	8.5	0.021
	M10x1.5	<a href="#">0101 06 62</a>	6.5	14	13	18	8.5	0.021
8	M12x1	<a href="#">0101 08 65</a>	8	17	14	19.5	9	0.029
	M12x1.25	<a href="#">0101 08 66</a>	8	17	14	19.5	9	0.029
	M13x1.25	<a href="#">0101 08 68</a>	8	17	14	19.5	9	0.030
10	M14x1.25	<a href="#">0101 10 70</a>	8	17	19	24	11	0.048
	M14x1.5	<a href="#">0101 10 71</a>	8	17	19	24	11	0.047
	M16x1.25	<a href="#">0101 10 74</a>	9	19	19	24	11	0.051
12	M16x1.5	<a href="#">0101 10 75</a>	9	19	19	24	11	0.051
	M18x1.5	<a href="#">0101 10 78</a>	9	22	19	24	11.5	0.060
	M16x1.25	<a href="#">0101 12 74</a>	9	19	22	24	11	0.061
14	M16x1.5	<a href="#">0101 12 75</a>	9	19	22	24	11	0.061
	M18x1.5	<a href="#">0101 12 78</a>	9	22	22	24	11.5	0.071
15	M18x1.5	<a href="#">0101 14 78</a>	9	22	24	25	10.5	0.071
	M20x1.5	<a href="#">0101 14 80</a>	10	24	24	25	11	0.084
16	M18x1.5	<a href="#">0101 15 78</a>	9	22	24	25	10.5	0.071
	M20x1.5	<a href="#">0101 16 80</a>	10	24	27	27	12.5	0.101
18	M22x1.5	<a href="#">0101 16 82</a>	10	27	27	27	12.5	0.110
	M22x1.5	<a href="#">0101 18 82</a>	10	27	30	29.5	12.5	0.129
	M24x1.5	<a href="#">0101 18 83</a>	11	30	30	29.5	13	0.142

## 0114 Stud Fitting, Female BSPP Thread

Brass

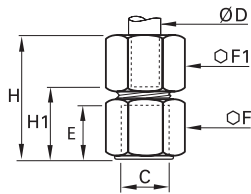

ØD	C		E	F	F1	H <sub>max</sub>	H1	Kg
4	G1/8	<a href="#">0114 04 10</a>	9.5	14	10	26	16.5	0.020
	G1/4	<a href="#">0114 04 13</a>	13.5	17	10	30	20.5	0.030
5	G1/8	<a href="#">0114 05 10</a>	9.5	14	12	28	17	0.023
	G1/4	<a href="#">0114 05 13</a>	13.5	17	12	31	21	0.033
6	G1/8	<a href="#">0114 06 10</a>	9.5	14	13	28	17	0.025
	G1/4	<a href="#">0114 06 13</a>	13.5	17	13	32	21	0.034
8	G3/8	<a href="#">0114 06 17</a>	14	22	13	32	21.5	0.051
	G1/8	<a href="#">0114 08 10</a>	9.5	14	14	29	16.5	0.026
	G1/4	<a href="#">0114 08 13</a>	13.5	17	14	33	20.5	0.035
10	G3/8	<a href="#">0114 08 17</a>	14	22	14	34	21	0.052
	G1/4	<a href="#">0114 10 13</a>	13.5	17	19	37	21.5	0.052
	G3/8	<a href="#">0114 10 17</a>	14	22	19	37	22	0.068
12	G1/2	<a href="#">0114 10 21</a>	18.5	27	19	42	26.5	0.100
	G3/8	<a href="#">0114 12 13</a>	13.5	19	22	36	20.5	0.068
	G3/8	<a href="#">0114 12 17</a>	14	22	22	37	22	0.078
14	G1/2	<a href="#">0114 12 21</a>	18.5	27	22	42	26.5	0.109
	G1/4	<a href="#">0114 14 13</a>	13.5	22	24	36	18.5	0.085
	G3/8	<a href="#">0114 14 17</a>	14	22	24	38	21	0.048
15	G1/2	<a href="#">0114 14 21</a>	18.5	27	24	43	25.5	0.112
	G3/8	<a href="#">0114 15 17</a>	14	22	24	38	21	0.078
	G1/2	<a href="#">0114 15 21</a>	18.5	27	24	43	25.5	0.109
16	G1/4	<a href="#">0114 16 13</a>	13.5	24	27	36	18	0.107
	G3/8	<a href="#">0114 16 17</a>	14	24	27	38	20.5	0.106
	G1/2	<a href="#">0114 16 21</a>	18.5	27	27	44	26	0.128
18	G3/8	<a href="#">0114 18 17</a>	14	27	30	39	19.5	0.140
	G1/2	<a href="#">0114 18 21</a>	18.5	27	30	45	26	0.144
	G3/4	<a href="#">0114 18 27</a>	19.5	32	30	46	27	0.164
20	G3/8	<a href="#">0114 20 17</a>	14	30	32	38	18	0.161
	G1/2	<a href="#">0114 20 21</a>	18.5	30	32	44.5	24	0.171
22	G3/4	<a href="#">0114 20 27</a>	19.5	32	32	47	26.5	0.171
	G3/4	<a href="#">0114 22 27</a>	19.5	32	36	48	26.5	0.203
25	G3/4	<a href="#">0114 25 27</a>	19.5	36	41	50.5	26	0.297

Brass Compression Fittings

Compression Fittings

# Brass Compression Fittings

## 0109 Stud Elbow, Male BSPT Thread

Brass

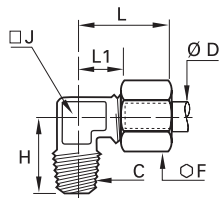

ØD	C		F	H	J	L <sub>max</sub>	L1	Kg
4	R1/8	<a href="#">0109 04 10</a>	10	17	8	19	9.5	0.016
	R1/4	<a href="#">0109 04 13</a>	10	20	10	19	11	0.024
5	R1/8	<a href="#">0109 05 10</a>	12	17.5	8	21	11	0.019
	R1/4	<a href="#">0109 05 13</a>	12	21.5	10	22	12	0.029
6	R1/8	<a href="#">0109 06 10</a>	13	18	8	22	11	0.021
	R1/4	<a href="#">0109 06 13</a>	13	21.5	10	22	12	0.030
8	R1/8	<a href="#">0109 08 10</a>	14	18.5	10	28	15	0.028
	R1/4	<a href="#">0109 08 13</a>	14	22	10	28	15	0.034
	R3/8	<a href="#">0109 08 17</a>	14	24	12	28	15	0.043
10	R1/4	<a href="#">0109 10 13</a>	19	25	12	30	14.5	0.053
	R3/8	<a href="#">0109 10 17</a>	19	25.5	12	30	14.5	0.059
	R1/2	<a href="#">0109 10 21</a>	19	32	19	36	21	0.108
12	R1/4	<a href="#">0109 12 13</a>	22	26	15	30	15	0.074
	R3/8	<a href="#">0109 12 17</a>	22	27	15	30	15	0.077
	R1/2	<a href="#">0109 12 21</a>	22	32	19	36	21	0.114
14	R3/8	<a href="#">0109 14 17</a>	24	30	19	35	18	0.105
	R1/2	<a href="#">0109 14 21</a>	24	32	19	35	18	0.111
15	R3/8	<a href="#">0109 15 17</a>	24	30	19	35	18	0.100
	R1/2	<a href="#">0109 15 21</a>	24	32	19	35	18	0.108
	R3/8	<a href="#">0109 16 17</a>	27	30	19	39	21	0.121
16	R1/2	<a href="#">0109 16 21</a>	27	33.5	19	39	21	0.129
	R3/4	<a href="#">0109 16 27</a>	27	36.5	23	41	23	0.185
	R1/2	<a href="#">0109 18 21</a>	30	35.5	23	41	21.5	0.179
18	R3/4	<a href="#">0109 18 27</a>	30	36.5	23	41	21.5	0.198
	R1/2	<a href="#">0109 20 21</a>	32	36.5	23	42	21.5	0.183
	R3/4	<a href="#">0109 20 27</a>	32	38	23	42	21.5	0.203
22	R3/4	<a href="#">0109 22 27</a>	36	40	27	50	30	0.287
	R1	<a href="#">0109 22 34</a>	36	44	27	50	30	0.336
25	R3/4	<a href="#">0109 25 27</a>	41	43	27	54	30	0.328
	R1	<a href="#">0109 25 34</a>	41	44	27	54	30	0.368
28	R3/4	<a href="#">0109 28 27</a>	42	46	32	54	30	0.404
	R1	<a href="#">0109 28 34</a>	42	48	32	54	30	0.382

Metric taper threads or NPT threads are available by special order, subject to minimum quantities.

## 0109 Stud Elbow, Male NPT Thread

Brass

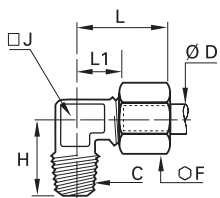

ØD	C		F	H	J	L <sub>max</sub>	L1	Kg
6	NPT1/8	<a href="#">0109 06 11</a>	13	18	8	22	11	0.021
	NPT1/4	<a href="#">0109 06 14</a>	13	21.5	10	22	12	0.030
8	NPT1/8	<a href="#">0109 08 11</a>	14	18.5	10	28	15	0.028
	NPT1/4	<a href="#">0109 08 14</a>	14	22	10	28	15	0.033
10	NPT1/4	<a href="#">0109 10 14</a>	19	25	12	30	14.5	0.053

## 0199 Stud Orientable Elbow, Male BSPP Thread

Brass, NBR

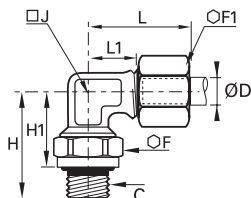

ØD	C		F	F1	H	H1	H1 <sub>max</sub>	J	L <sub>max</sub>	L1	Kg
4	G1/8	<a href="#">0199 04 10</a>	14	10	23	16	17	8	19	9.5	0.022
	G1/4	<a href="#">0199 04 13</a>	19	10	30.5	22	23.5	10	19	11	0.043
6	G1/8	<a href="#">0199 06 10</a>	14	13	23	16	17	8	22	11	0.027
	G1/4	<a href="#">0199 06 13</a>	19	13	30.5	22	23.5	10	22	12	0.046
8	G1/8	<a href="#">0199 08 10</a>	14	14	24	17	18	10	28	15	0.034
	G1/4	<a href="#">0199 08 13</a>	19	14	30.5	22	23.5	10	28	15	0.049
	G3/8	<a href="#">0199 08 17</a>	22	14	33.5	24	25.5	12	28	15	0.065
10	G1/4	<a href="#">0199 10 13</a>	19	19	31	22.5	24	12	30	14.5	0.067
	G3/8	<a href="#">0199 10 17</a>	22	19	33.5	24	25.5	12	30	14.5	0.078
	G1/2	<a href="#">0199 10 21</a>	27	19	40	29.5	31	19	37	22	0.137
14	G3/8	<a href="#">0199 14 17</a>	22	24	35.5	26	27.5	19	35	18	0.118
	G1/2	<a href="#">0199 14 21</a>	27	24	40	29.5	31	19	35	18	0.140
	G1/2	<a href="#">0199 18 21</a>	27	30	40	29	30.5	23	41	21.5	0.187
18	G3/4	<a href="#">0199 18 27</a>	32	30	43.5	32	33.5	23	41	21.5	0.222
	G3/4	<a href="#">0199 22 27</a>	32	36	45.5	34	36	32	51	31	0.385
22	G1	<a href="#">0199 22 34</a>	41	36	54	40.5	43	32	51	31	0.409
	G1	<a href="#">0199 28 34</a>	41	42	54	40.5	43	32	54	30	0.411

The body will orientate for positioning purposes.

# Brass Compression Fittings

## 0108

### Stud Branch Tee, Male BSPT Thread

Brass

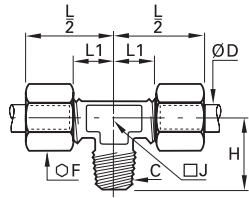

ØD	C		F	H	J	L1	L/2	Kg
4	R1/8	<a href="#">0108 04 10</a>	10	17	8	9.5	19	0.025
5	R1/8	<a href="#">0108 05 10</a>	12	17.5	8	11	21	0.031
6	R1/8	<a href="#">0108 06 10</a>	13	18	8	11	22	0.033
	R1/4	<a href="#">0108 06 13</a>	13	21.5	10	16	27	0.047
8	R1/8	<a href="#">0108 08 10</a>	14	18.5	10	15	28	0.043
	R1/4	<a href="#">0108 08 13</a>	14	22	10	15	28	0.050
10	R3/8	<a href="#">0108 08 17</a>	14	24	12	15	28	0.061
	R1/4	<a href="#">0108 10 13</a>	19	25	12	14.5	30	0.085
12	R3/8	<a href="#">0108 10 17</a>	19	25.5	12	14.5	30	0.092
	R1/4	<a href="#">0108 12 13</a>	22	26	15	15	30	0.114
14	R3/8	<a href="#">0108 12 17</a>	22	27	15	15	30	0.117
	R3/8	<a href="#">0108 14 17</a>	24	30	19	18	35	0.159
15	R1/2	<a href="#">0108 14 21</a>	24	32	19	18	35	0.166
	R3/8	<a href="#">0108 15 17</a>	24	30	19	18	35	0.147
16	R1/2	<a href="#">0108 15 21</a>	24	32	19	18	35	0.155
	R3/8	<a href="#">0108 16 17</a>	27	30	19	21	39	0.190
18	R1/2	<a href="#">0108 16 21</a>	27	33.5	19	21	39	0.203
	R1/2	<a href="#">0108 18 21</a>	30	35.5	23	21.5	41	0.270
20	R3/4	<a href="#">0108 18 27</a>	30	36.5	23	21.5	41	0.292
	R3/4	<a href="#">0108 20 27</a>	32	38	23	21.5	42	0.299
22	R3/4	<a href="#">0108 22 27</a>	36	40	27	29	50	0.431
	R1	<a href="#">0108 22 34</a>	36	44	27	29	50	0.466

Metric taper threads or NPT threads are available by special order, subject to minimum quantities.

## 0103

### Stud Run Tee, Male BSPT Thread

Brass

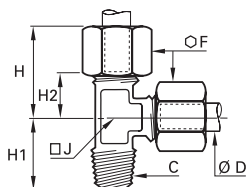

ØD	C		F	H <sub>max</sub>	H1	H2	J	Kg
4	R1/8	<a href="#">0103 04 10</a>	10	19	17	9.5	8	0.025
5	R1/8	<a href="#">0103 05 10</a>	12	21	17.5	11	8	0.030
6	R1/8	<a href="#">0103 06 10</a>	13	22	18	11	8	0.033
	R1/4	<a href="#">0103 06 13</a>	13	27	21.5	16	10	0.046
8	R1/8	<a href="#">0103 08 10</a>	14	28	18.5	15	10	0.044
	R1/4	<a href="#">0103 08 13</a>	14	28	22	15	10	0.049
10	R3/8	<a href="#">0103 08 17</a>	14	28	24	15	12	0.061
	R1/4	<a href="#">0103 10 13</a>	19	30	25	14.5	12	0.084
12	R3/8	<a href="#">0103 10 17</a>	19	30	25.5	14.5	12	0.091
	R1/4	<a href="#">0103 12 13</a>	22	30	26	15	15	0.114
14	R3/8	<a href="#">0103 12 17</a>	22	30	27	15	15	0.121
	R3/8	<a href="#">0103 14 17</a>	24	35	30	18	19	0.161
15	R1/2	<a href="#">0103 14 21</a>	24	35	32	18	19	0.171
	R3/8	<a href="#">0103 15 17</a>	24	35	30	18	19	0.148
16	R1/2	<a href="#">0103 15 21</a>	24	35	32	18	19	0.158
	R3/8	<a href="#">0103 16 17</a>	27	39	30	21	19	0.188
18	R1/2	<a href="#">0103 16 21</a>	27	39	33.5	21	19	0.202
	R1/2	<a href="#">0103 18 21</a>	30	41	35.5	21.5	23	0.269
20	R3/4	<a href="#">0103 18 27</a>	30	41	36.5	21.5	23	0.291
	R3/4	<a href="#">0103 20 27</a>	32	42	38	21.5	23	0.298
22	R3/4	<a href="#">0103 22 27</a>	36	50	40	29	27	0.435

Metric taper threads or NPT threads are available by special order, subject to minimum quantities.

### Related Products

Parker also offers another type of brass compression fitting: **Metrulok**, with a one-piece olive/nut. Do not hesitate to contact us.



# Brass Compression Fittings

## 0118 Single Banjo with Captive Sealing Washer, Male BSPP Thread

Brass, technical polymer

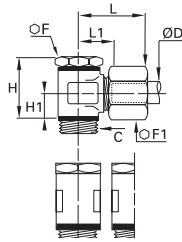

ØD	C		F	F1	H	H1	L <sub>max</sub>	L1	N	Kg
4	G1/8	<a href="#">0118 04 10</a>	14	10	24	9.5	24	14.5	17.5	0.038
	G1/8	<a href="#">0118 05 10</a>	14	12	24	9.5	25	14.5	17.5	0.041
5	G1/4	<a href="#">0118 05 13</a>	17	12	25	10	26	16	21	0.058
	G1/8	<a href="#">0118 06 10</a>	14	13	24	9.5	25	14.5	17.5	0.041
6	G1/4	<a href="#">0118 06 13</a>	17	13	25	10	26	16	21	0.056
	G1/8	<a href="#">0118 08 10</a>	14	14	24	9.5	28	15.5	17.5	0.055
8	G1/4	<a href="#">0118 08 13</a>	17	14	25	10	28	15.5	21	0.058
	G3/8	<a href="#">0118 08 17</a>	22	14	32	13	30	18	26.5	0.110
10	G1/4	<a href="#">0118 10 13</a>	17	19	31	13	34	19	23	0.117
	G3/8	<a href="#">0118 10 17</a>	22	19	32	13	34	19	26.5	0.125
12	G1/4	<a href="#">0118 12 13</a>	17	22	34	14.5	34	19	23	0.126
	G3/8	<a href="#">0118 12 17</a>	22	22	35	14.5	34	19	26.5	0.138
14	G1/4	<a href="#">0118 14 13</a>	17	24	37	16	37	20.5	28	0.154
	G3/8	<a href="#">0118 14 17</a>	22	24	38	16	37	20.5	28	0.202
15	G1/2	<a href="#">0118 14 21</a>	27	24	40	16	38	20.5	32.5	0.202
	G3/8	<a href="#">0118 15 17</a>	22	24	38	16	37	20.5	28	0.189
16	G1/2	<a href="#">0118 15 21</a>	27	24	40	16	38	20.5	32.5	0.196
	G1/2	<a href="#">0118 16 21</a>	27	27	42	16	38	21	32.5	0.219
18	G1/2	<a href="#">0118 18 21</a>	27	30	46	19.5	43	24.5	36	0.362
20	G3/4	<a href="#">0118 20 27</a>	32	32	49	20	44	24.5	39	0.406
22	G3/4	<a href="#">0118 22 27</a>	32	36	53	22	45	24.5	39	0.454

Thread with pre-assembled washer  
Sealing washers 0602 can be found in chapter 9.

## 0118..39 Single Banjo with Bi-Material Seal, Male BSPP Thread

Brass, zinc-plated steel with NBR seal

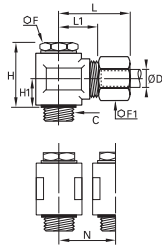

ØD	C		F	F1	H	H1	L <sub>max</sub>	L1	N	Kg
4	G1/8	<a href="#">0118 04 10 39</a>	14	10	23	9.5	24	14.5	17.5	0.039
	G1/8	<a href="#">0118 05 10 39</a>	14	12	23	9.5	25	14.5	17.5	0.041
5	G1/4	<a href="#">0118 05 13 39</a>	17	12	24	10	26	16	21	0.064
	G1/8	<a href="#">0118 06 10 39</a>	14	13	23	9.5	25	14.5	17.5	0.042
6	G1/4	<a href="#">0118 06 13 39</a>	17	13	24	10	26	16	21	0.057
	G1/8	<a href="#">0118 08 10 39</a>	14	14	23	9.5	28	15.5	17.5	0.056
8	G1/4	<a href="#">0118 08 13 39</a>	17	14	24	10	28	15.5	21	0.059
	G3/8	<a href="#">0118 08 17 39</a>	22	14	31.5	13.5	30	18	26.5	0.113
10	G1/4	<a href="#">0118 10 13 39</a>	17	19	30	13	34	19	23	0.119
	G3/8	<a href="#">0118 10 17 39</a>	22	19	31.5	13.5	34	19	26.5	0.127
12	G1/4	<a href="#">0118 12 13 39</a>	17	22	33	14.5	34	19	23	0.126
	G3/8	<a href="#">0118 12 17 39</a>	22	22	34.5	15	34	19	26.5	0.136
14	G1/4	<a href="#">0118 14 13 39</a>	17	24	36	16	37	20.5	28	0.190
	G3/8	<a href="#">0118 14 17 39</a>	22	24	37.5	16.5	37	20.5	28	0.198
15	G1/2	<a href="#">0118 14 21 39</a>	27	24	39	16.5	38	20.5	32.5	0.206
	G1/2	<a href="#">0118 15 21 39</a>	27	24	40	16.5	38	20.5	32.5	0.202
16	G1/2	<a href="#">0118 16 21 39</a>	27	27	40	16.5	38	21	32.5	0.222
	G1/2	<a href="#">0118 18 21 39</a>	27	30	47	20	43	24.5	36	0.365
20	G3/4	<a href="#">0118 20 27 39</a>	32	32	50	20.5	44	24.5	39	0.394
22	G3/4	<a href="#">0118 22 27 39</a>	32	36	54	22.5	45	24.5	39	0.462

With bi-material sealing washer  
The bi-material sealing washers, part number 0139, can be found in chapter 9.



# Brass Compression Fittings

## 0119 Double Banjo with Captive Sealing Washer, Male BSPP Thread

Brass, technical polymer

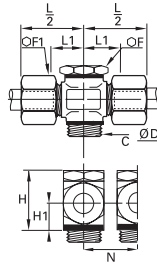

ØD	C		F	F1	H	H1	L1	L/2	N	Kg
4	G1/8	<a href="#">0119 04 10</a>	14	10	24	9.5	14.5	24	17.5	0.051
	G1/8	<a href="#">0119 06 10</a>	14	13	24	9.5	14.5	25	17.5	0.056
6	G1/4	<a href="#">0119 06 13</a>	17	13	25	10	16	26.5	21	0.073
	G1/8	<a href="#">0119 08 10</a>	14	14	24	9.5	15.5	28	17.5	0.070
8	G1/4	<a href="#">0119 08 13</a>	17	14	25	10	15.5	28	21	0.075
	G3/8	<a href="#">0119 08 17</a>	22	14	32	13	18	30.5	26.5	0.140
10	G1/4	<a href="#">0119 10 13</a>	17	19	31	13	19	34	23	0.156
	G3/8	<a href="#">0119 10 17</a>	22	19	32	13	19	34	26.5	0.173
12	G1/4	<a href="#">0119 12 13</a>	17	22	34	14.5	19	34	23	0.173
	G3/8	<a href="#">0119 12 17</a>	22	22	35	14.5	19	34	26.5	0.182
14	G1/4	<a href="#">0119 14 13</a>	17	24	37	16	20.5	37.5	28	0.246
	G3/8	<a href="#">0119 14 17</a>	22	24	38	16	20.5	37.5	28	0.245
	G1/2	<a href="#">0119 14 21</a>	27	24	40	16	20.5	38	32.5	0.219

Thread with pre-assembled washer

Sealing washers 0602 can be found in Chapter 9.

## 0119..39 Double Banjo with Bi-Material Seal, Male BSPP Thread

Brass, zinc-plated steel with NBR seal

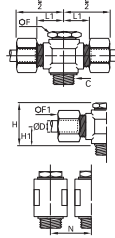

ØD	C		F	F1	H	H1	L1	L/2	N	Kg
4	G1/8	<a href="#">0119 04 10 39</a>	14	10	23	9.5	14.5	24	17.5	0.050
	G1/8	<a href="#">0119 05 10 39</a>	14	12	23	9.5	14.5	25	17.5	0.049
5	G1/4	<a href="#">0119 05 13 39</a>	17	12	24	10	126	26	21	0.072
	G1/8	<a href="#">0119 06 10 39</a>	14	13	23	9.5	14.5	25	17.5	0.057
6	G1/4	<a href="#">0119 06 13 39</a>	17	13	24	10	16	26	21	0.071
	G1/8	<a href="#">0119 08 10 39</a>	14	14	23	9.5	15.5	28	17.5	0.071
8	G1/4	<a href="#">0119 08 13 39</a>	17	14	24	10	15.5	28	21	0.075
	G3/8	<a href="#">0119 08 17 39</a>	22	14	31.5	13.5	18	30	26.5	0.137
10	G1/4	<a href="#">0119 10 13 39</a>	17	19	30	13	19	34	23	0.156
	G3/8	<a href="#">0119 10 17 39</a>	22	19	31.5	13.5	19	34	26.5	0.167
12	G1/4	<a href="#">0119 12 13 39</a>	17	22	33	14.5	19	34	23	0.180
	G1/4	<a href="#">0119 14 13 39</a>	17	24	36	16	20.5	37	28	0.248
14	G3/8	<a href="#">0119 14 17 39</a>	22	24	37.5	16.5	20.5	37	28	0.247
	G1/2	<a href="#">0119 14 21 39</a>	27	24	39	16.5	20.5	38	32.5	0.261
15	G3/8	<a href="#">0119 15 17 39</a>	22	24	37.5	16.5	20.5	37	28	0.246
	G1/2	<a href="#">0119 15 21 39</a>	27	24	40	16.5	20.5	38	32.5	0.251
18	G1/2	<a href="#">0119 18 21 39</a>	27	30	47	20	24.5	43	36	0.471
20	G3/4	<a href="#">0119 20 27 39</a>	32	32	50	20.5	24.5	44	39	0.638
22	G3/4	<a href="#">0119 22 27 39</a>	32	36	54	22.5	24.5	45	39	0.610

Thread with pre-assembled washer

Bi-material sealing washers, part number 0139, can be found in Chapter 9.

## 0106 Equal Tube-to-Tube Connector

Brass

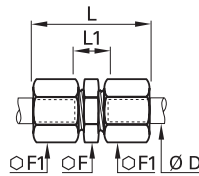

ØD		F	F1	L <sub>max</sub>	L1	Kg
4	<a href="#">0106 04 00</a>	10	10	28	10	0.017
5	<a href="#">0106 05 00</a>	11	12	31	11	0.024
6	<a href="#">0106 06 00</a>	11	13	32	11	0.026
8	<a href="#">0106 08 00</a>	13	14	36	10	0.031
10	<a href="#">0106 10 00</a>	17	19	42	13	0.070
12	<a href="#">0106 12 00</a>	19	22	42	13	0.091
14	<a href="#">0106 14 00</a>	22	24	45	11	0.103
15	<a href="#">0106 15 00</a>	22	24	45	11	0.098
16	<a href="#">0106 16 00</a>	24	27	48	13	0.142
18	<a href="#">0106 18 00</a>	27	30	53	14	0.188
20	<a href="#">0106 20 00</a>	30	32	56	14	0.215
22	<a href="#">0106 22 00</a>	32	36	60	14	0.282
25	<a href="#">0106 25 00</a>	36	41	64	14	0.401
28	<a href="#">0106 28 00</a>	41	42	64	14	0.397



# Brass Compression Fittings

## 0113 Equal Tube-to-Tube Connector with Mounting Boss

Brass

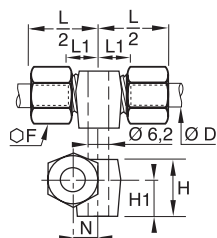

ØD		F	H	H1	L1	L/2	N	Kg
4	<a href="#">0113 04 00</a>	10	10.5	7	9.5	19	6	0.021
6	<a href="#">0113 06 00</a>	13	13	9	10	20.5	7	0.033
8	<a href="#">0113 08 00</a>	14	14.5	9.5	11	23.5	8	0.040
10	<a href="#">0113 10 00</a>	19	19.5	12.5	11	26	9	0.081
12	<a href="#">0113 12 00</a>	22	22	14	12	26.5	11	0.108
14	<a href="#">0113 14 00</a>	24	25	16	11	28	12	0.124

## 0116 Equal Bulkhead Connector

Brass

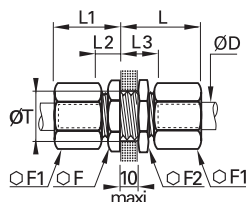

ØD		F	F1	F2	L max	L1 max	L2	L3	ØT min	Kg
4	<a href="#">0116 04 00</a>	10	10	13	27	17	7	17	8.3	0.024
5	<a href="#">0116 05 00</a>	13	12	14	28	18	7.5	17.5	10.3	0.035
6	<a href="#">0116 06 00</a>	13	13	14	28	19	7.5	17.5	10.3	0.037
8	<a href="#">0116 08 00</a>	14	14	17	29	20	7	17	12.3	0.045
10	<a href="#">0116 10 00</a>	19	19	22	33	25	9	19	16.5	0.100
12	<a href="#">0116 12 00</a>	22	22	22	33	25	9	19	18.5	0.121
14	<a href="#">0116 14 00</a>	24	24	27	35	25	8	18	20.5	0.144
15	<a href="#">0116 15 00</a>	24	24	24	35	25	8	18	20.5	0.134
16	<a href="#">0116 16 00</a>	27	27	27	36	28	9.5	19.5	22.5	0.188
18	<a href="#">0116 18 00</a>	27	30	30	40	30	10.5	20.5	24.5	0.238
20	<a href="#">0116 20 00</a>	32	30	32	41	31	11	21	27.5	0.275
22	<a href="#">0116 22 00</a>	36	36	36	42	32	11	21	30.5	0.376
25	<a href="#">0116 25 00</a>	36	41	38	46	36	11	21	33.5	0.479

## 0102 Equal Elbow

Brass

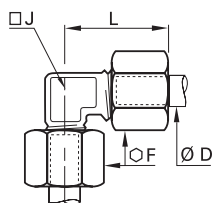

ØD		F	J	L max	Kg
4	<a href="#">0102 04 00</a>	10	5	19	0.016
5	<a href="#">0102 05 00</a>	12	8	21	0.025
6	<a href="#">0102 06 00</a>	13	8	22	0.027
8	<a href="#">0102 08 00</a>	14	10	28	0.038
10	<a href="#">0102 10 00</a>	19	12	30	0.072
12	<a href="#">0102 12 00</a>	22	15	30	0.098
14	<a href="#">0102 14 00</a>	24	19	35	0.133
15	<a href="#">0102 15 00</a>	24	19	35	0.123
16	<a href="#">0102 16 00</a>	27	19	39	0.165
18	<a href="#">0102 18 00</a>	30	23	41	0.230
20	<a href="#">0102 20 00</a>	32	23	42	0.236
22	<a href="#">0102 22 00</a>	36	27	50	0.373
25	<a href="#">0102 25 00</a>	41	27	54	0.452
28	<a href="#">0102 28 00</a>	42	32	54.5	0.474

### Related Products

Parker also offers another type of brass compression fitting:

**Metrulok**, with a one-piece olive/nut.

Do not hesitate to contact us.



# Brass Compression Fittings

## 0104 Equal Tee

Brass

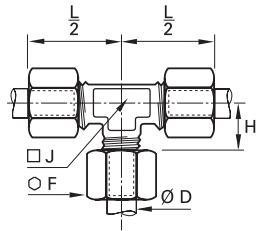

ØD		F	H	J	L/2	Kg
4	<a href="#">0104 04 00</a>	10	9.5	8	19	0.028
5	<a href="#">0104 05 00</a>	12	11	8	21	0.036
6	<a href="#">0104 06 00</a>	13	11	8	22	0.040
8	<a href="#">0104 08 00</a>	14	15	10	28	0.055
10	<a href="#">0104 10 00</a>	19	14.5	12	30	0.105
12	<a href="#">0104 12 00</a>	22	15	15	30	0.141
14	<a href="#">0104 14 00</a>	24	18	19	35	0.186
15	<a href="#">0104 15 00</a>	24	18	19	35	0.174
16	<a href="#">0104 16 00</a>	27	21	19	39	0.234
18	<a href="#">0104 18 00</a>	30	21.5	23	41	0.319
20	<a href="#">0104 20 00</a>	32	21.5	23	42	0.330
22	<a href="#">0104 22 00</a>	36	29	27	50	0.516
25	<a href="#">0104 25 00</a>	41	29	27	54	0.637
28	<a href="#">0104 28 00</a>	42	30	32	55	0.661

## 0142 Equal Y Piece with Mounting Boss

Brass

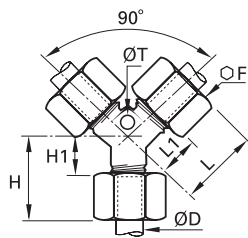

ØD		F	H <sub>max</sub>	H1	L <sub>max</sub>	L1	ØT	Kg
4	<a href="#">0142 04 00</a>	10	16.5	7	26.5	17	4.2	0.032
6	<a href="#">0142 06 00</a>	13	19.5	8.5	28	17	4.2	0.049
8	<a href="#">0142 08 00</a>	14	21	8	30	17	6.2	0.061
10	<a href="#">0142 10 00</a>	19	24.5	9	37.5	22	6.2	0.128
12	<a href="#">0142 12 00</a>	22	26	11	38	23	6.2	0.110
14	<a href="#">0142 14 00</a>	24	28	11	41.5	24.5	6.2	0.201
15	<a href="#">0142 15 00</a>	24	28	11	41.5	24.5	6.2	0.204
16	<a href="#">0142 16 00</a>	27	30	12	43	25	6.2	0.252
18	<a href="#">0142 18 00</a>	30	31.5	12	50.5	31	10.2	0.353

## 0107 Equal Cross

Brass

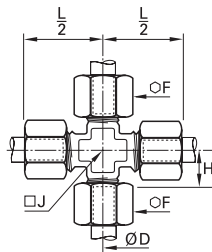

ØD		F	H	J	L/2	Kg
4	<a href="#">0107 04 00</a>	10	9.5	8	19	0.035
5	<a href="#">0107 05 00</a>	12	11	8	21	0.047
6	<a href="#">0107 06 00</a>	13	11	8	22	0.052
8	<a href="#">0107 08 00</a>	14	15	11	28	0.074
10	<a href="#">0107 10 00</a>	19	14.5	14	30	0.142
12	<a href="#">0107 12 00</a>	22	15	15	35	0.234
14	<a href="#">0107 14 00</a>	24	18	20	35	0.246
15	<a href="#">0107 15 00</a>	24	18	20	35	0.224
16	<a href="#">0107 16 00</a>	27	21	20	39	0.309
18	<a href="#">0107 18 00</a>	30	21.5	25	41	0.423
20	<a href="#">0107 20 00</a>	32	21.5	25	42	0.429
22	<a href="#">0107 22 00</a>	36	29	27	50	0.670
25	<a href="#">0107 25 00</a>	41	29	27	50	0.833

# Complementary Brass Fittings

## Reducers, Olives and Nuts

This innovative reducer system, using a full range of nuts and olives, enables **different diameters** of steel, copper, brass or polymer tubes to be fitted onto **a single Parker Legris compression fitting**.

### Product Advantages

#### Efficient Solution

Reduces envelope dimensions  
Quick and easy to assemble, whatever the diameters and tube material  
Improved stock management  
Silicone-free

#### Multiple Combinations

A single connector for up to 4 different tube materials and sizes  
Example:
 

- polymer tube 4 mm O.D.
- copper tube 8 mm O.D.
- brass tube 12 mm O.D.
- braided PVC hose 12 mm I.D.

 A full range of olives and nuts to optimise all assembly operations



Pneumatics  
Cooling  
Automotive Process  
Lubrication  
Fluid Transmission  
Packaging  
Industrial Machinery

Applications

#### Regulations

DI: 97/23/EC (PED)  
RG: 1907/2006 (REACH)  
DI: 2002/95/EC (RoHS)  
DI: 94/9/EC (ATEX)

### Reducer Assembly Procedure

Operation	Assembly Sequence	Assembled Fitting
<p><b>1</b> <b>Assemble the reducer</b> Place the reducer in the fitting body.</p>	<p><b>1</b></p>	
<p><b>2</b> <b>Assemble the nut and olive</b> Place the nut and then the olive onto the tube.</p>	<p><b>2</b></p>	
<p><b>3</b> <b>Assemble the nut</b> Push the tubing into the fitting until it butts against the tube reducer. Tighten the nut to the recommended torque (see opposite page).</p>	<p><b>3</b></p>	

# Complementary Brass Fittings

## Assembly Configuration

The table and information given below illustrate the large number of options available with Parker Legris brass compression fittings. To these must be added the advantages specific to the original Parker Legris reducer shown on the previous page.



0110 Brass			0110..60 Brass		0110..40 Steel	0110..70* Polymer
0124 Brass			0124 Brass	0111 BNA** Brass	0124...40 Steel	
No olive required to assemble the plug						No olive required to assemble the tube
Brass plug: <b>0126</b>	Copper, cold-rolled brass, polymer tube and barb connectors <b>0122</b> and <b>0165</b>	Coiled annealed copper tube	Cold-rolled copper tube for vibration and side loading, etc.	Coiled annealed copper tube for vibration and side loading, etc.	Steel or copper tube: low/medium hydraulic pressure, lubricate before assembly	Polymer tube

### \*Assembly specifications for nut-olive 0110..70

This part functions as both olive and nut for flexible polymer tube assemblies:

1. Hand tighten the polymer nut-olive a few turns onto the body of the fitting; the knurling makes this easier.
2. Then introduce the polymer tube and push home into the body of the fitting.
3. Continue manually tightening the polymer nut-olive.
4. Finish tightening using a spanner until the nut body disengages and turns freely, which acts as a torque limiter.

**N.B.:** To avoid damaging the threads, do not insert the tube before hand tightening the nut-olive into the body of the fitting.

\*\*Bureau de Normalisation de l'Automobile (French Automotive Bureau of Standards)

### Recommended Tightening Torque

#### Tightening torque

in daN.m =

maximum tightening torque of a **0110** nut and **0124** olive with copper, brass or steel tube.

Nut **0110** and **0110..40**

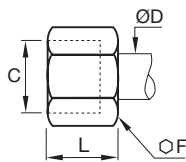

Nut **0110..60**

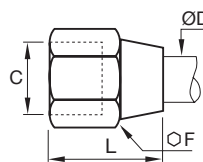

Ø D (mm)	Ø F 0110	Ø F 0110..60	max. daN.m copper or brass	Ø F 0110..40	max. daN.m steel
4	10	11	0.7	10	1.5
5	12	13	0.7	12	1.5
6	13	13	1.5	13	2.5
8	14	16	1.5	14	2.5
10	19	20	1.8	19	3
12	22	22	3	22	4.5
14	24	24	3.5	24	5.5
15	24	24	4	24	6
16	27	27	5	27	7
18	30	30	6	30	9
20	32	32	6	32	10
22	36	36	7	36	12
25	41	41	8	41	13
28	42		9		

# Complementary Brass Compression Fittings

**0166**

3-Piece Reducer

Brass

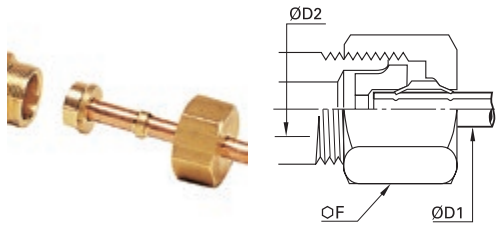

ØD1	ØD2		F	Kg
4	5	<a href="#">0166 04 05</a>	13	0.011
	6	<a href="#">0166 04 06</a>	13	0.011
	8	<a href="#">0166 04 08</a>	14	0.012
	10	<a href="#">0166 04 10</a>	19	0.030
	12	<a href="#">0166 04 12</a>	22	0.044
5	14	<a href="#">0166 04 14</a>	24	0.054
	15	<a href="#">0166 04 15</a>	24	0.056
	6	<a href="#">0166 05 06</a>	13	0.011
	8	<a href="#">0166 05 08</a>	14	0.012
	10	<a href="#">0166 05 10</a>	19	0.030
6	12	<a href="#">0166 05 12</a>	22	0.044
	14	<a href="#">0166 05 14</a>	24	0.053
	16	<a href="#">0166 05 16</a>	27	0.078
	8	<a href="#">0166 06 08</a>	14	0.011
	10	<a href="#">0166 06 10</a>	19	0.030
8	12	<a href="#">0166 06 12</a>	22	0.043
	14	<a href="#">0166 06 14</a>	24	0.052
	15	<a href="#">0166 06 15</a>	24	0.054
	16	<a href="#">0166 06 16</a>	27	0.077
	10	<a href="#">0166 08 10</a>	19	0.027
10	12	<a href="#">0166 08 12</a>	22	0.040
	14	<a href="#">0166 08 14</a>	24	0.050
	15	<a href="#">0166 08 15</a>	24	0.052
	16	<a href="#">0166 08 16</a>	27	0.077
	18	<a href="#">0166 08 18</a>	30	0.099
12	12	<a href="#">0166 10 12</a>	22	0.037
	14	<a href="#">0166 10 14</a>	24	0.045
	15	<a href="#">0166 10 15</a>	24	0.047
	16	<a href="#">0166 10 16</a>	27	0.068
	18	<a href="#">0166 10 18</a>	30	0.095
14	20	<a href="#">0166 10 20</a>	32	0.107
	22	<a href="#">0166 10 22</a>	36	0.146
	25	<a href="#">0166 10 25</a>	41	0.209
	14	<a href="#">0166 12 14</a>	24	0.042
	15	<a href="#">0166 12 15</a>	24	0.044
16	16	<a href="#">0166 12 16</a>	27	0.066
	18	<a href="#">0166 12 18</a>	30	0.091
	20	<a href="#">0166 12 20</a>	32	0.102
	22	<a href="#">0166 12 22</a>	36	0.141
	25	<a href="#">0166 12 25</a>	41	0.200
18	16	<a href="#">0166 14 16</a>	27	0.060
	18	<a href="#">0166 14 18</a>	30	0.085
	20	<a href="#">0166 14 20</a>	32	0.095
	22	<a href="#">0166 14 22</a>	36	0.134
	25	<a href="#">0166 14 25</a>	41	0.189
15	18	<a href="#">0166 15 18</a>	30	0.081
	22	<a href="#">0166 15 22</a>	36	0.130
	18	<a href="#">0166 16 18</a>	30	0.078
16	20	<a href="#">0166 16 20</a>	32	0.087
	22	<a href="#">0166 16 22</a>	36	0.125
	25	<a href="#">0166 16 25</a>	41	0.185
20	20	<a href="#">0166 18 20</a>	32	0.082
	22	<a href="#">0166 18 22</a>	36	0.118
	25	<a href="#">0166 18 25</a>	41	0.180
	28	<a href="#">0166 18 28</a>	42	0.177
25	20	<a href="#">0166 20 25</a>	41	0.168
	22	<a href="#">0166 22 28</a>	42	0.168

ØD1: tube to be fitted

ØD2: for a x mm fitting

Each of the above part numbers comprises:

- a reduction piece
- an olive, PN 0124
- a sleeve nut

# Complementary Brass Compression Fittings

## 0124 Brass Olive

Brass

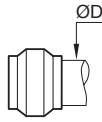

ØD		Kg
4	<a href="#">0124 04 00</a>	0.001
5	<a href="#">0124 05 00</a>	0.001
6	<a href="#">0124 06 00</a>	0.001
8	<a href="#">0124 08 00</a>	0.001
10	<a href="#">0124 10 00</a>	0.003
12	<a href="#">0124 12 00</a>	0.004
14	<a href="#">0124 14 00</a>	0.005
15	<a href="#">0124 15 00</a>	0.004
16	<a href="#">0124 16 00</a>	0.006
18	<a href="#">0124 18 00</a>	0.007
20	<a href="#">0124 20 00</a>	0.009
22	<a href="#">0124 22 00</a>	0.012
25	<a href="#">0124 25 00</a>	0.017
28	<a href="#">0124 28 00</a>	0.017

## 0124..40 Steel Olive

Zinc-plated steel

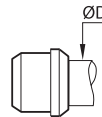

ØD		Kg
4	<a href="#">0124 04 00 40</a>	0.001
6	<a href="#">0124 06 00 40</a>	0.001
8	<a href="#">0124 08 00 40</a>	0.001
10	<a href="#">0124 10 00 40</a>	0.003
12	<a href="#">0124 12 00 40</a>	0.003
14	<a href="#">0124 14 00 40</a>	0.005
15	<a href="#">0124 15 00 40</a>	0.004
16	<a href="#">0124 16 00 40</a>	0.006
18	<a href="#">0124 18 00 40</a>	0.007
20	<a href="#">0124 20 00 40</a>	0.008
22	<a href="#">0124 22 00 40</a>	0.010
25	<a href="#">0124 25 00 40</a>	0.014

## 0111 BNA\* Brass Olive

Brass

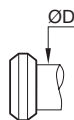

ØD		Kg
4	<a href="#">0111 04 00</a>	0.001
5	<a href="#">0111 05 00</a>	0.001
6	<a href="#">0111 06 00</a>	0.001
8	<a href="#">0111 08 00</a>	0.001
10	<a href="#">0111 10 00</a>	0.002
12	<a href="#">0111 12 00</a>	0.002
14	<a href="#">0111 14 00</a>	0.002
15	<a href="#">0111 15 00</a>	0.003
16	<a href="#">0111 16 00</a>	0.003

\*Bureau de Normalisation de l'Automobile

### Related Products

Parker also offers another type of brass compression fitting: **Metrulok**, with a one-piece olive/nut.

Do not hesitate to contact us.



# Complementary Brass Compression Fittings

## 0110 Brass Nut

Brass

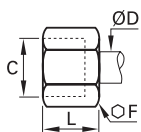

ØD	C		F	L	Kg
4	M8x1	<a href="#">0110 04 00</a>	10	11	0.005
5	M10x1	<a href="#">0110 05 00</a>	12	11	0.006
6	M10x1	<a href="#">0110 06 00</a>	13	11	0.008
8	M12x1	<a href="#">0110 08 00</a>	14	13	0.009
10	M16x1.5	<a href="#">0110 10 00</a>	19	15	0.018
12	M18x1.5	<a href="#">0110 12 00</a>	22	15	0.026
14	M20x1.5	<a href="#">0110 14 00</a>	24	15	0.029
15	M20x1.5	<a href="#">0110 15 00</a>	24	15	0.029
16	M22x1.5	<a href="#">0110 16 00</a>	27	17	0.042
18	M24x1.5	<a href="#">0110 18 00</a>	30	18	0.055
20	M27x1.5	<a href="#">0110 20 00</a>	32	18	0.057
22	M30x1.5	<a href="#">0110 22 00</a>	36	19	0.080
25	M33x1.5	<a href="#">0110 25 00</a>	41	21	0.121
28	M36x1.5	<a href="#">0110 28 00</a>	42	21	0.108

## 0110..40 Steel Nut

Zinc-plated steel

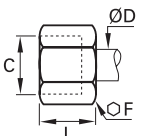

ØD	C		F	L	Kg
4	M8x1	<a href="#">0110 04 00 40</a>	10	11	0.004
5	M10x1	<a href="#">0110 05 00 40</a>	12	11.5	0.006
6	M10x1	<a href="#">0110 06 00 40</a>	13	12	0.008
8	M12x1	<a href="#">0110 08 00 40</a>	14	13.5	0.008
10	M16x1.5	<a href="#">0110 10 00 40</a>	19	16	0.018
12	M18x1.5	<a href="#">0110 12 00 40</a>	22	16.5	0.026
14	M20x1.5	<a href="#">0110 14 00 40</a>	24	17	0.030
15	M20x1.5	<a href="#">0110 15 00 40</a>	24	17	0.030
16	M22x1.5	<a href="#">0110 16 00 40</a>	27	18	0.043
18	M24x1.5	<a href="#">0110 18 00 40</a>	30	19	0.057
20	M27x1.5	<a href="#">0110 20 00 40</a>	32	20.5	0.061
22	M30x1.5	<a href="#">0110 22 00 40</a>	36	21.5	0.085

## 0110..60 Brass Long Nut

Brass

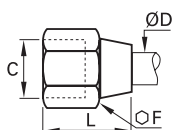

ØD	C		F	L	Kg
4	M8x1	<a href="#">0110 04 00 60</a>	11	14.5	0.007
5	M10x1	<a href="#">0110 05 00 60</a>	13	17	0.008
6	M10x1	<a href="#">0110 06 00 60</a>	13	17.5	0.011
8	M12x1	<a href="#">0110 08 00 60</a>	16	20	0.019
10	M16x1.5	<a href="#">0110 10 00 60</a>	20	23	0.032
12	M18x1.5	<a href="#">0110 12 00 60</a>	22	25	0.039
14	M20x1.5	<a href="#">0110 14 00 60</a>	24	30	0.051
15	M20x1.5	<a href="#">0110 15 00 60</a>	24	30	0.049
18	M24x1.5	<a href="#">0110 18 00 60</a>	30	35	0.098
20	M27x1.5	<a href="#">0110 20 00 60</a>	32	35	0.102
22	M30x1.5	<a href="#">0110 22 00 60</a>	36	36	0.129

## 0110..70 Technical Polymer Nut-Olive

Technical polymer

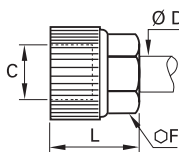

ØD	C		F	L	Kg
4	M8x1	<a href="#">0110 04 00 70</a>	8	13	0.008
6	M10x1	<a href="#">0110 06 00 70</a>	11	15	0.002
8	M12x1	<a href="#">0110 08 00 70</a>	13	16	0.002
10	M16x1.5	<a href="#">0110 10 00 70</a>	17	19	0.004
12	M18x1.5	<a href="#">0110 12 00 70</a>	19	19	0.005
14	M20x1.5	<a href="#">0110 14 00 70</a>	22	20	0.005

NB: polymer nut-olives should not be used on metal tubes.





Brass Compression Fittings

Compression Fittings



# Self-Fastening Barb Connectors for NBR Hose

This range of fittings is designed to meet the requirements of the automotive and robotics industries, combining as it does **optimum CNOMO manufacturing quality**, simple installation, reliable operation and a **long service life**.

## Product Advantages

### Perfect for Self-Fastening NBR Hose

- Quick and simple to install
- Compatible with the Parker Legris range of brass compression fittings
- Mechanical properties proven for use in industrial robotic installations
- Spark-resistant

### Ergonomic and Time-Saving

- Fitting does not require lubrication or clamping, reducing assembly time
- Visual stop confirms installation is correct and improves operating safety
- Removal by cutting the tube
- The fitting can be re-used if necessary



Applications

- Welding Robots
- Pneumatics
- Compressed Air Systems
- Automotive Process
- Cooling

## Technical Characteristics

<b>Compatible Fluids</b>	Coolants, compressed air
<b>Working Pressure</b>	0 to 16 bar
<b>Working Temperature</b>	0°C to +100°C (water) -20°C to +70°C (air)

<b>Tightening Torque, Type 0132</b>	DN	6	8	10	14	18	22
	daN.m	0.7	1.5	1.8	3.5	6	7

Reliable performance is dependent upon the type of fluid conveyed and hose being used.

### Component Materials

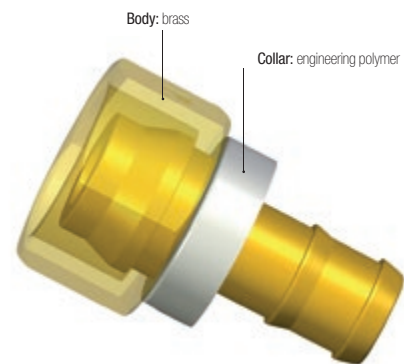

Silicone-free

### Self-Fastening Hose Assembly Machine

Machine designed to assemble a barb connector and a self-fastening NBR hose.

Machine part number: **0650 00 00 05**



#### Tube Cutting and Positioning

Cut the hose square and position the barb connector on the mounting tool.

Barb Connector Support

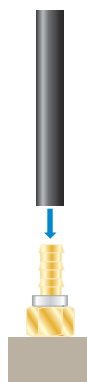

#### Press-Fitting the Tube

Activate the press-fit tool; connection is complete when the tube is fully home on the barb connector. This tool has been designed for use with 5 different diameters and is easy to operate.

Barb Connector Support

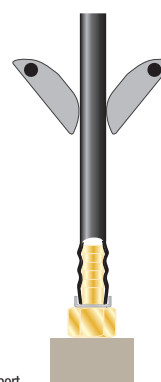

### Regulations

#### Industrial

DI: 2002/95/EC (RoHS), 2011/65/EC

DI: 97/23/EC (PED)

RG: 1907/2006 (REACH)

CNOMO: E07.21.115N

# Self-Fastening Barb Connectors for NBR Hose

## 0132 Self-Fastening Barb Connector for Brass Compression Fitting

Brass

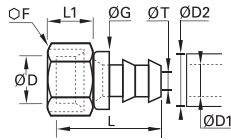

ØD	ØD1	ØD2		F	G	L	L1	ØT	Kg
6	6.3	13	<a href="#">0132 06 56</a>	12	16.5	32.5	12.5	4.8	0.010
8	6.3	13	<a href="#">0132 08 56</a>	14	16.5	29.5	11.5	4.8	0.015
10	6.3	13	<a href="#">0132 10 56</a>	19	16.5	30	14	4.8	0.028
	9.5	16	<a href="#">0132 10 60</a>	19	19.5	34	14	7.5	0.030
14	9.5	16	<a href="#">0132 14 60</a>	24	19.5	35.5	15	7.5	0.050
	12.7	19	<a href="#">0132 14 62</a>	24	23.5	39.5	15	10	0.054
18	12.7	19	<a href="#">0132 18 62</a>	30	23.5	41.5	17	10	0.090
	15.9	23	<a href="#">0132 18 66</a>	30	27	50	17	13.5	0.090
22	19.1	27	<a href="#">0132 22 69</a>	36	30.5	56.5	17	16	0.128

Polymer collar

## 0133..39 Self-Fastening Bar Connector with Bi-Material Seal, Male BSPP Thread

Brass, zinc-plated steel with NBR seal

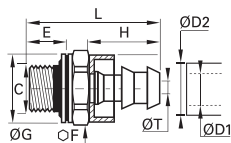

ØD1	ØD2	C		E	F	G	H	L	ØT	Kg
6.3	13	G1/8	<a href="#">0133 56 10 39</a>	5.5	13	14	20	31.5	4.8	0.012
		G1/4	<a href="#">0133 56 13 39</a>	7	17	17	20	33.5	4.8	0.018
9.5	16	G1/4	<a href="#">0133 60 13 39</a>	7	17	17	24	37.5	7.5	0.021
		G3/8	<a href="#">0133 60 17 39</a>	9.5	22	22	24	42.5	7.5	0.038
12.7	19	G3/8	<a href="#">0133 62 17 39</a>	9.5	22	22	28	46.5	10	0.044
		G1/2	<a href="#">0133 62 21 39</a>	10.5	27	26	28	48.5	10	0.060
15.9	23	G1/2	<a href="#">0133 66 21 39</a>	10.5	27	26	36.5	57	13.5	0.063
		G3/4	<a href="#">0133 66 27 39</a>	11.5	32	32	36.5	59	13.5	0.096
19.1	27	G3/4	<a href="#">0133 69 27 39</a>	11.5	32	32	43	65.5	16	0.111

Thread with bi-material seal and polymer collar  
Bi-material sealing washers part number 0139 can be found in chapter 9.

## 0134 Self-Fastening Barb Connector, Male BSPT Thread

Brass

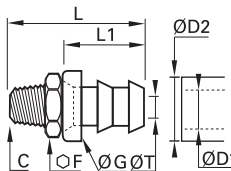

ØD1	ØD2	C		F	G	L	L1	ØT	Kg
6.3	13	R1/8	<a href="#">0134 56 10</a>	14	16.5	32.5	20	4.8	0.015
		R1/4	<a href="#">0134 56 13</a>	14	16.5	37	20	4.8	0.020
9.5	16	R1/4	<a href="#">0134 60 13</a>	14	19.5	41	24	7.5	0.022
		R3/8	<a href="#">0134 60 17</a>	19	19.5	41.5	24	7.5	0.036
12.7	19	R3/8	<a href="#">0134 62 17</a>	19	23.5	45.5	28	10	0.038
		R1/2	<a href="#">0134 62 21</a>	22	23.5	50	28	10	0.062
15.9	23	R1/2	<a href="#">0134 66 21</a>	22	27	58.5	36.5	13.5	0.056
		R3/4	<a href="#">0134 66 27</a>	27	27	60.5	36.5	13.5	0.101
19.1	27	R3/4	<a href="#">0134 69 27</a>	27	30.5	67	43	16	0.108

Polymer collar

Self-fastening NBR hose is selected by nominal diameter; for example:

Barb Connector	O.D. (Tube)	Ø DN (Tube)	Self-Fastening NBR hose
<b>0132 10 56</b>	<b>10</b>	<b>1/4</b>	<b>10..H 56...</b>



# Brass Adaptors

## 0122 Barb Connector for Hose

Brass

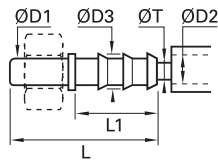

ØD1	ØD2		ØD3	L	L1	ØT min	Kg
4	4	<a href="#">0122 04 04</a>	6	37.5	22.5	3	0.004
5	4	<a href="#">0122 05 04</a>	6	37.5	22.5	3	0.003
6	4	<a href="#">0122 06 04</a>	6	37.5	22.5	3	0.005
	7	<a href="#">0122 06 07</a>	9	37.5	22.5	6	0.007
8	6	<a href="#">0122 08 06</a>	8	40	22.5	5	0.007
	7	<a href="#">0122 08 07</a>	9	40	22.5	6	0.008
	10	<a href="#">0122 08 10</a>	12.5	40	22.5	9	0.012
10	7	<a href="#">0122 10 07</a>	9	43	22.5	6	0.010
	10	<a href="#">0122 10 10</a>	12.5	43	22.5	9	0.014
12	10	<a href="#">0122 12 10</a>	12.5	43	22.5	9	0.013
	13	<a href="#">0122 12 13</a>	15	50	29.5	12	0.018
14	13	<a href="#">0122 14 13</a>	15	52	29.5	12	0.019
	16	<a href="#">0122 14 16</a>	18.5	60.5	38	15	0.031
15	13	<a href="#">0122 15 13</a>	15	52	29.5	12	0.020
	16	<a href="#">0122 15 16</a>	18.5	60.5	38	15	0.032
16	13	<a href="#">0122 16 13</a>	15	53.5	29.5	12	0.021
	16	<a href="#">0122 16 16</a>	18.5	62	38	15	0.032
18	16	<a href="#">0122 18 16</a>	18.5	62	38	15	0.032
	19	<a href="#">0122 18 19</a>	21.5	62	38	18	0.040
20	16	<a href="#">0122 20 16</a>	18.5	64	38	15	0.034
	19	<a href="#">0122 20 19</a>	21.5	64	38	18	0.039
22	19	<a href="#">0122 22 19</a>	21.5	64	38	18	0.041
25	19	<a href="#">0122 25 19</a>	21.5	70	38	18	0.048
	25	<a href="#">0122 25 25</a>	27.5	70	38	24	0.054
28	25	<a href="#">0122 28 25</a>	27.5	70	38	24	0.087

## 0165 Barb Connector for Flexible Tubing

Brass

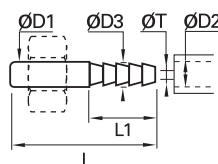

ØD1	ØD2		ØD3	L	L1	ØT min	Kg
4	4	<a href="#">0165 04 06</a>	4.3	30	15	2	0.002
5	4	<a href="#">0165 05 06</a>	4.3	30	15	2	0.003
6	4	<a href="#">0165 06 06</a>	4.3	30	15	2	0.003
	6	<a href="#">0165 06 08</a>	6.4	30	15	4	0.004
8	8	<a href="#">0165 06 10</a>	8.4	30	15	4	0.004
	6	<a href="#">0165 08 08</a>	6.4	32.5	15	4	0.005
8	8	<a href="#">0165 08 10</a>	8.4	32.5	15	6	0.006
	10	<a href="#">0165 08 12</a>	10.7	37.5	20	8	0.009
	8	<a href="#">0165 10 10</a>	8.4	35.5	15	6	0.008
10	10	<a href="#">0165 10 12</a>	10.7	40.5	20	8	0.010
	12	<a href="#">0165 10 14</a>	12.7	40.5	20	8	0.012
12	10	<a href="#">0165 12 12</a>	10.7	40.5	20	8	0.011
	12	<a href="#">0165 12 14</a>	12.7	40.5	20	10	0.012
14	12	<a href="#">0165 14 14</a>	12.7	42.5	20	10	0.015
15	13	<a href="#">0165 15 16</a>	13.7	42.5	20	11	0.015
16	13	<a href="#">0165 16 16</a>	13.7	44	20	11	0.018

### Assembly: Barb Connectors

Our barb connectors 0122 and 0165 are designed to be used with different types of hose. They are secured using the nut and olive provided with the fitting.

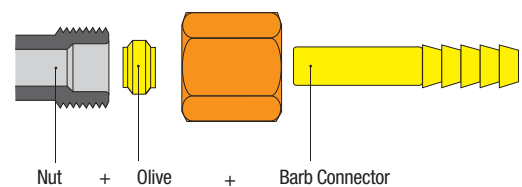

# Brass Adaptors

## 0126 Plug for Compression Fitting

Brass

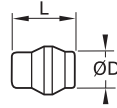

ØD		L	Kg
4	<a href="#">0126 04 00</a>	10	0.002
5	<a href="#">0126 05 00</a>	10	0.003
6	<a href="#">0126 06 00</a>	10	0.003
8	<a href="#">0126 08 00</a>	11.5	0.006
10	<a href="#">0126 10 00</a>	13	0.010
12	<a href="#">0126 12 00</a>	13	0.014
14	<a href="#">0126 14 00</a>	13.5	0.020
15	<a href="#">0126 15 00</a>	13.5	0.022
16	<a href="#">0126 16 00</a>	16	0.030
18	<a href="#">0126 18 00</a>	16	0.038
20	<a href="#">0126 20 00</a>	16	0.045
22	<a href="#">0126 22 00</a>	18	0.003
28	<a href="#">0126 28 00</a>	19.5	0.108

The plug is used to blank off an outlet in a compression fitting, replacing the olive.

When an open outlet is required, simply dismantle and replace the plug with the tube olive, reusing the nut. The plug is also reusable.

## 0125 Tube End Plug for Compression Fitting

Brass

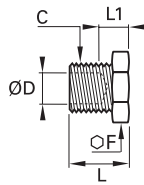

ØD	C		F	L	L1	Kg
4	M8x1	<a href="#">0125 04 00</a>	10	12	8	0.006
6	M10x1	<a href="#">0125 06 00</a>	11	13.5	9.5	0.008
8	M12x1	<a href="#">0125 08 00</a>	14	14	9	0.012
10	M16x1.5	<a href="#">0125 10 00</a>	17	18	11	0.025
12	M18x1.5	<a href="#">0125 12 00</a>	19	18	11	0.030
14	M20x1.5	<a href="#">0125 14 00</a>	22	19	11	0.041

This plug enables unused tubes to be blanked off.

The male thread on the plug has the same pitch as the female thread on the sleeve nut of a standard Parker Legris fitting.

Therefore the plug screwed into the sleeve nut blanks off the tube.

To reopen the passage, simply unscrew the plug and fit the required coupler.

No further treatment of the tube is required.

## 0220 Hex Head Plug, Male BSPP and Metric Thread

Brass, technical polymer

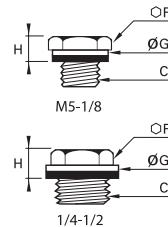

C		F	G	H1	Kg
M5x0.8	<a href="#">0220 19 00</a>	8	8	5	0.002
G1/8	<a href="#">0220 10 00</a>	14	14	7.5	0.011
G1/4	<a href="#">0220 13 00</a>	17	17	7.5	0.020
G3/8	<a href="#">0220 17 00</a>	17	22	8.5	0.024
G1/2	<a href="#">0220 21 00</a>	22	27	10	0.041

Thread with pre-assembled sealing washer

M5: with screwdriver slot for tightening

Maximum allowable working pressure = 20 bar

Part number with suffix 99, maximum allowable working pressure = 250 bar, example: 0220 19 00 99

Conforms to BNA 229 (with the exception of M5 model), BSPP thread, ISO ISO 228-1,

Parallel metric thread, ISO NFE 03-054

## 0220..39 Hex Head Plug with Bi-Material Seal, Male BSPP Thread

Brass, zinc-plated steel with NBR seal

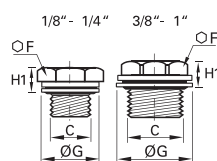

C		F	G	H	Kg
G1/8	<a href="#">0220 10 00 39</a>	14	14	6.5	0.012
G1/4	<a href="#">0220 13 00 39</a>	17	17	6.5	0.020
G3/8	<a href="#">0220 17 00 39</a>	17	22	8	0.025
G1/2	<a href="#">0220 21 00 39</a>	22	26	9	0.043
G3/4	<a href="#">0220 27 00 39</a>	22	32	10	0.060
G1	<a href="#">0220 34 00 39</a>	27	39.5	10.5	0.089

Plug with bi-material seal

Bi-material washers part number 0139 can be found in chapter 9.

# Brass Adaptors

## 0120

### Stud Standpipe, Male BSPT Thread

Brass

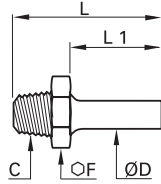

ØD	C		F	L	L1	Kg
4	R1/8	<a href="#">0120 04 10</a>	11	25.5	14	0.007
5	R1/8	<a href="#">0120 05 10</a>	11	26	14.5	0.007
6	R1/8	<a href="#">0120 06 10</a>	11	26.5	15	0.008
	R1/4	<a href="#">0120 06 13</a>	14	31	15	0.015
8	R1/8	<a href="#">0120 08 10</a>	11	28.5	17	0.009
	R1/4	<a href="#">0120 08 13</a>	14	33	17	0.016
	R3/8	<a href="#">0120 08 17</a>	17	33.5	17	0.020
10	R1/4	<a href="#">0120 10 13</a>	14	36	20	0.018
	R3/8	<a href="#">0120 10 17</a>	17	36.5	20	0.022
12	R1/2	<a href="#">0120 12 21</a>	22	41	20	0.040
	R1/4	<a href="#">0120 12 13</a>	14	36	20	0.018
14	R3/8	<a href="#">0120 12 17</a>	17	36.5	20	0.022
	R1/2	<a href="#">0120 12 21</a>	22	41	20	0.040
15	R3/8	<a href="#">0120 14 17</a>	17	38	21.5	0.023
	R1/2	<a href="#">0120 14 21</a>	22	42.5	21.5	0.041
16	R3/8	<a href="#">0120 15 17</a>	17	38	21.5	0.023
	R1/2	<a href="#">0120 15 21</a>	22	42.5	21.5	0.041
18	R3/8	<a href="#">0120 16 17</a>	17	39.5	23	0.024
	R1/2	<a href="#">0120 16 21</a>	22	44	23	0.042
20	R1/2	<a href="#">0120 18 21</a>	22	44.5	23.5	0.042
	R3/4	<a href="#">0120 18 27</a>	27	47.5	23.5	0.071
22	R3/4	<a href="#">0120 20 27</a>	27	49	25	0.070
	R3/4	<a href="#">0120 22 27</a>	27	48.5	25.5	0.067
25	R1	<a href="#">0120 22 34</a>	36	52.5	25.5	0.117
28	R1	<a href="#">0120 25 34</a>	36	57	30	0.118
		<a href="#">0120 28 34</a>	36	57	30	0.140

## 0112

### Sleeve Nut for Compression Fitting, Male Metric Thread

Brass

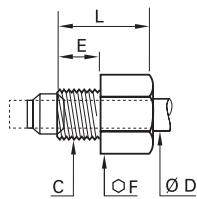

ØD	C		E	F	L	Kg
4	M8x1	<a href="#">0112 04 00</a>	7	10	13	0.005
5	M10x1	<a href="#">0112 05 00</a>	7.5	11	13.5	0.007
6	M10x1	<a href="#">0112 06 00</a>	7.5	11	13.5	0.006
8	M12x1	<a href="#">0112 08 00</a>	8	13	15	0.009
10	M16x1.5	<a href="#">0112 10 00</a>	11	17	18	0.018
12	M18x1.5	<a href="#">0112 12 00</a>	11	19	18	0.021
14	M20x1.5	<a href="#">0112 14 00</a>	11	22	18	0.026

This product was designed to allow the tube to be fitted directly into the tapped port in a body using a standard Parker Legris olive.

For the corresponding drawings (cavity for Parker Legris olive), please consult us.

# Brass Adaptors

## 0128..39 Stud Standpipe with Bi-Material Seal, Male BSPP Thread

Brass, zinc-plated steel with NBR seal

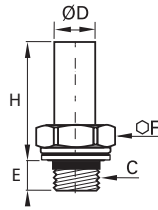

ØD	C		E	F	H	Kg
4	G1/8	<a href="#">0128 04 10 39</a>	7.5	13	20	0.009
	G1/4	<a href="#">0128 04 13 39</a>	9	17	22	0.015
6	G1/8	<a href="#">0128 06 10 39</a>	7.5	13	21	0.010
	G1/4	<a href="#">0128 06 13 39</a>	9	17	23	0.016
8	G1/8	<a href="#">0128 08 10 39</a>	7.5	13	23	0.011
	G1/4	<a href="#">0128 08 13 39</a>	9	17	25	0.017
	G3/8	<a href="#">0128 08 17 39</a>	12	22	26	0.032
10	G1/4	<a href="#">0128 10 13 39</a>	9	17	28	0.018
	G3/8	<a href="#">0128 10 17 39</a>	12	22	29	0.034
14	G1/2	<a href="#">0128 10 21 39</a>	27	27	30	0.049
	G3/8	<a href="#">0128 14 17 39</a>	12	22	30.5	0.035
18	G1/2	<a href="#">0128 14 21 39</a>	27	27	31.5	0.049
	G3/4	<a href="#">0128 18 21 39</a>	27	27	33.5	0.051
22	G3/4	<a href="#">0128 18 27 39</a>	14	32	34.5	0.084
	G1	<a href="#">0128 22 27 39</a>	14	32	36.5	0.082
28	G1	<a href="#">0128 22 34 39</a>	16.5	41	38	0.123
	G1	<a href="#">0128 28 34 39</a>	16.5	41	42.5	0.147

With bi-material seal. Bi-material washers part number 0139 can be found in Chapter 9.

## 0151..39 Straight Male Orientable Adaptor, with Bi-Material Seal, Male BSPP Thread

Brass, NBR, zinc-plated steel with NBR seal

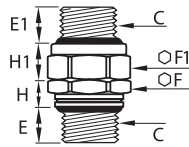

C		E	E1	F	F1	H	H1	Kg
G1/8	<a href="#">0151 10 10 39</a>	5.5	7	13	14	6	6.5	0.017
G1/4	<a href="#">0151 13 13 39</a>	7	8.5	17	19	6.5	9	0.036
G3/8	<a href="#">0151 17 17 39</a>	9.5	9.5	22	22	9	9	0.056
G1/2	<a href="#">0151 21 21 39</a>	10.5	10.5	27	27	10	10	0.083
G3/4	<a href="#">0151 27 27 39</a>	11.5	11.5	32	32	11	10	0.121
G1	<a href="#">0151 34 34 39</a>	13	13.5	41	41	12.5	10.5	0.217

With bi-material seal.

Bi-material washers part number 0139 can be found in Chapter 9.

## 0168..39 Reducer, with Bi-Material Seal, Male BSPP Thread/Female BSPP and Metric Thread

Brass, zinc-plated steel with NBR seal

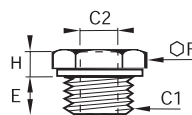

C1	C2		E	F	H	Kg
G1/8	M5x0.8	<a href="#">0168 10 19 39</a>	8	14	4.5	0.009
	M5x0.8	<a href="#">0168 13 19 39</a>	8	17	5	0.018
G1/4	G1/8	<a href="#">0168 13 10 39</a>	8	17	5	0.012
	G1/8	<a href="#">0168 17 10 39</a>	10	19	5	0.020
G3/8	G1/4	<a href="#">0168 17 13 39</a>	10	19	5	0.013
	G1/8	<a href="#">0168 21 10 39</a>	12	24	7.5	0.052
G1/2	G1/4	<a href="#">0168 21 13 39</a>	12	24	7.5	0.044
	G3/8	<a href="#">0168 21 17 39</a>	12	24	7.5	0.031
G3/4	G1/4	<a href="#">0168 27 13 39</a>	12	32	9.5	0.100
	G3/8	<a href="#">0168 27 17 39</a>	12	32	9.5	0.086
G1/2	<a href="#">0168 27 21 39</a>	12	32	9.5	0.065	

With bi-material seal.

Bi-material washers part number 0139 can be found in Chapter 9.

# Brass Adaptors

**0127**

## Brass Tube Support for Polymer Tubing

Brass

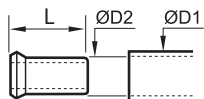

ØD1	ØD2		L	Kg
4	2	<a href="#">0127 04 00</a>	11	0.001
	2.7	<a href="#">0127 04 27</a>	11	0.001
5	3	<a href="#">0127 05 03</a>	11	0.001
	3.3	<a href="#">0127 05 00</a>	11.5	0.009
6	4	<a href="#">0127 06 00</a>	11.5	0.001
	5.5	<a href="#">0127 08 55</a>	14	0.001
8	6	<a href="#">0127 08 00</a>	14	0.001
	7	<a href="#">0127 10 07</a>	18	0.001
10	7.5	<a href="#">0127 10 75</a>	18	0.001
	8	<a href="#">0127 10 00</a>	18	0.002
12	8	<a href="#">0127 12 08</a>	18	0.002
	9	<a href="#">0127 12 09</a>	18	0.002
14	10	<a href="#">0127 12 00</a>	18	0.001
	11	<a href="#">0127 14 11</a>	18	0.002
15	12	<a href="#">0127 14 00</a>	18	0.002
	12	<a href="#">0127 15 12</a>	18	0.002
16	13	<a href="#">0127 16 13</a>	18	0.003
18	14	<a href="#">0127 18 14</a>	19.5	0.003
20	15	<a href="#">0127 20 15</a>	20.5	0.003
22	16	<a href="#">0127 22 16</a>	21	0.004
25	19	<a href="#">0127 25 19</a>	25	0.007

This tube support guarantees good gripping, at high temperatures and pressures, by preventing collapsing of the tube.

# Stainless Steel Compression Fitting Range

## Stainless Steel Fittings

### Stud Fittings

**1805**  
BSPT  
Page 5-34

**1805**  
NPT  
Page 5-34

**1814**  
BSPP  
Page 5-34

**1809**  
BSPT  
Page 5-35

**1809**  
NPT  
Page 5-35

**1820**  
BSPT  
Page 5-35

**1820**  
NPT  
Page 5-35



### Tube-to-Tube Fittings

**1806**  
Page 5-36

**1816**  
Page 5-36

**1802**  
Page 5-36

**1804**  
Page 5-36



### Complementary Fittings

**1866**  
Page 5-39

**1824**  
Page 5-39

**1810**  
Page 5-39



### Accessories

**1822**  
Page 5-39

**1827**  
Page 5-39



Stainless Steel  
Compression Fittings

Compression Fittings



# Stainless Steel Compression Fittings

**Manufactured in 316L stainless steel**, these fittings combine all the advantages of the "universal" compression fitting with **excellent resistance** to environmental conditions and **corrosive fluids**. They are pressure and temperature-resistant and are able to withstand strong vibration and water hammer.

## Product Advantages

### For Use in Many Environments

Manufactured in 316L stainless steel  
 Suitable for all environments and fluids  
 Resistant to water hammer and vibration  
 Excellent sealing and retention of the tube  
 Suitable for pneumatic and medium pressure hydraulic applications  
 Metallic sealing guarantees maximum service life

### Many Tube Options

Possibility of easily connecting different tube materials and diameters to the same fitting body  
 No tube support required for rigid and semi-rigid polyamide tubing below 12 mm



Food Process  
 Fluid Transmission  
 Pneumatics  
 Automotive Process  
 Petrochemical  
 Chemical  
 Offshore Oil & Gas

Applications

## Technical Characteristics

<b>Compatible Fluids</b>	Many fluids					
<b>Working Pressure</b>	Vacuum to 400 bar (80 bar in corrosive environments)					
<b>Working Temperature</b>	-60°C to +250°C with metal tubing					

<b>Tightening Torques</b>	DN	6	8	10	12	16
	daN.m	2	3	4	6.5	9.5

Reliable performance is dependent upon the type of fluid conveyed and tubing being used. Guaranteed for use with a vacuum of 755 mm Hg (99% vacuum). Thread sealing must be guaranteed by user.

### Component Materials

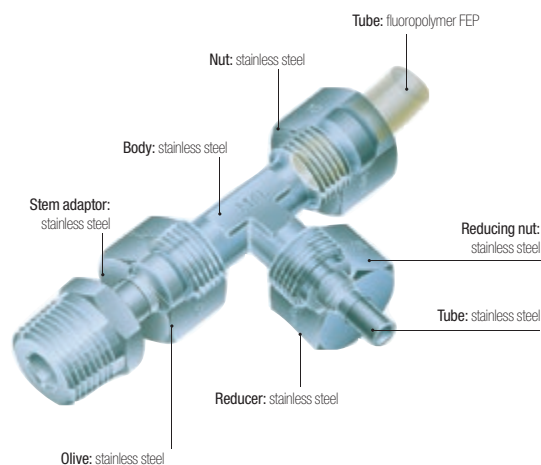

Silicone-free

### Maximum Bore Diameters

The table below shows the recommended compatibility of tube size, BSPP male thread and maximum bore.

Tube O.D	BSPP Thread	Max. Bore
6	G1/8	4
6-8-10	G1/4	7
10-12	G3/8	11
16	G1/2	14

### Tube Length for Assembly

Minimum length of tube (L) between 2 fittings.

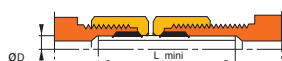

ØD	L mm	ØD	L mm
4	26.5	10	39
6	26	12	39
8	32	16	46.5

### Regulations

DI: 2002/95/EC (RoHS), 2011/65/EC  
 DI: 97/23/EC (PED)  
 RG: 1935/2004  
 RG: 1907/2006 (REACH)  
 DI: 94/09/EC (ATEX)  
 FDA: 21 CFR 177.1550  
 NACE MR0175: compatible materials  
 ISO 15156-1/-2/-3: compatible materials

# Stainless Steel Compression Fittings

## Installation

### Fitting

The fitting comprises three parts (body/olive/nut). For assembly procedure, please see Brass Compression Fitting page.

### Diagram: Assembled Fitting

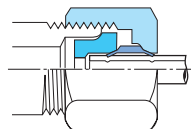

A very slight distortion of the tube appears; this shows the fitting has been correctly tightened.

### Orientable Elbow Assembly

Elbow  
**1802**

Adaptor  
**1820**

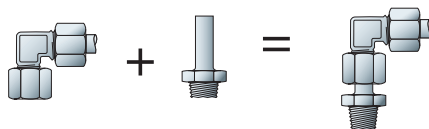

### Customised Fittings

If our standard range does not meet your needs, Parker Legris can develop customised solutions for your applications.

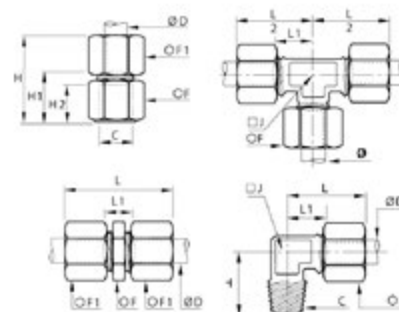

## Technical Characteristics

The use of Parker Legris stainless steel compression fittings is dependant on the tube material. Tables of recommended working pressure for the different tubes are shown below.

### Recommended Tube Type

#### Semi-rigid polyamide or fluoropolymer tube

#### Stainless steel tube

"Thin Wall" cold-drawn seamless, annealed and passivated: wall thickness tolerance  $\pm 0.1$  mm. For use with "thin wall" stainless steel tube from 6 mm to 16 mm O.D., maximum wall thickness 1 mm.

### Recommended Tube/Fitting Assembly Configurations

Assembled using Parker Legris olive and nut in stainless steel, with a tube support.

#### Stainless steel tube

Stainless steel tube: in cold-rolled straight lengths  
Coiled annealed stainless tube: reduces working pressure by 35%; do not use if there is vibration.

#### Semi-Rigid Polyamide Tube

Maximum Working Pressure (bar)

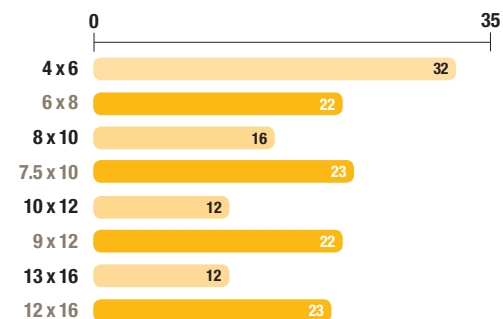

#### Stainless Steel Tube

Maximum Working Pressure (bar)

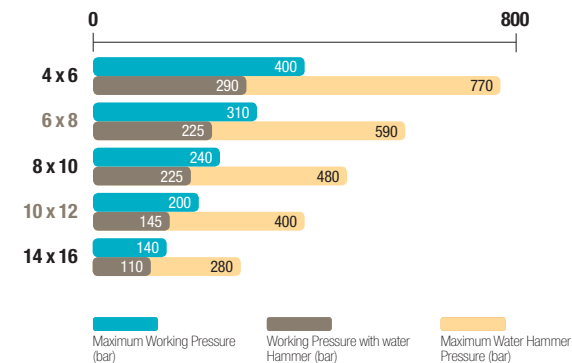

### Working Pressure Coefficients for Semi-Rigid Tubing

Temperature °C	-40°C / -15°C	-15°C / +30°C	+30°C / +50°C	+50°C / +70°C	+70°C / +100°C
Factor	1.8	1	0.68	0.55	0.31

The above recommendations are given in good faith. However, since each application is different, it is advisable to undertake tests in actual working conditions.

# Stainless Steel Compression Fittings

## 1805 Stud Fitting, Male BSPT Thread

Stainless steel 316L

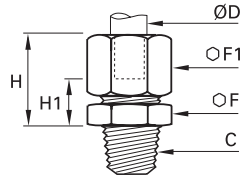

ØD	C		F	F1	H <sub>max</sub>	H1	Kg
6	R1/8	1805 06 10	12	13	19.5	7.5	0.017
	R1/4	1805 06 13	14	13	19.5	7.5	0.024
8	R1/8	1805 08 10	13	14	21	7	0.019
	R1/4	1805 08 13	14	14	21	7	0.025
10	R1/4	1805 10 13	17	19	25.5	9	0.043
	R3/8	1805 10 17	17	19	25.5	9	0.049
	R1/2	1805 10 21	22	19	26.5	10	0.077
12	R1/4	1805 12 13	19	22	26	9	0.054
	R3/8	1805 12 17	19	22	26	9	0.057
	R1/2	1805 12 21	22	22	27	10	0.081
16	R3/8	1805 16 17	24	27	28.5	9.5	0.085
	R1/2	1805 16 21	24	27	28.5	9.5	0.095

## 1805 Stud Fitting, Male NPT Thread

Stainless steel 316L

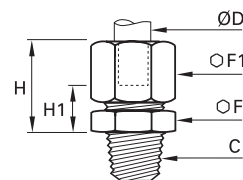

ØD	C		F	F1	H <sub>max</sub>	H1	Kg
6	NPT1/8	1805 06 11	12	13	19.5	7.5	0.018
	NPT1/4	1805 06 14	14	13	19.5	7.5	0.027
	NPT3/8	1805 06 18	19	13	20.5	8.5	0.033
8	NPT1/2	1805 06 22	22	13	21.5	9.5	0.049
	NPT1/8	1805 08 11	13	14	21	7	0.020
	NPT1/4	1805 08 14	14	14	21	7	0.027
10	NPT1/4	1805 10 14	17	19	25.5	9	0.046
	NPT3/8	1805 10 18	19	19	25.5	9	0.055
	NPT1/2	1805 10 22	22	19	26.5	10	0.081
12	NPT1/4	1805 12 14	19	22	26	9	0.056
	NPT3/8	1805 12 18	19	22	26	9	0.060
	NPT1/2	1805 12 22	22	22	27	10	0.087
16	NPT3/8	1805 16 18	24	27	28.5	9.5	0.087
	NPT1/2	1805 16 22	24	27	28.5	9.5	0.097

## 1814 Stud Fitting, Female BSPP Thread

Stainless steel 316L

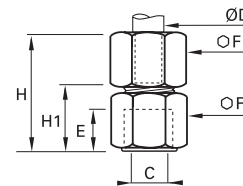

ØD	C		E	F	F1	H <sub>max</sub>	H1	Kg
6	G1/8	1814 06 10	7.5	14	13	29	17	0.023
	G1/4	1814 06 13	11	17	13	29	21	0.032
8	G1/4	1814 08 13	11	17	14	34.5	20.5	0.033
	G3/8	1814 10 17	11.5	22	19	38.5	22	0.064
10	G1/2	1814 10 21	15	27	19	43	26.5	0.094
	G3/8	1814 12 17	11.5	22	22	39	22	0.073
12	G1/2	1814 12 21	15	27	22	43.5	26.5	0.103
	G1/2	1814 16 21	15	27	27	45	26	0.121

# Stainless Steel Compression Fittings

## 1809 Stud Elbow, Male BSPT Thread

Stainless steel 316L

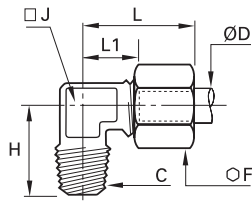

ØD	C		F	H	J	L <sub>max</sub>	L1	Kg
6	R1/8	<a href="#">1809 06 10</a>	13	18	8	25.5	13.5	0.020
	R1/4	<a href="#">1809 06 13</a>	13	23	10	25.5	13.5	0.029
8	R1/8	<a href="#">1809 08 10</a>	14	20.5	10	28.5	14.5	0.026
	R1/4	<a href="#">1809 08 13</a>	14	23	10	28.5	14.5	0.030
10	R1/4	<a href="#">1809 10 13</a>	19	25	12	32.5	16	0.050
	R3/8	<a href="#">1809 10 17</a>	19	25.5	12	32.5	16	0.058
12	R1/2	<a href="#">1809 10 21</a>	19	32	18	36.5	20	0.093
	R1/4	<a href="#">1809 12 13</a>	22	26	14	34	17	0.067
16	R3/8	<a href="#">1809 12 17</a>	22	27	14	34	17	0.069
	R1/2	<a href="#">1809 12 21</a>	22	32	18	37	20	0.100
16	R3/8	<a href="#">1809 16 17</a>	27	28.5	18	39.5	21	0.108
	R1/2	<a href="#">1809 16 21</a>	27	31.5	18	39.5	21	0.115

## 1809 Stud Elbow, Male NPT Thread

Stainless steel 316L

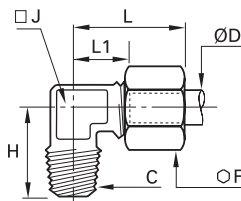

ØD	C		F	H	J	L <sub>max</sub>	L1	Kg
6	NPT1/8	<a href="#">1809 06 11</a>	13	19.5	8	25.5	13.5	0.021
	NPT1/4	<a href="#">1809 06 14</a>	13	25.5	10	25.5	13.5	0.032
	NPT3/8	<a href="#">1809 06 18</a>	13	28	12	27	15	0.046
	NPT1/2	<a href="#">1809 06 22</a>	13	34	12	29	17	0.071
8	NPT1/8	<a href="#">1809 08 11</a>	14	22	10	28.5	14.5	0.027
	NPT1/4	<a href="#">1809 08 14</a>	14	25.5	10	28.5	14.5	0.033
10	NPT1/4	<a href="#">1809 10 14</a>	19	27.5	12	32.5	16	0.052
	NPT3/8	<a href="#">1809 10 18</a>	19	28	12	32.5	16	0.062
	NPT1/2	<a href="#">1809 10 22</a>	19	35	18	36.5	20	0.096
12	NPT1/4	<a href="#">1809 12 14</a>	22	28.5	14	34	17	0.068
	NPT3/8	<a href="#">1809 12 18</a>	22	29.5	14	34	17	0.073
	NPT1/2	<a href="#">1809 12 22</a>	22	35	18	37	20	0.104
16	NPT3/8	<a href="#">1809 16 18</a>	27	31	18	39.5	21	0.110
	NPT1/2	<a href="#">1809 16 22</a>	27	34.5	18	39.5	21	0.116

## 1820 Stud Standpipe, Male BSPT Thread

Stainless steel 316L

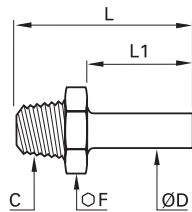

ØD	C		F	L	L1	Kg
6	R1/8	<a href="#">1820 06 10</a>	12	26.5	15	0.009
	R1/4	<a href="#">1820 06 13</a>	14	31	15	0.018
8	R1/8	<a href="#">1820 08 10</a>	12	28.5	17	0.008
	R1/4	<a href="#">1820 08 13</a>	14	33	17	0.017
10	R1/4	<a href="#">1820 10 13</a>	14	36	20	0.017
	R3/8	<a href="#">1820 10 17</a>	17	36.5	20	0.025
	R1/2	<a href="#">1820 10 21</a>	22	41	20	0.053
12	R1/4	<a href="#">1820 12 13</a>	14	36	20	0.016
	R3/8	<a href="#">1820 12 17</a>	17	36.5	20	0.022
16	R1/2	<a href="#">1820 12 21</a>	22	41	20	0.049
	R3/8	<a href="#">1820 16 17</a>	17	39.5	23	0.022
	R1/2	<a href="#">1820 16 21</a>	22	44	23	0.039

## 1820 Stud Standpipe, Male NPT Thread

Stainless steel 316L

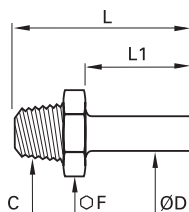

ØD	C		F	L	L1	Kg
6	NPT1/8	<a href="#">1820 06 11</a>	12	26.5	15	0.010
	NPT1/4	<a href="#">1820 06 14</a>	14	31	15	0.019
8	NPT1/8	<a href="#">1820 08 11</a>	12	28.5	17	0.009
	NPT1/4	<a href="#">1820 08 14</a>	14	33	17	0.019
10	NPT1/4	<a href="#">1820 10 14</a>	14	36	20	0.018
	NPT3/8	<a href="#">1820 10 18</a>	19	36.5	20	0.032
	NPT1/2	<a href="#">1820 10 22</a>	22	41	20	0.060
12	NPT1/4	<a href="#">1820 12 14</a>	14	36	20	0.019
	NPT3/8	<a href="#">1820 12 18</a>	19	36.5	20	0.028
	NPT1/2	<a href="#">1820 12 22</a>	22	41	20	0.053
16	NPT3/8	<a href="#">1820 16 18</a>	19	39.5	23	0.027
	NPT1/2	<a href="#">1820 16 22</a>	22	44	23	0.042

Stainless Steel Compression Fittings

# Stainless Steel Compression Fittings

## 1806 Equal Tube-to-Tube Connector

Stainless steel 316L

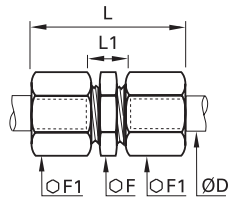

ØD		F	F1	L <sub>max</sub>	L1	Kg
6	<a href="#">1806 06 00</a>	12	13	34.5	11	0.024
8	<a href="#">1806 08 00</a>	13	14	38.5	10	0.029
10	<a href="#">1806 10 00</a>	17	19	46	13	0.066
12	<a href="#">1806 12 00</a>	19	22	47	13	0.085
16	<a href="#">1806 16 00</a>	24	27	51	13	0.136

## 1816 Equal Bulkhead Connector

Stainless steel 316L

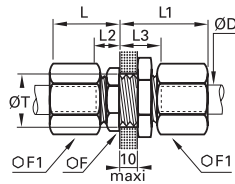

ØD		F	F1	L <sub>max</sub>	L1 <sub>max</sub>	L2	L3	ØT <sub>min</sub>	Kg
6	<a href="#">1816 06 00</a>	13	13	28	19	7.5	17	10.5	0.035
8	<a href="#">1816 08 00</a>	14	14	29	20	7	17	12.5	0.042
10	<a href="#">1816 10 00</a>	19	19	33	25	9	19	16.5	0.093
12	<a href="#">1816 12 00</a>	22	22	33	25	9	19	18.5	0.113
16	<a href="#">1816 16 00</a>	27	27	36	28	9.5	19.5	22.5	0.179

## 1802 Equal Elbow

Stainless steel 316L

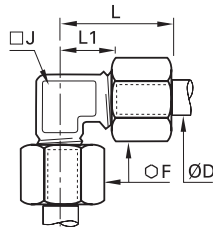

ØD		F	J	L <sub>max</sub>	L1	Kg
6	<a href="#">1802 06 00</a>	13	8	25.5	13.5	0.027
8	<a href="#">1802 08 00</a>	14	10	28.5	14.5	0.035
10	<a href="#">1802 10 00</a>	19	12	32.5	16	0.069
12	<a href="#">1802 12 00</a>	22	14	34	17	0.093
16	<a href="#">1802 16 00</a>	27	18	39.5	21	0.152

## 1804 Equal Tee

Stainless steel 316L

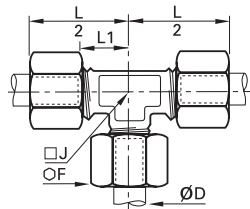

ØD		F	J	L1	L/2	Kg
6	<a href="#">1804 06 00</a>	13	8	13.5	25.5	0.039
8	<a href="#">1804 08 00</a>	14	10	14.5	28.5	0.049
10	<a href="#">1804 10 00</a>	19	12	16	32.5	0.102
12	<a href="#">1804 12 00</a>	22	14	17	34	0.132
16	<a href="#">1804 16 00</a>	27	18	21	39.5	0.215





Stainless Steel  
Compression Fittings

Compression Fittings

# Complementary Stainless Steel Fittings

## Reducers, Olives and Nuts

This innovative reducer system, using a full range of nuts and olives, enables **different diameters** of stainless steel, fluoropolymer or polymer tubes to be fitted onto **a single Parker Legris compression fitting**.

### Product Advantages

#### Efficient Solution

- Reduces envelope dimensions
- Quick and easy to assemble, whatever the diameters and tube material
- Improved stock management
- Silicone-free

#### Multiple Combinations

- A single connector for up to 3 different tube materials and sizes.
- Example:
- Advanced PE tubing 6 mm O.D.
  - stainless steel tubing 8 mm O.D.
  - fluoropolymer tubing 12 mm O.D. or braided PVC hose 10 mm I.D.
- A full range of olives and nuts to optimise all assembly operations



- Applications
- Food Process
  - Fluid Transmission
  - Pneumatics
  - Automotive Process
  - Petrochemical
  - Cooling & Heating
  - Chemical
  - Offshore Oil & Gas

### Reducer Assembly Procedure

Operation	Assembly Sequence	Assembled Fitting
<p><b>1</b></p> <p><b>Assemble the reducer</b> Place the reducer in the fitting body.</p>	<p><b>1</b></p>	
<p><b>2</b></p> <p><b>Assemble the nut and olive</b> Place the nut and then the olive onto the tube.</p>	<p><b>2</b></p>	
<p><b>3</b></p> <p><b>Assemble the nut</b> Push the tube into the fitting until it bottoms on the reducer. Tighten the nut to the recommended torque (see opposite page).</p>	<p><b>3</b></p>	

### Assembly: Barb Connectors

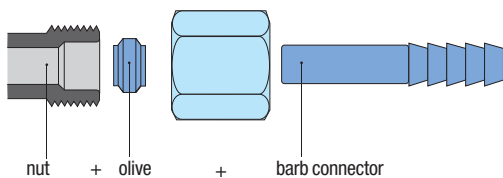

#### Regulations

- DI: 2002/95/EC (RoHS), 2011/65/EC
- DI: 97/23/EC (PED)
- RG: 1935/2004
- RG: 1907/2006 (REACH)
- DI: 94/09/EC (ATEX)
- FDA: 21 CFR 177.1550
- NACE MR0175: compatible materials
- ISO 15156-1/-2/-3: compatible materials

Our barb connector 1822 is designed to be also used with different types of hose. It is secured using the nut and olive provided with the fitting.



# Stainless Steel Compression Fittings

## 1866 3-Piece Reducer

Stainless steel 316L

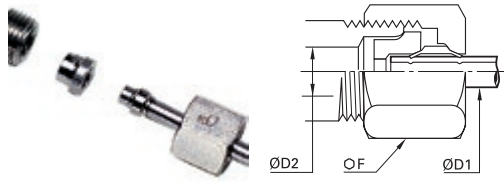

ØD1	ØD2		F	Kg
6	8	<a href="#">1866 06 08</a>	14	0.011
	10	<a href="#">1866 06 10</a>	19	0.027
	12	<a href="#">1866 06 12</a>	22	0.040
8	10	<a href="#">1866 08 10</a>	19	0.025
	12	<a href="#">1866 08 12</a>	22	0.037
10	12	<a href="#">1866 10 12</a>	27	0.071
	16	<a href="#">1866 10 16</a>	22	0.034
12	16	<a href="#">1866 12 16</a>	27	0.065
			27	0.061

## 1824 Stainless Steel Olive

Stainless steel 316L



ØD		Kg
6	<a href="#">1824 06 00</a>	0.001
8	<a href="#">1824 08 00</a>	0.001
10	<a href="#">1824 10 00</a>	0.003
12	<a href="#">1824 12 00</a>	0.004
16	<a href="#">1824 16 00</a>	0.005

## 1810 Stainless Steel Nut

Stainless steel 316L

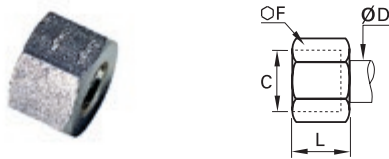

ØD	C		F	L	Kg
6	M10x1	<a href="#">1810 06 00</a>	13	11	0.007
8	M12x1	<a href="#">1810 08 00</a>	14	13	0.008
10	M16x1.5	<a href="#">1810 10 00</a>	19	15	0.017
12	M18x1.5	<a href="#">1810 12 00</a>	22	15	0.024
16	M22x1.5	<a href="#">1810 16 00</a>	27	17	0.041

## 1822 Barb Adaptor for Hose

Stainless steel 316L

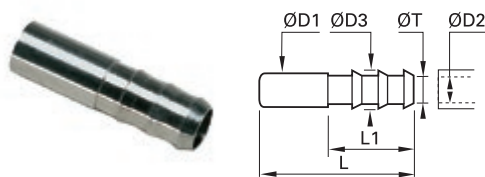

ØD1	ØD2		ØD3	L	L1	ØT min	Kg
6	7	<a href="#">1822 06 07</a>	9	37.5	22.5	6	0.006
	6	<a href="#">1822 08 06</a>	8	40	22.5	5	0.007
8	7	<a href="#">1822 08 07</a>	9	40	22.5	6	0.007
	10	<a href="#">1822 08 10</a>	12.5	40	22.5	9	0.011
10	7	<a href="#">1822 10 07</a>	9	43	22.5	6	0.009
	10	<a href="#">1822 10 10</a>	12.5	43	22.5	9	0.013
12	10	<a href="#">1822 12 10</a>	12.2	43	22.5	9	0.012
	13	<a href="#">1822 12 13</a>	15	50	29.5	13	0.016

## 1827 Stainless Steel Tube Support for Fluoropolymer Tubing

Stainless steel 316L

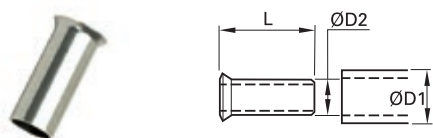

ØD1	ØD2		L	Kg
6	4	<a href="#">1827 06 00</a>	11.5	0.001
8	6	<a href="#">1827 08 00</a>	14	0.001
10	8	<a href="#">1827 10 00</a>	18	0.001
12	9	<a href="#">1827 12 09</a>	18	0.001
	10	<a href="#">1827 12 00</a>	18	0.001
16	14	<a href="#">1827 16 00</a>	18	0.002

This tube support is necessary when using fluoropolymer tubing at all temperatures compatible with the fitting/tubing assembly.



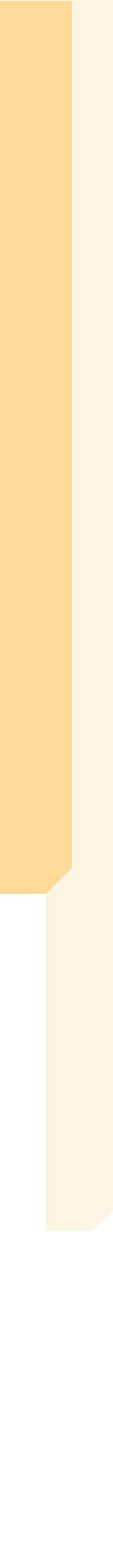

# PL Nickel-Plated Brass Spigot Fitting Range

## Stud Fittings

### Straights

**F3BPL** BSPT Page 5-43  
**F3BPL-1** BSPT Page 5-43  
**F4BPL** BSPP Page 5-43  
**F8BPL** Metric Page 5-43  
**F8BPL-1** Metric Page 5-43



### Elbows

**C3BPL** BSPT Page 5-44  
**C3BPL-1** BSPT Page 5-44  
**C4BPL** BSPP Page 5-44  
**C8BPL** Metric Page 5-44



### Tees

**R3BPL** BSPT Page 5-45  
**S3BPL** BSPT Page 5-45



## Banjo Fitting

### Banjo Fitting

**COR4BPL** BSPP Page 5-45



## Tube-to-Tube Fittings

### Straights

**HBPL** Union Page 5-46  
**HBPL-1** Union Page 5-46



### Tees

**JBPL** Union Page 5-46  
**JBPL-1** Union Page 5-46



### Bulkhead Connectors

**WBPL** Page 5-47  
**WBPL-1** Page 5-47



## Complementary Fittings

**BPLM** Nut Page 5-47  
**BPLM-M** Nut Page 5-47  
**0164** NPT/BSPP Page 5-47



# PL Nickel-Plated Brass Spigot Fittings

This range of Parker Legris has a sealing system which guarantees **excellent sealing and full flow**. PL fittings for flexible tubing are **fully re-usable**. They provide excellent compatibility with a wide variety of fluids.

## Product Advantages

### Rapid Assembly

Nut design allows for easy tightening  
Quick to assemble and disassemble  
Compatible with flexible and semi-rigid tubes (polyurethane, polyamide, polyethylene, fluoropolymers, etc.)  
Mechanical stop on the body to prevent overtightening

### Performance

Reliable direct sealing system without the use of a seal or olive  
Low pressure  
Nickel-plated for increased corrosion resistance



Food Process  
Painting  
Pneumatic Systems  
Chemical  
Welding  
Laboratories  
Railway

Applications

## Technical Characteristics

<b>Compatible Fluids</b>	Compressed air Other fluids: contact us
<b>Working Pressure</b>	Vacuum to 18 bar with BPLM-M nut Vacuum to 40 bar with BPLM nut
<b>Working Temperature</b>	-40°C to +100°C

Tightening Torque (Nm)	M5x0.8	M6x1	1/8	1/4	3/8	1/2
<b>BSPT Thread</b>			8	12	14	16
<b>BSPP Thread with "O" ring</b>			1.2	1.5	2.5	3.5
<b>BSPP Thread with metal sleeve</b>			5	8	10	12
<b>Metric Thread</b>	0.8	0.8				

Reliable performance is dependent upon the type of fluid conveyed, component materials and tubing being used.  
Guaranteed for use with a vacuum of 755 mm Hg (99% vacuum).  
For use with fire-proof tubing: please consult us.

## Installation

### Cutting the Tube



Cut the polymer tube square.

### Preparing the Connection



Slide the nut onto the tube.

### Connecting the Tube



Push the tube home into the body of the fitting.

### Final Assembly



Tighten the nut by hand (in the case of soft tubing) or using a spanner (for semi-rigid tubing) until it comes into contact with the end stop.

### Component Materials

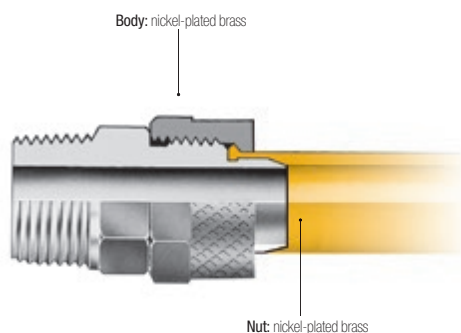



Silicone-free

# Stud Fittings

## F3BPL Stud Fitting, Male BSPT Thread

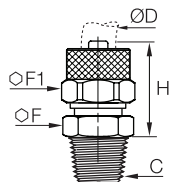
Nickel-plated brass





ØD	C		F	F1	H	Kg	
2.7x4	R1/8		F3BPL2.7/4-1/8	12	8	24	0.009
4x6	R1/8		F3BPL4/6-1/8	12	12	27.5	0.016
	R1/4		F3BPL4/6-1/4	14	12	31	0.025
6x8	R1/8		F3BPL6/8-1/8	12	14	27.5	0.019
	R3/8		F3BPL6/8-3/8	14	14	31	0.026
8x10	R1/4		F3BPL8/10-1/4	14	16	32.5	0.031
	R3/8		F3BPL8/10-3/8	17	16	33	0.043
10x12	R3/8		F3BPL10/12-3/8	17	18	34.5	0.036

Compatible with BPLM-M nut only

## F3BPL-1 Stud Fitting, Male BSPT Thread

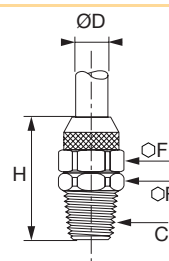
Nickel-plated brass





ØD	C		F	F1	H	Kg	
7.5x10	R1/4		F3BPL7.5/10-1/4	14	16	27.5	0.031
	R3/8		F3BPL7.5/10-3/8	17	16	28.5	0.037
11x14	R3/8		F3BPL11/14-3/8	19	22	32.5	0.058

Compatible with BPLM nut only  
Maximum working pressure: 40 bar

## F4BPL Stud Fitting, Male BSPP Thread

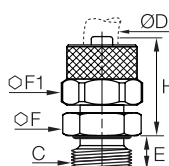
Nickel-plated brass, NBR



ØD	C		E	F	F1	H	Kg	
4x6	G1/8		F4BPL4/6-1/8	6	13	12	25.5	0.031
6x8	G1/4		F4BPL6/8-1/4	8	16	14	28	0.033

Compatible with BPLM-M nut only

## F8BPL Stud Fitting, Male Metric Thread

Nickel-plated brass, NBR

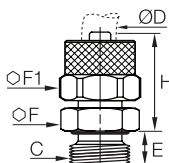

ØD	C		E	F	F1	H	Kg	
6x8	M10x1		F8BPL6/8M10	7	14	13	28	0.025

Compatible with BPLM-M nut only

## F8BPL-1 Stud Fitting, Male Metric Thread

Nickel-plated brass, copper

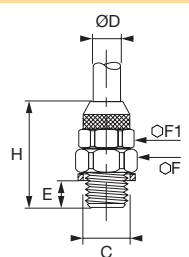

ØD	C		E	F	F1	H	Kg	
6x8	M12x1.25		F8BPL6/8M12	8	17	14	28	0.028

Compatible with BPLM nut only  
Maximum working pressure: 40 bar  
These fittings are supplied with a copper seal.

# Stud Fittings

## C3BPL Stud Elbow, Male BSPT Thread

Nickel-plated brass

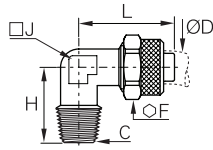

ØD	C		F	H	J	L	Kg
2.7x4	R1/8	<a href="#">C3BPL2.7/4-1/8</a>	8	17	8	19.5	0.018
	R1/8	<a href="#">C3BPL4/6-1/8</a>	12	17	8	22.5	0.022
4x6	R1/4	<a href="#">C3BPL4/6-1/4</a>	12	20	10	22.5	0.031
	R1/8	<a href="#">C3BPL6/8-1/8</a>	14	17	10	22.5	0.029
6x8	R1/4	<a href="#">C3BPL6/8-1/4</a>	14	20	10	22.5	0.031
	R3/8	<a href="#">C3BPL6/8-3/8</a>	14	22.5	11	24	0.064
8x10	R1/4	<a href="#">C3BPL8/10-1/4</a>	16	21.5	11	25.5	0.057
	R3/8	<a href="#">C3BPL8/10-3/8</a>	16	22.5	11	25.5	0.057
10x12	R3/8	<a href="#">C3BPL10/12-3/8</a>	18	24.5	14	30	0.060

Compatible with BPLM-M nut only

## C3BPL-1 Stud Elbow, Male BSPT Thread

Nickel-plated brass

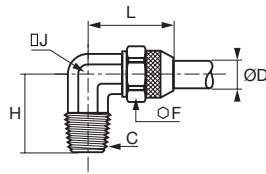

ØD	C		F	H	J	L	Kg
7.5x10	R1/4	<a href="#">C3BPL7.5/10-1/4</a>	16	22.5	12	28	0.057
	R3/8	<a href="#">C3BPL7.5/10-3/8</a>	16	23	12	28	0.058
11x14	R3/8	<a href="#">C3BPL11/14-3/8</a>	22	25	16	34	0.094

Compatible with BPLM nut only

Maximum working pressure: 40 bar

## C4BPL Stud Elbow, Male BSPP Thread

Nickel-plated brass, NBR

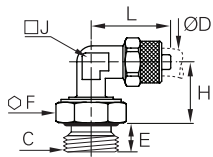

ØD	C		E	F	F1	H	J	L	Kg
6x8	G1/4	<a href="#">C4BPL6/8-1/4</a>	8	17	14	25	10	23.5	0.068

These fittings are supplied with nitrile seals.

Compatible with BPLM-M nut only

## C8BPL-1 Stud Elbow, Male Metric Thread

Nickel-plated brass, NBR

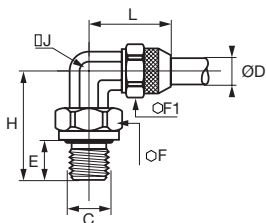

ØD	C		E	F	F1	H	J	L	Kg
6x8	M10x1	<a href="#">C8BPL6/8M10</a>	7	14	13	27	10	22	0.034
	M12x1	<a href="#">C8BPL6/8M12</a>	7	13	13	26	12	25	0.074

These fittings are supplied with nitrile seals.

Compatible with BPLM nut only





Maximum working pressure: 40 bar

# Stud Fittings

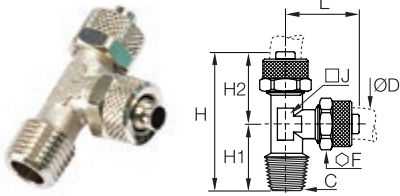
## R3BPL Stud Run Tee, Male BSPT Thread

Nickel-plated brass







	ØD	C		F	H	H1	H2	J	Kg
4x6	R1/8	R3BPL4/6-1/8		12	39.5	17	22.5	8	0.035
	R1/4	R3BPL4/6-1/4		12	43.5	21	22.5	10	0.048
6x8	R1/8	R3BPL6/8-1/8		14	40.5	18	22.5	10	0.045

Compatible with BPLM-M nut only

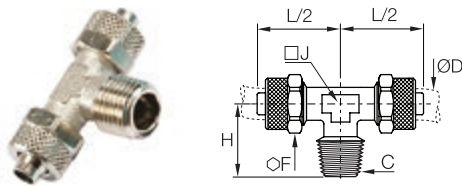
## S3BPL Stud Branch Tee, Male BSPT Thread

Nickel-plated brass







	ØD	C		F	H	J	L2	Kg
4x6	R1/8	S3BPL4/6-1/8		12	17	8	22.5	0.035
	R1/4	S3BPL4/6-1/4		12	20.5	10	22.5	0.047
6x8	R1/8	S3BPL6/8-1/8		14	17.5	10	22.5	0.046

Compatible with BPLM-M nut only

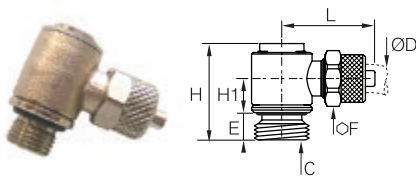
## COR4BPL Single Banjo, Male BSPP Thread

Nickel-plated brass, treated steel, NBR



	ØD	C		E	F	H	H1	L	Kg
4x6	G1/8	COR4BPL4/6-1/8		6.5	12	25.5	9	24	0.069
	G1/4	COR4BPL4/6-1/4		8	12	31.5	10	26	0.097
6x8	G1/8	COR4BPL6/8-1/8		6.5	14	25.5	9	24	0.073

These parts are supplied with peripheral seals.

The banjo bolt is made of steel.

Compatible with BPLM-M nut only

# PL Tube-to-Tube and Complementary Fittings

## HBPL Equal Tube-to-Tube Connector

Nickel-plated brass

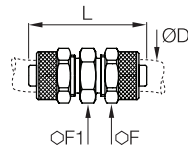

ØD		F	F1	L	Kg
2.7x4	<a href="#">HBPL2.7/4</a>	8	8	26	0.010
4x6	<a href="#">HBPL4/6</a>	12	12	34.5	0.021
6x8	<a href="#">HBPL6/8</a>	14	14	35	0.030
8x10	<a href="#">HBPL8/10</a>	14	16	38	0.043
10x12	<a href="#">HBPL10/12</a>	17	18	41	0.056

Compatible with BPLM-M nut only

## HBPL-1 Equal Tube-to-Tube Connector

Nickel-plated brass

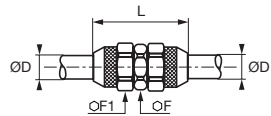

ØD		F	F1	L	Kg
11x14	<a href="#">HBPL11/14</a>	19	22	40	0,087

Compatible with BPLM nut only  
Maximum working pressure: 40 bar

## JBPL Equal Tee

Nickel-plated brass

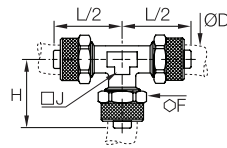

ØD		F	H	J	L2	Kg
2.7x4	<a href="#">JBPL2.7/4</a>	8	20	8	22	0.035
4x6	<a href="#">JBPL4/6</a>	12	22.5	8	22.5	0.042
6x8	<a href="#">JBPL6/8</a>	14	22.5	10	22.5	0.057
8x10	<a href="#">JBPL8/10</a>	16	25.5	11	25.5	0.085
10x12	<a href="#">JBPL10/12</a>	18	30	14	30	0.100

Compatible with BPLM-M nut only

## JBPL-1 Equal Tee

Nickel-plated brass

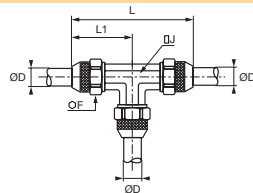

ØD		F	J	L	L1	Kg
7.5x10	<a href="#">JBPL7.5/10</a>	16	12	56	28	0.086
11x14	<a href="#">JBPL11/14</a>	22	16	68	34	0.168

Compatible with BPLM nut only  
Maximum working pressure: 40 bar



# PL Tube-to-Tube and Complementary Fittings

## WBPL

### Equal Bulkhead Connector

Nickel-plated brass

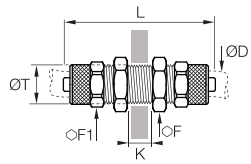

ØD		F	F1	K <sub>max</sub>	L	ØT	Kg
4x6	<a href="#">WBPL4/6</a>	14	12	10.5	48	10	0.030
6x8	<a href="#">WBPL6/8</a>	16	14	10.5	48	12	0.040
8x10	<a href="#">WBPL8/10</a>	17	16	8.5	50	14	0.057
10x12	<a href="#">WBPL10/12</a>	19	18	8.5	53	26	0.064

Compatible with BPLM-M nut only

## WBPL-1

### Equal Bulkhead Connector

Nickel-plated brass

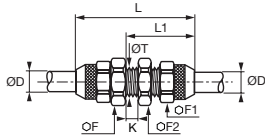

ØD		F	F1	F2	K <sub>max</sub>	L	L1	ØT	Kg
11x14	<a href="#">WBPL11/14</a>	22	22	22	5	50	28	19	0.114

Compatible with BPLM nut only  
Maximum working pressure: 40 bar.

## BPLM

### Nut

Nickel-plated brass

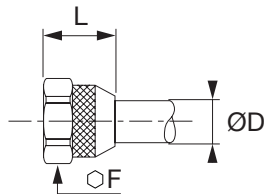

ØD	C		F	L	Kg
6x8	M11x0.75	<a href="#">BPL8M</a>	13	13	0.008
7.5x10	M13x1	<a href="#">BPL10M</a>	16	14	0.014
11x14	M18x1.5	<a href="#">BPL14M</a>	22	18	0.018

Maximum working pressure: 40 bar

## BPLM-M

### Nut

Nickel-plated brass

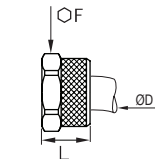

ØD	C		F	L	Kg
2.7x4	M6x0.50	<a href="#">BPL4M-1</a>	8	8	0.003
4x6	M8x0.75	<a href="#">BPL6M-1</a>	9	9	0.006
6x8	M12x1	<a href="#">BPL8M-1</a>	14	10.5	0.008
8x10	M14x1	<a href="#">BPL10M-1</a>	16	11.5	0.012
10x12	M16x1	<a href="#">BPL12M-1</a>	18	13	0.014

## 0164

### Adaptor, Male NPT/Female BSPP Thread

Nickel-plated brass

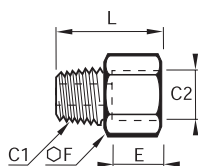

C1	C2		E	F	L	Kg
NPT1/8	G1/8	<a href="#">0164 11 10 99</a>	7.5	14	20	0.015
NPT1/4	G1/4	<a href="#">0164 14 13 99</a>	11	17	27.5	0.028
NPT3/8	G3/8	<a href="#">0164 18 17 99</a>	11.5	22	28.5	0.044

Maximum working pressure: see page 9-6, brass adaptors.





# Industrial Valves

## **Ball Valves**

LIQUIfit®

## **Needle and Butterfly Valves**

## **Axial Valves**



# Industrial Valves

## Ball Valves, Universal Series

(P. 6-8)



**Fluids:** compressed air, slightly corrosive fluids

**Materials:** nickel-plated forged brass

**Pressure:** 40 bar

**Temperature:** -40°C to +80°C

**DN:** 4 mm to 40 mm

## Ball Valves, Universal Series, Vented

(P. 6-13)



**Fluids:** compressed air, slightly corrosive fluids

**Materials:** nickel-plated forged brass

**Pressure:** 40 bar

**Temperature:** -20°C to +80°C

**DN:** 4 mm to 23 mm

## Ball Valves, Universal Series, Lockable

(P. 6-15)



**Fluids:** compressed air, slightly corrosive fluids

**Materials:** nickel-plated forged brass, galvanised steel and epoxy locking system

**Pressure:** 40 bar

**Temperature:** -40°C to +80°C

**DN:** 4 mm to 23 mm

## Ball Valves, Universal Customised Series

(P. 6-9)



**Fluids:** compressed air, many fluids

**Materials:** nickel-plated forged brass, choice of seal material (NBR, EPDM, FKM, PTFE...)

**Pressure:** 40 bar

**Temperature:** -40°C to +100°C

**DN:** 4 mm to 40 mm

## Ball Valves, Universal Light Series

(P. 6-16)



**Fluids:** compressed air, slightly corrosive fluids

**Materials:** forged brass or nickel-plated forged brass

**Pressure:** 12 bar

**Temperature:** -20°C to +80°C

**DN:** 4 mm to 13 mm

## Ball Valves, DVGW Series

(P. 6-20)



**Fluids:** compressed air, water, gas

**Materials:** nickel-plated forged brass

**Pressure:** 40 bar

**Temperature:** -50°C to +170°C

**DN:** 8 mm to 50 mm

## Ball Valves, Standard Series

(P. 6-22)



**Fluids:** compatible fluids

**Materials:** nickel or chromium-plated brass with PTFE seal

**Pressure:** 35 bar

**Temperature:** -20°C to +130°C

**DN:** 8 mm to 100 mm

## Ball Valves, Stainless Steel Series

(P. 6-28)



**Fluids:** all fluids

**Materials:** 316L stainless steel

**Pressure:** 65 bar

**Temperature:** -20°C to +150°C

**DN:** 8 mm to 50 mm

## Ball Valves, Stainless Steel Light Series

(P. 6-28)



**Fluids:** all fluids

**Materials:** 316L stainless steel

**Pressure:** 65 bar

**Temperature:** -20°C to +120°C

**DN:** 4 mm to 10 mm

# Industrial Valves

## Ball Valves, High Pressure Series

[P. 6-30]



**Fluids:** lubricants, gases  
**Materials:** zinc-plated brass  
**Pressure:** 300 bar  
**Temperature:** -15°C to +80°C  
**DN** : 7 mm to 13 mm

## Ball Valves, Mini Series

[P. 6-32]



**Fluids:** compressed air  
**Materials:** technical polymer  
**Pressure:** 10 bar  
**Temperature:** -20°C to +80°C  
**DN** : 4 mm to 12 mm

## Ball Valves, LIQUIfit®

[P. 6-34]



**Fluids:** water, beverages, CO<sub>2</sub>, inert gases  
**Materials:** polypropylene, EPDM seal  
**Pressure:** 10 bar  
**Temperature:** -15°C to +100°C  
**Ø inch:** 1/4" and 3/8"  
**Ø metric:** 6 mm to 12 mm

## Needle Valves, Brass

[P. 6-37]



**Fluids:** compressed air, industrial fluids  
**Materials:** shot-blasted forged brass, nickel-plated  
**Pressure:** 120 bar  
**Temperature:** -20°C to +100°C  
**DN** : 4 mm to 10 mm

## Needle Valves, Stainless Steel

[P. 6-41]



**Fluids:** all fluids  
**Materials:** 316L stainless steel  
**Pressure:** 400 bar  
**Temperature:** -20°C to +180°C  
**DN** : 3 mm to 6 mm

## Butterfly Valves

[P. 6-42]



**Fluids:** compressed air, abrasive fluids  
**Materials:** shot-blasted forged brass, nickel-plated  
**Pressure:** 16 bar  
**Temperature:** -20°C to +80°C  
**DN** : 6 mm to 18 mm

## Axial Valves

[P. 6-45]



**Fluids:** compressed air, industrial fluids  
**Materials:** nickel-plated brass  
**Pressure:** 10 bar  
**Temperature:** -20°C to +135°C  
**Threads :** 3/8" to 2"

# Ball Valve Range

## Universal and Universal Customised Series

### In-Line

**0402** 2/2 Page 6-10  
**0401** 2/2 Page 6-10  
**0400** 2/2 Page 6-10  
**0411** 2/2 Page 6-10  
**0414** 2/2 Page 6-10



### In-Line with Fixing Holes and Panel Mounting

**0446** 2/2 Page 6-11  
**6402** 2/2 Page 6-11  
**6401** 2/2 Page 6-11



### Right-Angled

**0472** 2/2 Page 6-11  
**0471** 2/2 Page 6-11



### In-Line, 3-Way

**0482** 3/3 Page 6-12  
**0483** 3/3 Page 6-12



### In-Line, 3-Way with Fixing Holes and Panel Mounting

**0448** 3/3 Page 6-12  
**0452** 3/2 Page 6-12



## Universal Series, Vented

### In-Line

**0489** 3/2 Page 6-13  
**0449** 3/2 Page 6-13  
**0469** 3/2 Page 6-13



### Right-Angled

**0462** 3/2 Page 6-14  
**0461** 3/2 Page 6-14



## Universal Lockable Series

### In-Line

**0432** 2/2 Page 6-15



### In-Line, Vented

**0439** 3/2 Page 6-15  
**0436** 3/2 Page 6-15  
**0437** 3/2 Page 6-15



### In-Line, 3-Way

**0438** 3/2 Page 6-15



## Universal Light Series

### In-Line

**0492** 2/2 Page 6-17  
**0491** 2/2 Page 6-17  
**0490** 2/2 Page 6-17



### In-Line, Vented

**0494** 2/2 Page 6-18



### In-Line with Square Stem

**0497** 2/2 Page 6-18  
**0496** 2/2 Page 6-18





# Ball Valve Range

## DVGW Series

### In-Line

#### BVG4-L

2/2  
Page 6-21



#### BVGT4-L

2/2  
Page 6-21



## Standard Series

### In-Line

#### 4902

2/2  
Page 6-23



#### BVGT4-C

2/2  
Page 6-23



### Compact

#### 4991

2/2  
Page 6-23



#### 4992

2/2  
Page 6-23



### In-Line, Lockable

#### BVG4-LOCK

2/2  
Page 6-24



### In-Line, Lockable, Vented

#### BVG4P-LOCK

3/2  
Page 6-24



## Stainless Steel Series

### In-Line

#### 4832

Mountable and dismountable  
2/2  
Page 6-29



#### 4812

Mountable  
2/2  
Page 6-29



#### 4810

One-Piece Construction  
2/2  
Page 6-29



#### 0465

Light Series  
2/2  
Page 6-29



## High Pressure Series

### In-Line

#### 4402

2/2  
Page 6-31



## Mini Series

### In-Line

#### 7910

2/2  
Page 6-33



#### 7911

2/2  
Page 6-33



### In-Line, Vented and Accessories

#### 7913

3/2  
Page 6-33



#### 7914

3/2  
Page 6-33



#### 7000

Page 6-33



## LIQUIfit®

### In-Line

#### 4020

2/2  
Page 6-35



#### 4020

2/2  
Page 6-35



#### 4021

2/2  
Page 6-35



#### 4023

2/2  
Page 6-35



### Right-Angled

#### 4022

2/2  
Page 6-35



#### 4024

2/2  
Page 6-35



### Accessories

#### 3130

Page 6-35



# Ball Valves, Universal Series

This range of valves has patented **seal wear compensating** technology for **reliable** and **durable** sealing, **protecting** any system whether under pressure or **vacuum**.

## Product Advantages

### Durability & Reliability

Automatic seal wear compensation for long-term reliability  
Robust, corrosion-resistant materials  
100% leak-tested in production  
Date coding to guarantee quality and traceability

### Versatility & Performance

Ideal for ensuring the performance of pneumatic circuits  
Customised valves for all special applications  
Unequalled performance under vacuum  
Smooth operation thanks to self-lubricating seals  
Large range of working pressures and temperatures  
Lever can be repositioned and replaced  
Many configurations to satisfy all system requirements



**Applications**

- Pneumatics
- Vacuum
- Transportation
- Packaging
- Textile
- Sawmill
- Rubber & Plastics

## Technical Characteristics

<b>Compatible Fluids</b>	Industrial fluids
<b>Working Pressure</b>	Vacuum to 40 bar
<b>Working Temperature</b>	-40°C to + 80°C

<b>Tightening Torques</b>	Threads	G1/8	G1/4	G3/8	G1/2	G3/4	G1
	daN.m	0.10 to 0.20	0.10 to 0.20	0.15 to 0.25	0.20 to 0.35	0.50 to 0.70	0.50 to 0.70
	Threads	G1¼	G1½	G2			
	daN.m	0.40 to 0.60	0.80 to 1.20	0.80 to 1.20			

Reliable performance is dependent upon the type of fluid conveyed, component materials and tubing being used.  
Guaranteed for use with a vacuum of 755 mm Hg (99 % vacuum).

### Component Materials

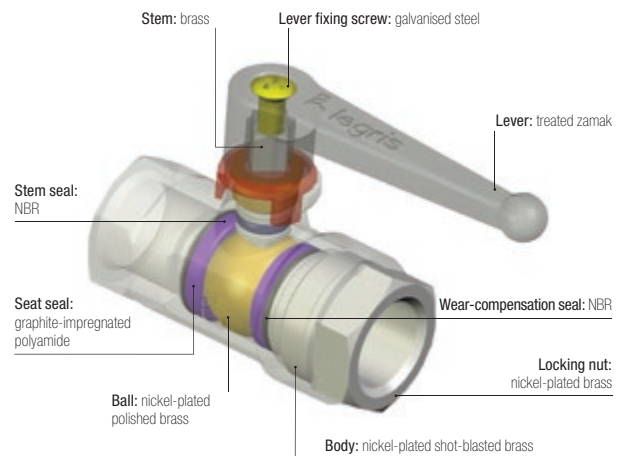

### Silicone-free

### Regulations

DI: 97/23/EC (module PED A - diameters greater than 25 mm)  
DI: 2006/42/EC (Machinery Directive)  
DI: 2002/95/EC (RoHS)  
RG: 1907/2006 (REACH)

# Universal Series

## Installation Options

### Lockable Valves

Our lockable ball valves have been developed in order to prevent potentially dangerous consequences caused by unintended operation. Lockable in different positions, this range meets international safety requirements, such as ISO 4414.

The valves are lockable:

- at one point: models 0432 and 0439
- at three points: models 0437 and 0438

### Vented Valves

To stop fluid circulation and vent the circuit, 2 venting systems are provided:

- with threaded exhaust, to allow discharge of downstream media
- with pin-hole vent, for applications with no special discharge requirement

Fluid flow direction is indicated by an arrow on the valve body.

### Mountable Valves

On steel plate:

- bulkhead fixing
- complete valve below bulkhead

On frame:

- assemble with bolts

On wooden panel:

- assemble with woodscrews

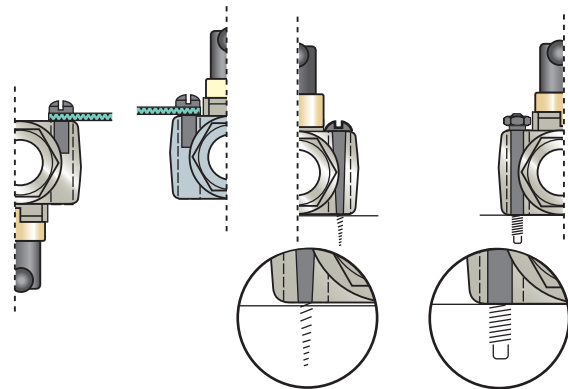

### Universal Customised Valve Series

Based on the standard components of the universal series, this range allows the valve to be adapted to specific needs. There are 6 product versions available on request.

#### Product Codes

Valve type	0402	04	10	22
0400				
0401				
0402				
...				

DN	Thread	Suffix
04 = 4 mm	10 = 1/8"	20 = blue/red
05 = 5 mm	13 = 1/4"	22 = green/blue
...	...	26 = yellow/yellow
40 = 40 mm	48 = 2"	27 = blue/green
		30 = white/red
		32 = white/green

#### Identification

Each series may be easily identified by a colour marking on the lever.

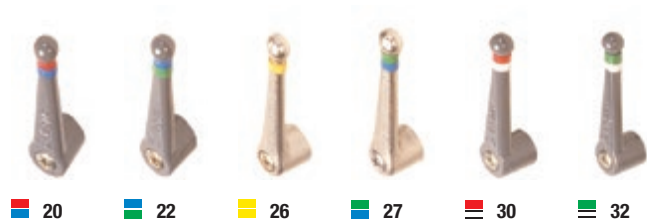

#### Suffix Specification

Identification		Body		Lever			Ball		Stem and Wear-Compensation Seals			Seat Seals			Application Examples
Suffix on the body	Colour bands on the lever	Nickel-plated brass	Chemical nickel-plated brass	Standard	Nickel-plated brass	Chemical nickel-plated brass	Nickel-plated polished brass	Chemical nickel-plated brass	EPDM	FKM	PTFE white	Rilsan: graphite-impregnated	Filled PTFE	PTFE white	
20	Blue/Red	•		•			•			•		•			Hydrocarbons
22	Green/Blue	•		•				•		•			•		Industrial fluids and high temperature
26*	Yellow/Yellow	•			•			•			•	olive		•	Corrosive liquids or high temperature and compatible for use at -50°C
27	Blue/Green		•			•		•		•			•		Industrial fluids and/or harsh environments
30**	White/Red	•		•			•		•			•			Gaseous oxygen circuits
32	White/Green	•		•			•		•				•		Water and steam circuits

\*degreased \*\*oxygen-compatible grease

A usage chart in this chapter shows which type of valve to use according to the fluid being conveyed.

# Universal Series

## 0402 2/2 In-Line Ball Valve, Female BSPP Thread



Nickel-plated brass, NBR

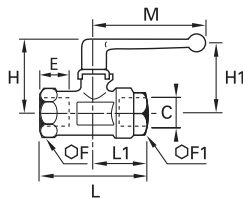

DN	C		E	F	F1	H	H1	L	L1	M	Kg
4	G1/8	<a href="#">0402 04 10</a>	8	-	14	35	29	44	25	48	0.094
7	G1/8	<a href="#">0402 07 10</a>	8	19	19	38	31	51	27	48	0.165
	G1/4	<a href="#">0402 07 13</a>	12	19	19	38	31	53	28	48	0.156
10	G3/8	<a href="#">0402 10 17</a>	12	24	24	45	43	59	31	69	0.244
13	G1/2	<a href="#">0402 13 21</a>	15	27	27	47	44	67	34	69	0.292
20	G3/4	<a href="#">0402 20 27</a>	16.5	32	38	63	54	80	39	108	0.655
23	G1	<a href="#">0402 23 34</a>	19	41	46	67	57	94	47	108	1.036
32	G1 1/4	<a href="#">0402 32 42*</a>	21.5	55	60	97	115	112	59	180	2.467
	G1 1/2	<a href="#">0402 32 49*</a>	22	55	60	97	115	120	62	180	2.340
40	G1 1/2	<a href="#">0402 40 49*</a>	22	55	55	104	-	111	55	190	2.445
	G2	<a href="#">0402 40 48*</a>	26	70	70	104	-	122	61	190	2.614

\*Models with EC marking

Maximum working pressure: 40 bar

## 0401 2/2 In-Line Ball Valve, Male/Female BSPP Thread



Nickel-plated brass, NBR

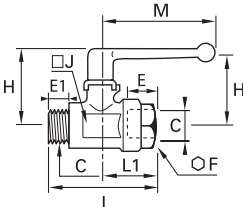

DN	C		E	E1	F	H	H1	J	L	L1	M	Kg
4	G1/8	<a href="#">0401 04 10</a>	8	7	14	35	29	14	45	25	48	0.094
5	G1/8	<a href="#">0401 05 10</a>	8	7	19	38	31	19	51	27	48	0.160
7	G1/4	<a href="#">0401 07 13</a>	12	9	19	38	31	19	52	28	48	0.150
10	G3/8	<a href="#">0401 10 17</a>	12	11	24	45	43	24	58	31	69	0.234
13	G1/2	<a href="#">0401 13 21</a>	15	12	27	47	44	27	66	34	69	0.286
18	G3/4	<a href="#">0401 18 27</a>	16.5	12	38	63	54	39	79	39	108	0.652
23	G1	<a href="#">0401 23 34</a>	19	15	46	67	57	48	91	47	108	0.952
32	G1 1/4	<a href="#">0401 32 42*</a>	21.5	18	60	97	115	55	113	59	108	2.385

\*Models with EC marking

Maximum working pressure: 40 bar

## 0400 2/2 In-Line Ball Valve, Male BSPP Thread



Nickel-plated brass, NBR

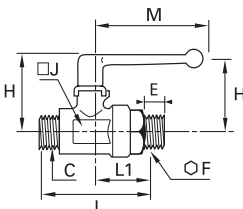

DN	C		E	F	H	H1	J	L	L1	M	Kg
4	G1/8	<a href="#">0400 04 10</a>	7	14	35	29	14	45	25	48	0.094
7	G1/4	<a href="#">0400 07 13</a>	9	19	38	31	19	60	36	48	0.166
10	G3/8	<a href="#">0400 10 17</a>	11	24	45	43	24	70	43	69	0.252
13	G1/2	<a href="#">0400 13 21</a>	12	27	47	44	27	78	45	69	0.324
18	G3/4	<a href="#">0400 18 27</a>	12	38	63	54	39	90	50	108	0.714

Maximum working pressure: 40 bar

## 0411 2/2 In-Line Ball Valve with Connections for Use with Steel Tube



Nickel-plated brass, NBR

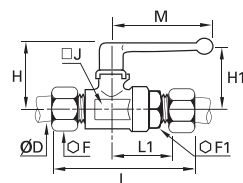

DN	ØD		F	F1	H	H1	J	L	L1	M	Kg
4	6	<a href="#">0411 04 06</a>	14	19	38	31	19	76	30	48	0.173
6	8	<a href="#">0411 06 08</a>	17	19	38	31	19	77	30	48	0.195
7	10	<a href="#">0411 07 10</a>	19	19	38	31	19	78	31	48	0.210
10	12	<a href="#">0411 10 12</a>	22	24	45	43	24	85	36	69	0.310

Maximum working pressure: 40 bar

## 0414 2/2 In-Line Ball Valve with Compression Connections



Nickel-plated brass, NBR

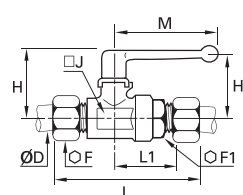

DN	ØD		F	F1	H	H1	J	L	L1	M	Kg
4	6	<a href="#">0414 04 06</a>	13	19	38	31	19	72	31	48	0.177
6	8	<a href="#">0414 06 08</a>	14	19	38	31	19	74	30	48	0.180
7	10	<a href="#">0414 07 10</a>	19	19	38	31	19	78	31	48	0.210
10	12	<a href="#">0414 10 12</a>	22	24	45	43	24	86	36	69	0.308

Maximum working pressure: 40 bar

# Universal Series

## 0446 2/2 In-Line Panel-Mountable Ball Valve, Female BSPP Thread



Nickel-plated brass, NBR

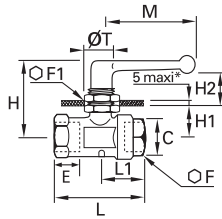

DN	C		E	F	F1	H	H1	H2	L	L1	M	ØT	Kg
4	G1/8	<a href="#">0446 04 10</a>	8	14	22	37	14	12	44	25	48	16.5	0.112
7	G1/4	<a href="#">0446 07 13</a>	12	19	24	45	19	14	53	28	48	20.5	0.188
10	G3/8	<a href="#">0446 10 17</a>	12	24	27	50	21	21	59	31	69	20.5	0.294
13	G1/2	<a href="#">0446 13 21</a>	15	27	27	51	23	21	67	34	69	20.5	0.338

Maximum working pressure: 20 bar

\*For G1/8 version, maximum panel thickness = 3 mm

## 6402 2/2 In-Line Ball Valve for Screw Fixing, Female BSPP Thread



Nickel-plated brass, NBR

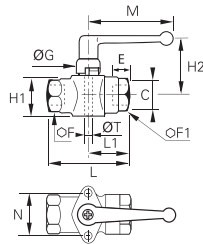

DN	C		E	F	F1	G	H1	H2	L	L1	M	N	ØT	Kg
4	G1/8	<a href="#">6402 04 10</a>	8	14	14	18	18	30	44	25	48	25	4x70	0.132
7	G1/4	<a href="#">6402 07 13</a>	12	19	19	19	24	31	53	28	48	31	5x80	0.216
10	G3/8	<a href="#">6402 10 17</a>	12	24	24	20	30	45	59	31	69	31	5x80	0.324
13	G1/2	<a href="#">6402 13 21</a>	15	27	27	20	34	47	67	34	69	34	6x100	0.404
20	G3/4	<a href="#">6402 20 27</a>	16.5	32	38	27	44	52	80	39	108	43	8x125	0.830
23	G1	<a href="#">6402 23 34</a>	19	41	46	27	53	56	94	47	108	51	8x125	1.290

Maximum working pressure: 40 bar

## 6401 2/2 In-Line Ball Valve for Screw Fixing, Male/Female BSPP Thread

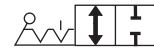

Nickel-plated brass, NBR

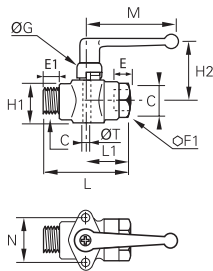

DN	C		E	E1	F	G	H1	H2	L	L1	M	N	ØT	Kg
4	G1/8	<a href="#">6401 04 10</a>	8	7	14	18	18	30	45	25	48	25	4x70	0.127
7	G1/4	<a href="#">6401 07 13</a>	12	9	19	19	24	31	52	28	48	31	5x80	0.212
10	G3/8	<a href="#">6401 10 17</a>	12	11	24	20	30	45	58	31	69	31	5x80	0.306
13	G1/2	<a href="#">6401 13 21</a>	15	12	27	20	34	47	67	34	69	34	6x100	0.394

Maximum working pressure: 40 bar

## 0472 2/2 Right-Angled Ball Valve, Female BSPP Thread

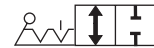

Nickel-plated brass, NBR

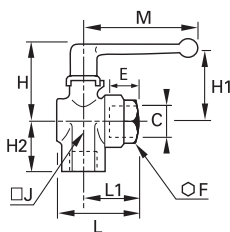

DN	C		E	F	H	H1	H2	J	L	L1	M	Kg
4	G1/8	<a href="#">0472 04 10</a>	8	14	35	29	18	14	34	25	48	0.096
6	G1/8	<a href="#">0472 06 10</a>	8	19	38	31	20	22	37	27	48	0.183
	G1/4	<a href="#">0472 06 13</a>	12	19	38	31	24	22	38	28	48	0.191
9	G3/8	<a href="#">0472 09 17</a>	12	24	45	43	27	25	46	31	69	0.260
12	G1/2	<a href="#">0472 12 21</a>	15	27	47	44	33	29	49	34	69	0.312
18	G3/4	<a href="#">0472 18 27</a>	16.5	38	59	51	40	39	60	39	108	0.704
23	G1	<a href="#">0472 23 34</a>	19	46	63	55	47	48	72	47	108	1.062

Maximum working pressure: 20 bar

## 0471 2/2 Right-Angled Ball Valve, Male/Female BSPP Thread



Nickel-plated brass, NBR

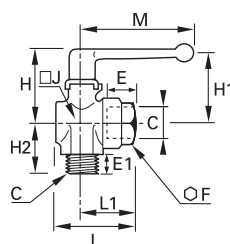

DN	C		E	E1	F	H	H1	H2	J	L	L1	M	Kg
4	G1/8	<a href="#">0471 04 10</a>	8	7	14	35	29	19	14	34	25	48	0.096
6	G1/8	<a href="#">0471 06 10</a>	8	7	19	38	31	22	22	37	27	48	0.182
	G1/4	<a href="#">0471 06 13</a>	12	9	19	38	31	25	22	38	28	48	0.187
9	G3/8	<a href="#">0471 09 17</a>	12	11	24	45	43	28	25	46	31	69	0.256
12	G1/2	<a href="#">0471 12 21</a>	15	12	27	47	44	32	29	49	34	69	0.303
18	G3/4	<a href="#">0471 18 27</a>	16.5	12	38	59	51	37	39	60	39	108	0.682
23	G1	<a href="#">0471 23 34</a>	19	15	46	63	55	44	48	72	47	108	1.020

Maximum working pressure: 20 bar

# Universal Series

## 0482 3/3 Right-Angle Ported Ball Valve, Female BSPP Thread

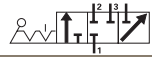

Nickel-plated brass, NBR

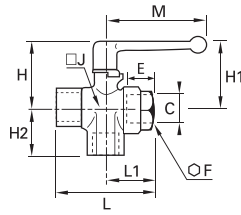

DN	C		E	F	H	H1	H2	J	L	L1	M	Kg
4	G1/8	<a href="#">0482 04 10</a>	8	14	35	29	18	14	44	25	48	0.102
6	G1/4	<a href="#">0482 06 13</a>	12	19	38	31	24	22	53	28	48	0.200
9	G3/8	<a href="#">0482 09 17</a>	12	24	45	43	27	25	59	31	69	0.284
12	G1/2	<a href="#">0482 12 21</a>	15	27	47	44	33	29	67	34	69	0.346
18	G3/4	<a href="#">0482 18 27</a>	16.5	38	59	51	40	39	80	39	108	0.742
23	G1	<a href="#">0482 23 34</a>	19	46	63	55	47	48	94	47	108	1.160

Maximum working pressure: 20 bar

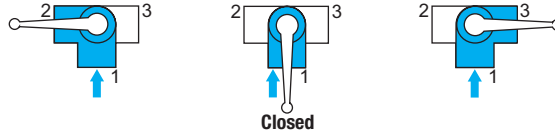

## 0483 3/3 Right-Angle Ported Ball Valve Without Closed Position, Female BSPP Thread



Nickel-plated brass, NBR

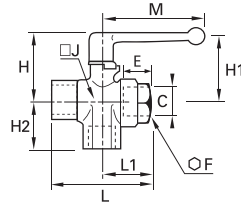

DN	C		E	F	H	H1	H2	J	L	L1	M	Kg
4	G1/8	<a href="#">0483 04 10</a>	8	14	35	29	18	14	44	25	48	0.102
6	G1/4	<a href="#">0483 06 13</a>	12	19	38	31	24	22	53	28	48	0.196
9	G3/8	<a href="#">0483 09 17</a>	12	24	45	43	27	25	59	31	69	0.278
12	G1/2	<a href="#">0483 12 21</a>	15	27	47	44	33	29	67	34	69	0.340
18	G3/4	<a href="#">0483 18 27</a>	16.5	38	59	51	40	39	80	39	108	0.716
23	G1	<a href="#">0483 23 34</a>	19	46	63	55	47	48	94	47	108	1.066

Maximum working pressure: 20 bar

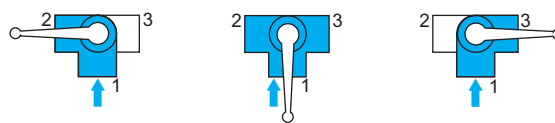

## 0448 3/3 Panel-Mountable Right-Angled Ball Valve, Female BSPP Thread



Nickel-plated brass, NBR

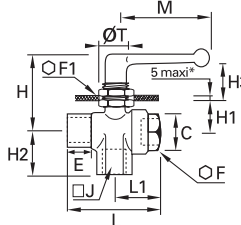

DN	C		E	F	F1	H	H1	H2	H3	J	L	L1	M	ØT	Kg
4	G1/8	<a href="#">0448 04 10*</a>	8	14	22	37	14	18	12	14	44	25	48	16.5	0.126
6	G1/4	<a href="#">0448 06 13</a>	12	19	24	45	19	24	14	22	53	28	48	20.5	0.230
9	G3/8	<a href="#">0448 09 17</a>	12	24	27	50	21	27	21	25	59	31	69	20.5	0.328
12	G1/2	<a href="#">0448 12 21</a>	15	27	27	51	23	33	21	29	67	34	69	20.5	0.392

Maximum working pressure: 20 bar

\*For G1/8 version: maximum panel thickness = 3 mm

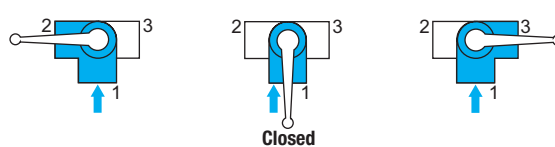

## 0452 3/2 Panel-Mountable Equal Plane Ball Valve, Female BSPP Thread



Nickel-plated brass, NBR

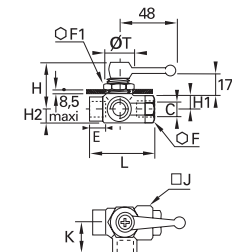

DN	C		E	F	F1	H	H1	H2	J	K	L	ØT	Kg
4	G1/8	<a href="#">0452 04 10</a>	8	14	22	39	10	8	16	18	25	19	0.130
6	G1/4	<a href="#">0452 06 13</a>	12	19	24	40	11	11	23	24	28	20	0.206

Maximum working pressure: 20 bar

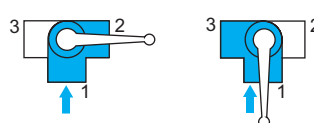

# Universal Series, Vented

## 0489 3/2 In-Line Vented Ball Valve, Female BSPP and Metric Thread



Nickel-plated brass, NBR

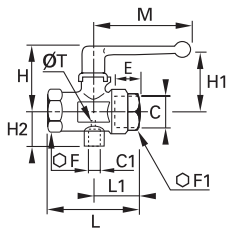

DN	C	C1		E	F	F1	H	H1	H2	L	L1	M	ØT	Kg
7	G1/4	M5x0.8	<a href="#">0489 07 13</a>	12	24	24	46	43	17	59	31	69	2	0.270
10	G3/8	M5x0.8	<a href="#">0489 10 17</a>	12	24	24	46	43	17	59	31	69	2	0.243
13	G1/2	G1/8	<a href="#">0489 13 21</a>	15	27	27	47	44	24	67	34	69	2	0.310
18	G3/4	G1/4	<a href="#">0489 18 27</a>	16.5	32	38	63	54	33	80	39	108	2.5	0.670
23	G1	G1/4	<a href="#">0489 23 34</a>	19	41	46	67	57	37	94	47	108	3	1.050

Maximum working pressure: 40 bar

## 0449 3/2 Panel-Mountable In-Line Ball Valve, Female BSPP and Metric Thread



Nickel-plated brass, NBR

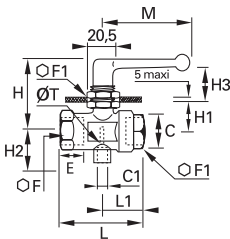

DN	C	C1		E	F	F1	H	H1	H2	H3	L	L1	M	ØT	Kg
7	G1/4	M5x0.8	<a href="#">0449 07 13</a>	12	24	27	50	20	17	21	59	31	69	2.5	0.313
10	G3/8	M5x0.8	<a href="#">0449 10 17</a>	12	24	27	50	20	17	21	59	31	69	2.5	0.291
13	G1/2	G1/8	<a href="#">0449 13 21</a>	15	27	27	52	23	24	21	67	34	69	4	0.352

Maximum working pressure: 20 bar

## 0469 3/2 In-Line Vented Ball Valve, Female BSPP Thread



Nickel-plated brass, NBR

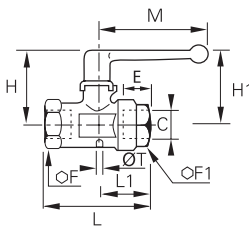

DN	C		E	F	F1	H	H1	L	L1	M	ØT	Kg
4	G1/8	<a href="#">0469 04 10</a>	8	14	14	35	29	44	25	48	1.5	0.092
7	G1/4	<a href="#">0469 07 13</a>	12	24	24	46	43	59	31	70	2	0.268
10	G3/8	<a href="#">0469 10 17</a>	12	24	24	46	43	59	31	70	2	0.246
13	G1/2	<a href="#">0469 13 21</a>	15	27	27	47	44	67	34	70	2	0.293
18	G3/4	<a href="#">0469 18 27</a>	16.5	32	38	63	54	80	39	108	2.5	0.668
23	G1	<a href="#">0469 23 34</a>	19	41	46	67	57	94	47	108	3	1.026

Maximum working pressure: 40 bar

### Operation of Vented Ball Valves

With vent connected to a tube = collection of purged media

With vent connected to a silencer = noiseless discharge to atmosphere

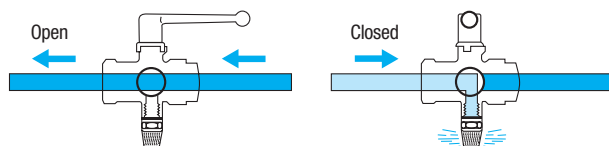
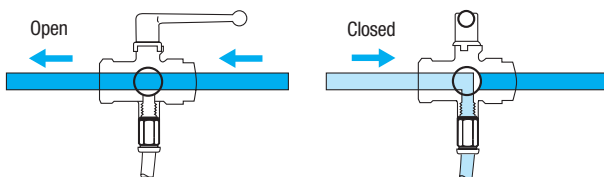

You will find our ranges of fittings, tubing and silencers in Chapters 1, 3 and 4.



# Universal Series, Vented

## 0462 3/2 Right-Angled Ball Valve with Vent, Female BSPP Thread



Nickel-plated brass, NBR

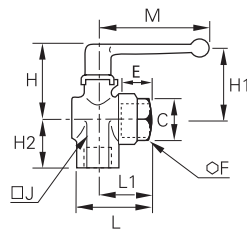

DN	C		E	F	H	H1	H2	J	L	L1	M	Kg
6	G1/8	0462 06 10	8	19	38	31	20	22	37	27	48	0.192
	G1/4	0462 06 13	12	19	38	31	24	22	38	28	48	0.185
9	G3/8	0462 09 17	12	24	45	43	27	25	46	31	69	0.261
12	G1/2	0462 12 21	15	27	47	44	33	29	49	34	69	0.311
18	G3/4	0462 18 27	16.5	38	59	51	40	39	60	39	108	0.698
23	G1	0462 23 34	19	46	63	55	47	48	72	47	108	1.066

Maximum working pressure: 20 bar

## 0461 3/2 Right-Angled Ball Valve with Vent, Male/Female BSPP Thread



Nickel-plated brass, NBR

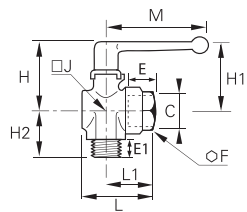

DN	C		E	E1	F	H	H1	H2	J	L	L1	M	Kg
6	G1/8	0461 06 10	8	7	19	38	31	20	22	37	27	48	0.182
	G1/4	0461 06 13	12	9	19	38	31	24	22	38	28	48	0.186
9	G3/8	0461 09 17	12	11	24	45	43	27	25	46	31	69	0.257
12	G1/2	0461 12 21	15	12	27	47	44	33	29	49	34	69	0.304
18	G3/4	0461 18 27	16.5	12	38	59	51	40	39	60	39	108	0.648

Maximum working pressure: 20 bar

### Operation of Right-Angled Vented Ball Valves

### Operation of Lockable Vented Ball Valves

With pin-hole vent = purge to atmosphere without silencer

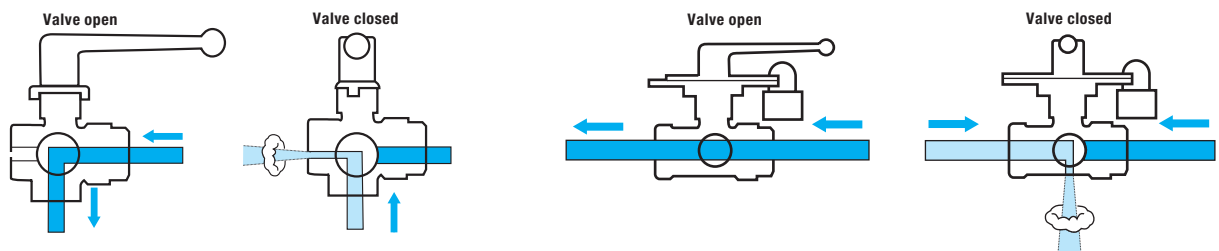

**Removable lever:** where the lever is obstructed in its movement, it can be refitted the opposite way.

### Operation of 3/2 Lockable Valves

Drilled below and square in the horizontal plane, these valves provide a connection between: either port 1 and port 2, or port 2 and port 3.

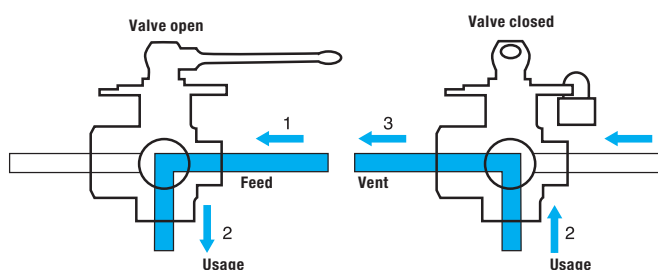

**Removable lever:** where the lever is obstructed in its movement, it can be refitted the opposite way.



# Universal Series, Lockable

## 0432 2/2 In-Line Lockable Ball Valve, Female BSPP Thread



Nickel-plated brass, NBR

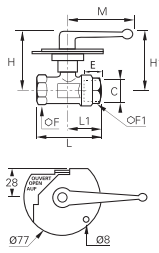

DN	C		E	F	F1	H	H1	L	L1	M	Kg
4	G1/8	<a href="#">0432 04 10</a>	8	19	19	59	54	51	27	69	0.415
7	G1/4	<a href="#">0432 07 13</a>	12	19	19	59	54	59	28	69	0.396
10	G3/8	<a href="#">0432 10 17</a>	12	24	24	60	55	59	31	69	0.460
13	G1/2	<a href="#">0432 13 21</a>	15	27	27	62	57	67	34	69	0.510
20	G3/4	<a href="#">0432 20 27</a>	16.5	32	38	66	56	80	39	108	0.800
23	G1	<a href="#">0432 23 34</a>	19	41	46	70	59	94	47	108	1.186

Maximum working pressure: 40 bar

Handle is not removable.

Fixed and mobile plates: zinc-plated steel.

## 0439 3/2 In-line Vented Lockable Ball Valve, Female BSPP Thread



Nickel-plated brass, NBR

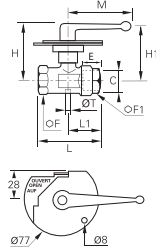

DN	C		E	F	F1	H	H1	L	L1	M	ØT	Kg
4	G1/8	<a href="#">0439 04 10</a>	8	19	19	59	54	51	27	69	2	0.410
7	G1/4	<a href="#">0439 07 13</a>	12	24	24	60	55	59	31	69	2	0.480
10	G3/8	<a href="#">0439 10 17</a>	12	24	24	60	55	59	31	69	2	0.460
13	G1/2	<a href="#">0439 13 21</a>	15	27	27	62	57	67	34	69	2	0.514
18	G3/4	<a href="#">0439 18 27</a>	16.5	32	38	66	56	80	39	108	2.5	0.810
23	G1	<a href="#">0439 23 34</a>	19	41	46	70	59	94	47	108	3	1.185

Maximum working pressure: 40 bar

Handle is not removable, locking plates are zinc-plated steel.

## 0436 3/2 In-Line Lockable Ball Valve with Threaded Exhaust Port, Female BSPP and Metric Thread



Nickel-plated brass, NBR

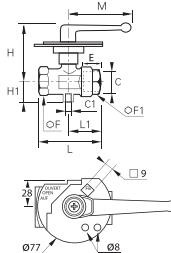

DN	C	C1		E	F	F1	H	H1	L	L1	M	Kg
10	G3/8	M5x0.8	<a href="#">0436 10 17</a>	12	24	24	60	17	60	32	69	0.475
13	G1/2	G1/8	<a href="#">0436 13 21</a>	15	27	27	60	24.5	67.5	34.5	69	0.500
18	G3/4	G1/4	<a href="#">0436 18 27</a>	16.5	32	38	69.5	33	80	39.5	108	0.850
23	G1	G1/4	<a href="#">0436 23 34</a>	19	32	38	69.5	33	80	39.5	108	1.215

Maximum working pressure: 40 bar

Handle is not removable.

Fixed and mobile plates: zinc-plated steel

## 0437 3/2 In-line Vented 3-Point Lockable Ball Valve, Female BSPP Thread



Nickel-plated brass, NBR

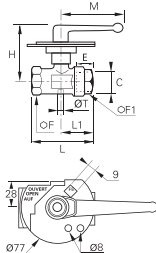

DN	C		E	F	F1	H	L	L1	M	ØT	Kg
7	G1/4	<a href="#">0437 07 13</a>	12	24	24	60	59	32	69.5	2	0.476
10	G3/8	<a href="#">0437 10 17</a>	12	24	24	60	60	32	69.5	2	0.447
13	G1/2	<a href="#">0437 13 21</a>	15	27	27	60	67.5	34.5	69.5	2	0.510
18	G3/4	<a href="#">0437 18 27</a>	16.5	32	38	69.5	80	39.5	108.5	2.5	0.820
23	G1	<a href="#">0437 23 34</a>	19	41	46	73	94.5	47.5	108.5	3	1.192

Maximum working pressure: 40 bar

Handle is not removable

Locking plates are zinc-plated steel

## 0438 3/2 Right-Angled 3-Point Lockable Ball Valve, Female BSPP Thread



Nickel-plated brass, NBR

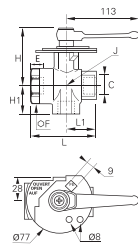

DN	C		E	F	H	H1	J	L	L1	Kg
9	G3/8	<a href="#">0438 09 17</a>	12	38	76	34	39	73	35	0.970
12	G1/2	<a href="#">0438 12 21</a>	15	38	76	37	39	78	38	0.947
18	G3/4	<a href="#">0438 18 27</a>	16.5	38	76	40	39	80	40	0.905
23	G1	<a href="#">0438 23 34</a>	19	46	80	47	48	94	47	1.295

Maximum working pressure: 20 bar

Fixed plate: zinc-plated steel, mobile plate: steel, grey epoxy-coated

Removable handle: where the handle is obstructed in its movement, it can be refitted opposite the original position.

# Ball Valves, Universal Light Series

Using the Universal Series technology, the Parker Legris light series valves offer the advantages of **compactness**, **ease of operation** and **long-term reliability**.

## Product Advantages

<b>Easy-to-Use</b>	Ease of operation due to the low friction design The short levers may be repositioned and exchanged Extremely compact Wide range of configurations
<b>Maximum Efficiency</b>	Excellent performance under vacuum Full flow Chemical nickel-plated brass with high phosphorous content for outstanding corrosion resistance Automatic seal wear compensation system
<b>Reliability</b>	Tried-and-tested technology Forged brass provides mechanical strength and long service life 100% leak-tested in production Date coding to guarantee quality and traceability



**Applications**

- Vacuum
- Transportation
- Packaging
- Textile
- Pneumatics
- Sawmills
- Rubber & Plastics

## Technical Characteristics

<b>Compatible Fluids</b>	Compressed air Other fluids: see compatibility chart at the end of this chapter
<b>Working Pressure</b>	Vacuum to 12 bar
<b>Working Temperature</b>	-20°C to +80°C

<b>Tightening Torques</b>	Threads	G1/8	G1/4	G3/8	G1/2	G3/4
	daN.m	0.10 to 0.20	0.10 to 0.20	0.15 to 0.25	0.20 to 0.35	0.50 to 0.70

Reliable performance is dependent upon the type of fluid conveyed, component materials and tubing being used.  
Guaranteed for use with a vacuum of 755 mm Hg (99% vacuum).

### Component Materials

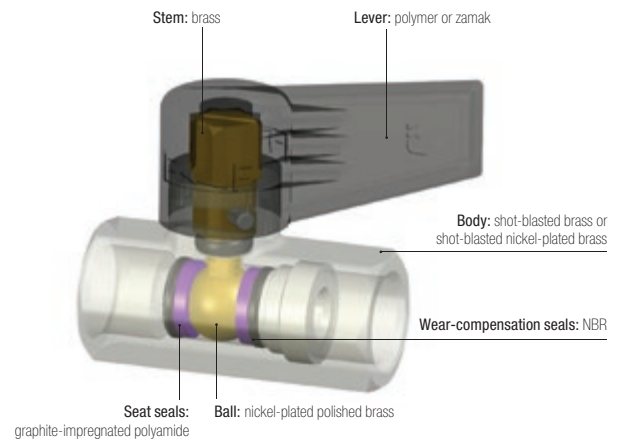

### Silicone-free

### Regulations

- DI: 97/23/EC (module PED A - diameters greater than 25 mm)
- DI: 2006/42/EC (Machinery Directive)
- DI: 2002/95/EC (RoHS)
- RG: 1907/2006 (REACH)

# Universal Light Series

## 0492

### 2/2 In-Line Ball Valve, Female BSPP Thread



Nickel-plated brass, NBR

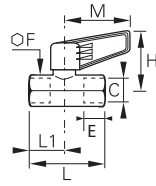

DN	C		E	F	H	L	L1	M	Kg
4	G1/4	<a href="#">0492 04 13</a>	9	17	34	39.5	17	35	0.073
7	G3/8	<a href="#">0492 07 17</a>	11	22	38	45	20	43	0.128
10	G1/2	<a href="#">0492 10 21</a>	12	24	44	54	25	50	0.162
13	G3/4	<a href="#">0492 13 27</a>	14	30	46	62	28	50	0.240

Technical polymer handle

## 0492..64

### 2/2 In-Line Ball Valve, Short Handle, Female BSPP Thread



Nickel-plated brass, NBR

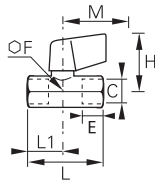

DN	C		E	F	H	L	L1	M	Kg
4	G1/4	<a href="#">0492 04 13 64</a>	9	17	36	39.5	17	25	0.090

\*Short handle in zamac

## 0491

### 2/2 In-Line Ball Valve, Male/Female BSPP Thread

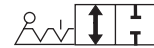

Nickel-plated brass, NBR

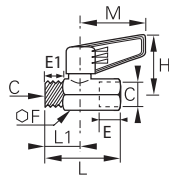

DN	C		E	E1	F	H	L	L1	M	Kg
4	G1/4	<a href="#">0491 04 13</a>	9	7	17	34	39.5	17	35	0.070
7	G3/8	<a href="#">0491 07 17</a>	11	8	22	38	45	20	43	0.124
10	G1/2	<a href="#">0491 10 21</a>	12	10	24	44	53	24	50	0.160
13	G3/4	<a href="#">0491 13 27</a>	14	12	30	46	59	25	50	0.238

Technical polymer handle

## 0491..64

### 2/2 In-Line Ball Valve, Short Handle, Male/Female BSPP Thread



Nickel-plated brass, NBR

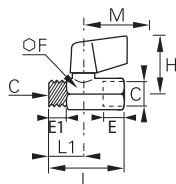

DN	C		E	E1	F	H	L	L1	M	Kg
4	G1/4	<a href="#">0491 04 13 64</a>	9	7	17	36	39.5	17	25	0.092

\*Short handle in zamac

## 0490

### 2/2 In-Line Ball Valve, Male BSPP Thread



Nickel-plated brass, NBR

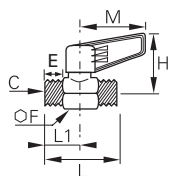

DN	C		E	F	H	L	L1	M	Kg
4	G1/4	<a href="#">0490 04 13</a>	7	17	34	39	17	35	0.070
7	G3/8	<a href="#">0490 07 17</a>	8	22	38	44	20	43	0.109
10	G1/2	<a href="#">0490 10 21</a>	10	24	44	53	24	50	0.160
13	G3/4	<a href="#">0490 13 27</a>	12	30	46	59	25	50	0.233

Technical polymer handle

# Universal Light Series

## 0494 2/2 In-Line Ball Valve, 2 Vent Plugs, Female BSPP Thread

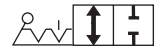

Nickel-plated brass, NBR

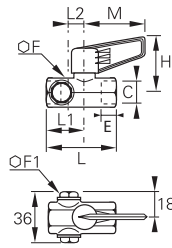

DN	C		E	F	F1	H	L	L1	L2	M	Kg
7	G3/8	<a href="#">0494 07 17</a>	11	22	16	38	60	20	15	43	0.178

Technical polymer handle

## 0497 2/2 Ball Valve, Square Stem, Female BSPP Thread

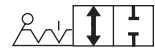

Brass, NBR

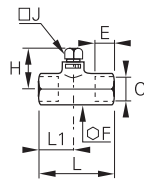

DN	C		E	F	H	J	L	L1	Kg
4	G1/4	<a href="#">0497 04 13</a>	9	17	25	7	39	17	0.063
7	G3/8	<a href="#">0497 07 17</a>	11	22	26	7	45	20	0.122
10	G1/2	<a href="#">0497 10 21</a>	12	24	29	10	54	25	0.141
13	G3/4	<a href="#">0497 13 27</a>	14	30	30	10	62	28	0.230

## 0496 2/2 Ball Valve, Square Stem, Male/Female BSPP Thread

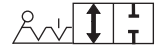

Brass, NBR

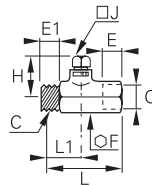

DN	C		E	E1	F	H	J	L	L1	Kg
4	G1/4	<a href="#">0496 04 13</a>	7	9	17	25	7	39	17	0.065
7	G3/8	<a href="#">0496 07 17</a>	8	11	22	26	7	45	20	0.118
10	G1/2	<a href="#">0496 10 21</a>	10	12	24	29	10	53	24	0.150
13	G3/4	<a href="#">0496 13 27</a>	12	14	30	30	10	59	28	0.222

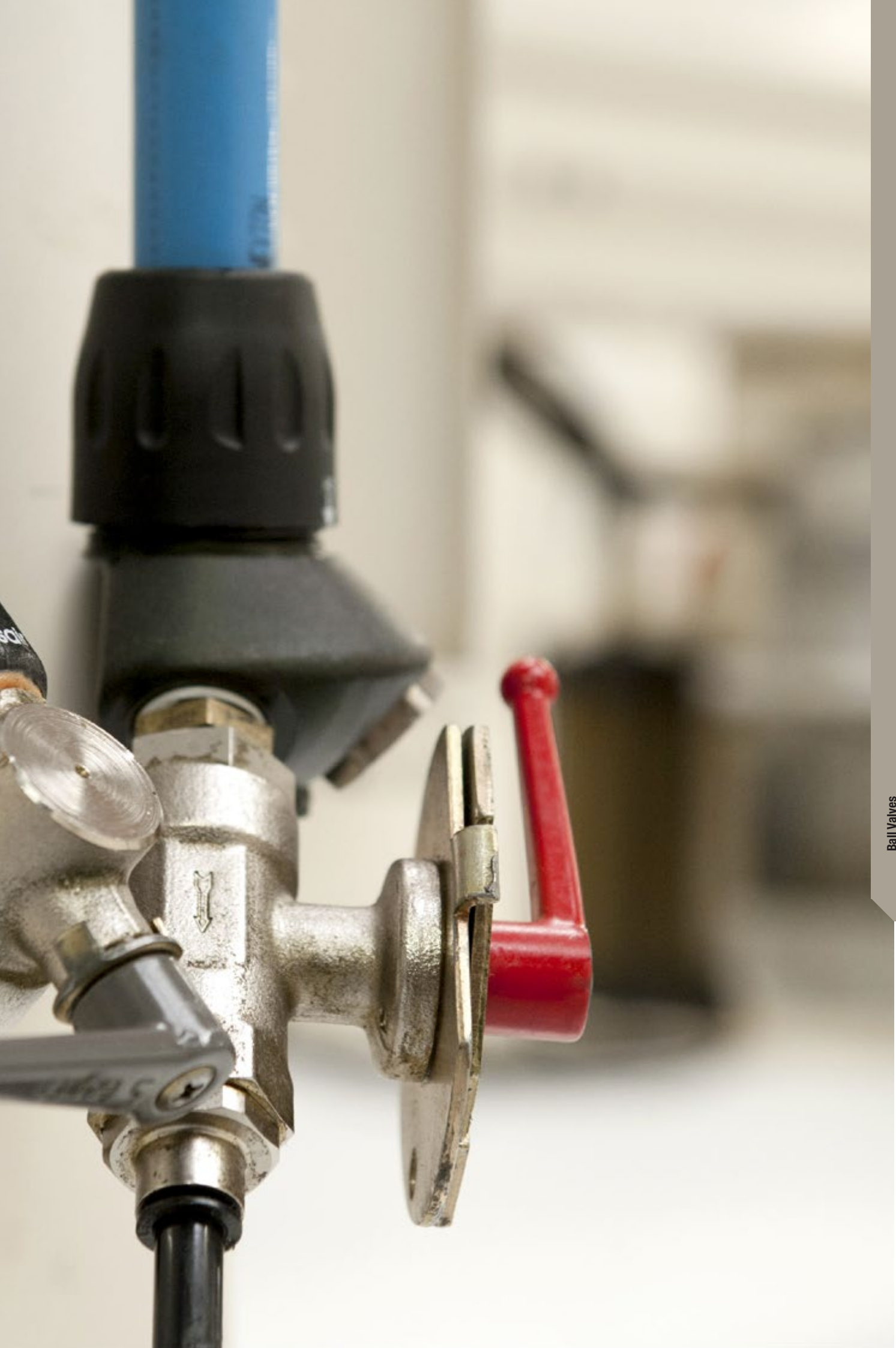

# Ball Valves, DVGW Series

The combination of long threads, a reinforced sealing system and **DVGW** certification makes this valve perfect for the **transmission of gas and water**.

## Product Advantages

### Reliability & Sealing

Stem prevented from being ejected in the event of overpressure  
Two stem seals to prevent leakage  
Date coding to guarantee quality and traceability

### Optimum Performance

Full flow minimises pressure drop  
Nickel-plated brass provides improved corrosion resistance and increased chemical compatibility  
Can be operated at very low temperatures (-50°C)

### Long Threads

Excellent fitting compatibility:  
• dimensions compliant with DIN 3357  
• BSPP threads compliant with DIN 2999/ISO 228



**Applications**  
Robotics  
Pneumatics  
Water & Gas Handling  
Machine Tools  
Textile  
Wood Industry

## Technical Characteristics

<b>Compatible Fluids</b>	Compressed air, water, gas
<b>Working Pressure</b>	1/4" to 2": 0 to 40 bar
<b>Working Temperature</b>	-50°C to +170°C

Reliable performance is dependent upon the type of fluid conveyed. Products have been tested at -50°C in static sealing and after 5 operations for a leak rate < 0,05NI/h.

### Component Materials

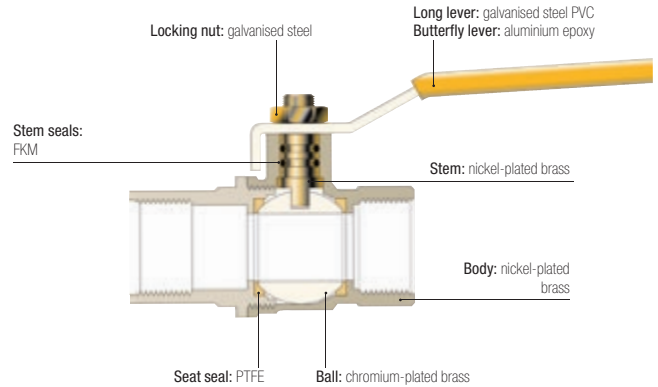

### Silicone-free

### Working Pressure and Temperature

#### Pressure - Temperature

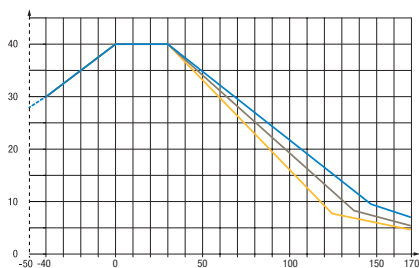

#### Pressure Drop

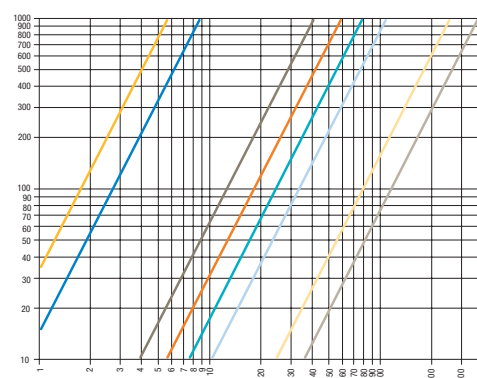

### Regulations

**Industrial**  
DI: 97/23/EC  
(PED B+D module EC 1115)  
**Water**  
DVGW: W 570-1  
DIN EN 13228  
BGA KTW  
DVGW: W270  
**Gas**  
DIN EN 33

# DVGW Series

## BVG4-L

2/2 In-Line Ball Valve, Female BSPP Thread



Nickel-plated brass

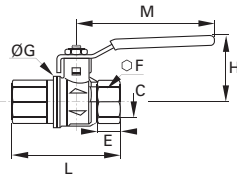

DN	C		E	F	G	H	L	M	Kg
8	G1/4	<a href="#">BVG4-1/4L</a>	12	20	25	38	50	82	0.150
10	G3/8	<a href="#">BVG4-3/8L</a>	12	20	25	38	60	82	0.150
15	G1/2	<a href="#">BVG4-1/2L</a>	15.5	25	32.5	43	75	100	0.255
20	G3/4	<a href="#">BVG4-3/4L</a>	17	32	39	50	80	120	0.390
25	G1	<a href="#">BVG4-1L</a>	21	41	47.5	54	90	120	0.590
32	G1 1/4	<a href="#">BVG4-1.1/4L</a>	23	50	59	73	110	158	0.980
40	G1 1/2	<a href="#">BVG4-1.1/2L</a>	23	55	71.5	79	120	158	1.205
50	G2	<a href="#">BVG4-2L</a>	26.5	70	86	86	140	158	1.960

## BVGT4-L

2/2 In-Line Ball Valve, Female BSPP Thread



Nickel-plated brass

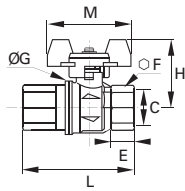

DN	C		E	F	G	H	L	M	Kg
8	G1/4	<a href="#">BVGT4-1/4L</a>	12	20	25	39	50	50	0.150
10	G3/8	<a href="#">BVGT4-3/8L</a>	12	20	25	39	60	50	0.150
15	G1/2	<a href="#">BVGT4-1/2L</a>	15.5	25	32.5	43	75	50	0.230
20	G3/4	<a href="#">BVGT4-3/4L</a>	17	32	39	47	80	60	0.350
25	G1	<a href="#">BVGT4-1L</a>	21	41	47.5	51	90	60	0.550

Compact lever



# Ball Valves, Standard Series

This range of valves with **fluoropolymer seals**, available in compact, standard and lockable series, covers many **industrial applications** for which the fluids conveyed and working temperatures require this seal material.

## Product Advantages

**Optimised Installation**

- Full fluid flow
- Long or butterfly lever
- Corrosion resistance
- A lockable version for operational safety
- Good value/performance ratio

**Wide Compatibility**

- Numerous compatible fluids
- Can be used for low and medium pressure applications
- Surface treatment for corrosion protection



**Applications**

- Machine Tool
- Agricultural Machinery
- Textile
- Pneumatics
- Plumbing
- Air Conditioning
- Heating

## Technical Characteristics

Model	Standard and Lockable Series	Compact Series
<b>Compatible Fluids</b>	Compressed air, gas, water, water vapour, oil and all fluids compatible with the component materials	
<b>Working Pressure</b>	0 to 30 bar	0 to 35 bar
<b>Working Temperature</b>	-20°C to +130°C	-10°C to +90°C

Reliable performance is dependent upon the type of fluid conveyed.

### Component Materials

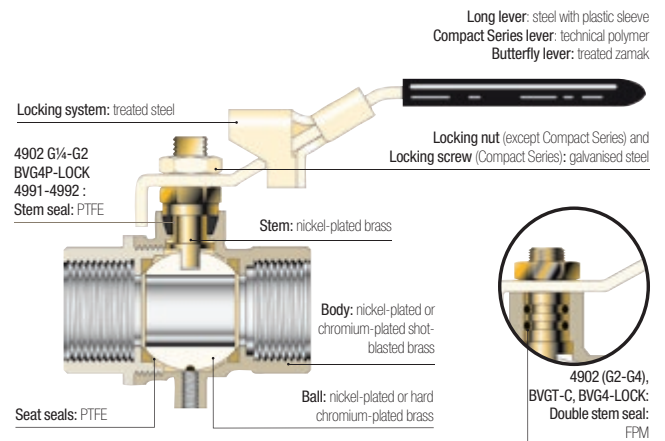

### Silicone-free

### Regulations

**Industrial**

DI: 97/23/EC (module PED A - EC diameters greater than 25 mm)

DI: Machinery Directive 2006/42/EC

DI: 2002/95/EC (RoHS)

RG: 1907/2006 (REACH)

DI: 89/392/EC



# Standard Series

## 4902

### 2/2 Standard In-Line Ball Valve, Female BSPP Thread

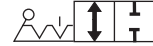

Nickel-plated brass, PTFE

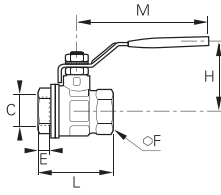

DN	C		E	F	H	L	M	Kg
10	G1/4	<a href="#">4902 10 13</a>	11	20	43	51.5	98	0.154
	G3/8	<a href="#">4902 10 17</a>	11	20	43	51.5	98	0.138
15	G1/2	<a href="#">4902 15 21</a>	13.5	25	47	55	98	0.204
20	G3/4	<a href="#">4902 20 27</a>	12.5	31	58	57.5	122	0.322
25	G1	<a href="#">4902 25 34</a>	15	38	60	69.5	122	0.468
32	G1 1/4	<a href="#">4902 32 42*</a>	17	48	77	81.5	153	0.794
40	G1 1/2	<a href="#">4902 40 49*</a>	18	54	83	95	153	1.082
50	G2	<a href="#">4902 50 48*</a>	22	66	95	113	162	1.787
65	G2 1/2	<a href="#">4902 65 47*</a>	22	85	132	136	255	4.500
80	G3	<a href="#">4902 80 46*</a>	25	99	140	157	255	5.840
100	G4	<a href="#">4902 01 45*</a>	29	125	154	191	255	9.040

\*Models with EC marking

Model from 2 1/2": double stem seal in FPM

Working temperature: -40°C to +170°C (en pointe)

## 4991

### 2/2 Standard Compact In-Line Ball Valve, Male/Female BSPP Thread

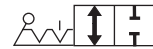

Chromium-plated brass, PTFE

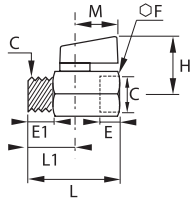

DN	C		E	E1	F	H	L	L1	M	Kg
6	G1/8	<a href="#">4991 00 10</a>	10	10	21	30	41.5	10	24	0.089
	G1/4	<a href="#">4991 00 13</a>	11	11	21	30	41.5	11	24	0.082
8	G3/8	<a href="#">4991 00 17</a>	11	11	21	30	41.5	10.5	24	0.087
	G1/2	<a href="#">4991 00 21</a>	13	13	25	32	49	12.5	24	0.134

## 4992

### 2/2 Standard Compact In-Line Ball Valve, Female BSPP Thread

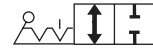

Chromium-plated brass, PTFE

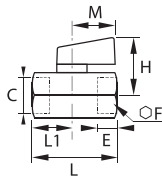

DN	C		E	F	H	L	L1	M	Kg
6	G1/8	<a href="#">4992 00 10</a>	10	21	30	41.5	10	24	0.110
	G1/4	<a href="#">4992 00 13</a>	11	21	30	41.5	11	24	0.106
8	G3/8	<a href="#">4992 00 17</a>	11	21	30	41.5	10.5	24	0.094
	G1/2	<a href="#">4992 00 21</a>	13	25	32	49	12.5	24	0.142

## BVGT4-C

### 2/2 Standard In-Line Ball Valve, Female BSPP Thread



Nickel-plated brass

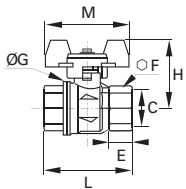

DN	C		E	F	G	H	L	M	Kg
8	G1/4	<a href="#">BVGT4-1/4C</a>	9	20	25	40	39	50	0.130
10	G3/8	<a href="#">BVGT4-3/8C</a>	9	20	25	40	39	50	0.120
15	G1/2	<a href="#">BVGT4-1/2C</a>	11	25	32.5	44	50	50	0.180
20	G3/4	<a href="#">BVGT4-3/4C</a>	12	31	39	49	54	50	0.265
25	G1	<a href="#">BVGT4-1C</a>	14	38	47.5	53	67	50	0.390

Compact lever

# Standard Series

## BVG4-LOCK

2/2 In-Line Lockable Ball Valve, Female BSPP Thread

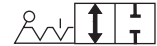

Nickel-plated brass

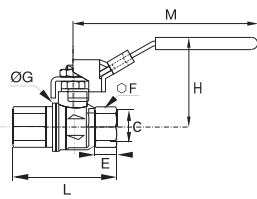

DN	C		E	F	ØG	H	L	M	Kg
8	G1/4	<a href="#">BVG4-1/4LOCK</a>	12	20	25	38	50	82	0.150
10	G3/8	<a href="#">BVG4-3/8LOCK</a>	12	20	25	38	60	82	0.150
15	G1/2	<a href="#">BVG4-1/2LOCK</a>	15.5	25	32.5	43	75	100	0.255
20	G3/4	<a href="#">BVG4-3/4LOCK</a>	17	32	39	50	80	120	0.390
25	G1	<a href="#">BVG4-1LOCK</a>	21	41	47.5	54	90	120	0.590

Double stem seal in FPM  
Working temperature: -40°C to +170°C

## BVG4P-LOCK

3/2 In-Line Lockable Vented Ball Valve, Female BSPP Thread



Nickel-plated brass

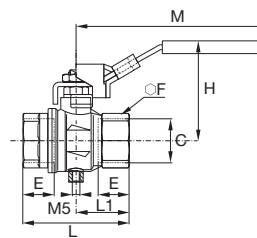

DN	C		E	F	H	L	L1	M	Kg
8	G1/4	<a href="#">BVG4P-1/4LOCK</a>	12	20	47.5	45	22.5	96	0.155
10	G3/8	<a href="#">BVG4P-3/8LOCK</a>	12	20	47.5	45	22.5	96	0.172
15	G1/2	<a href="#">BVG4P-1/2LOCK</a>	15.5	25	52	59	29.5	96	0.239
20	G3/4	<a href="#">BVG4P-3/4LOCK</a>	17	31	59.5	64	32	117	0.371
25	G1	<a href="#">BVG4P-1LOCK</a>	21	40	63.5	81	40.5	117	0.581

Working pressure: 14 bar  
Working temperature: -10°C to +100°C

# Ball Valves: Usage Chart

The chart below shows the compatibility between valves and fluids along with their pressure and temperature characteristics.

Certain models have a maximum working pressure which differs from that given in this table. In this case, the pressure is shown in the heading for the model number in question.

N.B.: Above 32 mm or 1¼" diameters, divide the maximum pressure by 2.

If the fluid you are using is not shown in this chart, please contact us.

Chemical Description	Maximum Pressure (bar)	Temperature °C		Universal and Light Series	Standard Series	DVGW series	Customised Series							
		Min.	Max.				20	22	26	27	30	32		
"Aromatic" hydrocarbons	20	-20	+60					●						
Acetone and other ketones	20	-20	+60											●
Acetophenone	20	-20	+60											●
Acetylene - Acetone	20	-20	+60											●
Acetylene (gas)	20	-20	+60	●	●	●								
Alcohol (100%)	20	-20	Boiling											●
Aluminium (liquid suspension, thick)	40	-20	+90	●	●	●								
Amyl alcohol	20	-20	Boiling											●
Animal fats, greases	20	+5	+200		●	●			●					
Antifreeze or glycol (diluted)	40	-20	+40	●	●	●								
Argon (gas) Ar	20	-20	+60	●	●	●								
Barium - Hydroxide	20	-20	+40											●
Benzaldehyde	20	-20	+60											●
Benzene	20	-20	+60					●						
Benzyl alcohol	20	-20	Boiling					●						
Borax (pastes or solutions)	20	-20	+60											●
Brake fluids (automobile)	20	-20	+90											●
Bromochlorotrifluorethane	20	-20	+60		●	●			●					
Butadiene (hydrocarbon)	20	-20	+60									●		
Butane	20	-20	+60	●	●	●								
Butanol	20	-20	Boiling					●						
Butyl alcohol	20	-20	Boiling					●						
Butylene (hydrocarbon)	20	-20	+60					●						
Carbon dioxide gas CO <sub>2</sub>	40	-20	+60	●	●									
Castor oil	40	-20	+90	●	●									
Compressed air	20	-25	+180	●	●	●	●	●	●	●	●	●	●	●
Creosotes	20	-20	+60									●		
Cresols	20	-20	+60									●		
Crude oil	20	-20	+40				●							
Cutting oil	40	-20	+90	●	●									
Decalin (hydrocarbon, solvent)	20	-20	+60									●		
Detergents (solutions)	20	-20	+100											●
Diacetone alcohol	20	-20	Boiling											●
Diesel oils	40	-20	+90	●	●									
Di-Esters	20	-20	+90					●						
Di-Isobutylene	20	-20	+60									●		
Di-Pentane	20	-20	+60					●						

The above recommendations are given in good faith. However, since each application is different, it is advisable to undertake tests in actual working conditions.

# Ball Valves: Usage Chart

Chemical Description	Max. Pressure (bar)	Temperature °C		Universal and Light Series	Standard Series	DVGW Series	Customised Series						
		Min.	Max.				20	22	26	27	30	32	
Di-Pentene (solvents, varnish)	20	-20	+60					●					
Di-Phenyl-Oxide (thin detergents)	20	-20	+60								●		
Distilled water	40		+90	●	●	●							
Edible fats	20	+5	+200		●					●			
Edible oils	20	+5	+200		●					●			
Erytrene (see Butadiene)	20	-20	+60								●		
Ethane (gas) CH <sub>2</sub> CH <sub>3</sub>	20	-20	+60	●	●								
Ethane (hydrocarbon gas)	20	-20	+60								●		
Ethyl alcohol	20	-20	+60										●
Ethylene glycol (antifreeze) - see Glycols	20	-20	+120										●
Fatty alcohols	20	-20	Boiling					●					
Fuel oils	40	-20	+40	●	●	●							
Fuels-Diesels	40	-20	+40	●	●								
Gaseous oxygen (ambient air)	20	-20	+40										●
Glycerine	20	-20	+40	●	●								
Glycol (for antifreeze, lubricants)	40	-20	+40	●	●								
Graphite in suspension in water, oils and greases	40	-20	+90	●	●								
Greases (from petroleum)	40	-20	+90	●	●								
Helium (gas)	20	-20	+60										●
Heptanal	20	-20	+50	●	●								
Hexane (solvent)	20	-20	+60										●
Hydraulic oils (petroleum-based)	40	-20	+90	●	●								
Hydrogen (gas)	20	-20	+60										●
Inks	20	-20	+60									●	
Insecticides	20	0	+40	●	●	●							
Iso-Butane (aliphatic hydrocarbon)	20	-20	+60									●	
Iso-Octane	20	-20	+60									●	
Isopropyl alcohol	20	-20	Boiling										●
Krypton (gas) Kr	20	-20	+60	●	●	●							
Light water	40		+80	●	●	●							
Lighting gas	20	-20	+40			●							
Methane (gas) CH <sub>4</sub>	20	-20	+60	●	●	●							
Methanol	20	-20	Boiling										●
Methyl alcohol	20	-20	Boiling										●
Methylated spirit	40	-20	+40	●	●	●							
Mineral oils	40	-20	+90	●	●								
Natural gas	20	-20	+40			●							
Natural waxes (vegetable, beeswax, carnauba, Chinese, lignite)	40	-20	+90									●	
Neatsfoot oil	40	-20	+90	●	●	●							
Neon (Gas) Ne	20	-20	+60	●	●	●							
Nitrogen (gas) N <sup>2</sup>	40	-20	+90	●	●	●							
Oil (petroleum-based) and water emulsions	40	-20	+90	●	●	●							

The above recommendations are given in good faith. However, since each application is different, it is advisable to undertake tests in actual working conditions.



# Ball Valves, Stainless Steel Series

**Stainless steel** series ball valves can withstand **corrosive fluids** and **environments**.

With full flow, high pressure and temperature capabilities, these valves are suitable for many applications.

## Product Advantages

**Reliability**

- Full flow
- Excellent chemical compatibility
- High resistance to pressure/temperature
- Light series version: 100% leak-tested in production, date coding to guarantee quality and traceability

**Versatility**

Three in-line versions:

- One-piece: cannot be disassembled
- 3-piece: easily disassembled for maintenance and cleaning
- Light Series: for maximum compactness

Fixing plate: 4812 and 4832

- Through-bulkhead fitting
- Pneumatic or electronic actuation (ISO 5211 standard)



**Applications**

- Food Process
- Aviation
- Chemical
- Semi-Conductors
- Medical
- Petrochemical
- Laboratories
- Pharmaceutical

## Technical Characteristics

Compatible Fluids	Type 4810, 4812 and 4832	Type 0465
	All fluids	All fluids
Working Pressure	0 to 65 bar	Vacuum to 20 bar
Working Temperature	-20°C to +150°C	-20°C to +120°C

Reliable performance is dependent upon the type of fluid conveyed, component materials and tubing being used. Guaranteed for use with a vacuum of 755 mm Hg (99% vacuum).

### Component Materials

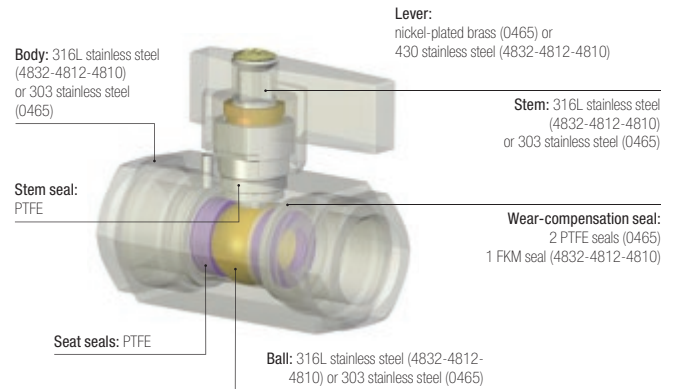

### Pressure and Temperature Resistance

#### Version 4810, 4812 and 4832

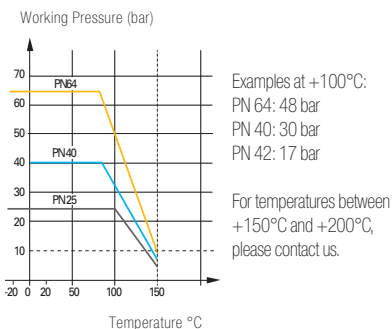

#### Version 0465

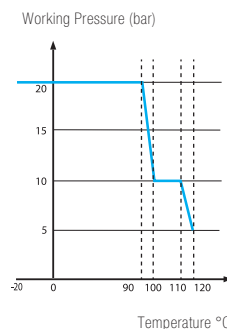

### Regulations

#### Industrial

**DI:** 97/23/EC (module PED A - EC diameters greater than 25 mm)  
**DI:** Machinery Directive 2006/42/EC  
**DI:** 2002/95/EC (RoHS)  
**RG:** 1907/2006 (REACH)  
**DI:** 89/392/EC

# Stainless Steel Series

## 4832 2/2 In-Line 3-Piece Ball Valve with Fixing Plate, Female BSPP Thread



Stainless steel 316L, PTFE

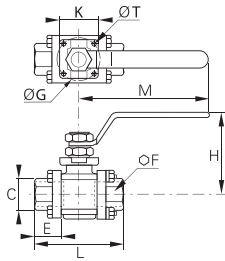

DN	C		E	F	G	H	K	L	M	ØT	Kg
10	G1/4	<a href="#">4832 10 13</a>	18	22	36	50	36	57	110.5	5.5	0.272
	G3/8	<a href="#">4832 10 17</a>	18	22	36	50	36	57	110.5	5.5	0.400
15	G1/2	<a href="#">4832 15 21</a>	20.5	27	36	64	36	65	131.5	6	0.442
20	G3/4	<a href="#">4832 20 27</a>	22.5	32	42	68	42	76	131.5	5.5	0.568
25	G1	<a href="#">4832 25 34</a>	27	41	42	78.5	42	92	174.5	6	1.035
32	G1 1/4	<a href="#">4832 32 42*</a>	30	50	42	83.5	42	106.5	174.5	5.5	1.530
40	G1 1/2	<a href="#">4832 40 49*</a>	31	55	50	100	50	116	250.5	6.5	2.146
50	G2	<a href="#">4832 50 48*</a>	36	70	50	107	50	136	250.5	6.5	3.140

\*Models with EC marking

## 4812 2/2 In-Line Ball Valve with Fixing Plate, Female BSPP Thread

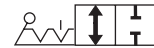

Stainless steel 316L, PTFE

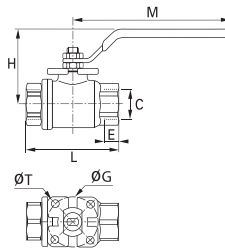

DN	C		E	G	H	L	M	ØT	Kg
10	G1/4	<a href="#">4812 10 13</a>	10	36	50	55	110	5.5	0.263
	G3/8	<a href="#">4812 10 17</a>	11	36	50	55	110	5.5	0.254
15	G1/2	<a href="#">4812 15 21</a>	15	36	53	66	110	5.5	0.336
20	G3/4	<a href="#">4812 20 27</a>	16	42	67	79	130	5.5	0.574
25	G1	<a href="#">4812 25 34</a>	19	42	79	93	175	5.5	1.000
32	G1 1/4	<a href="#">4812 32 42*</a>	21	42	83	100	175	5.5	1.337
40	G1 1/2	<a href="#">4812 40 49*</a>	21	50	100	110	250	5.5	2.214
50	G2	<a href="#">4812 50 48*</a>	26	70	107	131	250	8.5	3.262

\*Models with EC marking

## 4810 2/2 In-Line Ball Valve, Female BSPP Thread

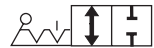

Stainless steel 316L, PTFE

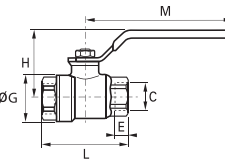

DN	C		E	G	H	L	M	Kg
8	G1/4	<a href="#">4810 08 13</a>	10	30	44.5	53.5	110.5	0.205
10	G3/8	<a href="#">4810 10 17</a>	10	30	44.5	53.5	110.5	0.194
15	G1/2	<a href="#">4810 15 21</a>	13	32.5	47	60	110.5	0.245
20	G3/4	<a href="#">4810 20 27</a>	14	40	54.5	70	131.5	0.420
25	G1	<a href="#">4810 25 34</a>	17	49	58.5	79	131.5	0.648

Threads conform to ISO 228-1

## 0465 2/2 In-Line Light Series Ball Valve, Female BSPP Thread

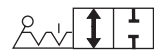

Stainless steel 303, PTFE

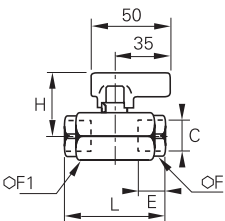

DN	C		E	F	F1	H	L	Kg
4	G1/4	<a href="#">0465 04 13</a>	13	19	24	36	50	0.226
7	G3/8	<a href="#">0465 07 17</a>	13	24	27	39	55	0.278
10	G1/2	<a href="#">0465 10 21</a>	16	27	30	40	62	0.322

Silicone-free

# Ball Valves, High Pressure Series

These valves are suitable for **applications** with pressures **up to 300 bar**.

High performance materials and quality manufacturing allow for a wide range of operating pressures and temperatures.

## Product Advantages

### High Pressure & Safety

Good sealing at low and high pressure  
Robust design with secure, non-removable inlet and outlet ports  
Forged brass providing excellent long-term strength under severe conditions of use  
100% leak-tested in production  
Date coding to guarantee quality and traceability

### Easy-to-Use

Fixing screws for through-bulkhead mounting  
The lever may be repositioned or replaced with a handwheel  
Low operating torque



Automotive Process  
Foundry  
Forming  
Machine Tools  
Textile  
Spectacle-Making Industry  
Turbines  
Deep-Sea Diving

**Applications**

## Technical Characteristics

<b>Compatible Fluids</b>	Compressed air
<b>Working Pressure</b>	Vacuum to 300 bar
<b>Working Temperature</b>	-15°C to +80°C

Reliable performance is dependent upon the type of fluid conveyed, component materials and tubing being used.  
Guaranteed for use with a vacuum of 755 mm Hg (99% vacuum).

### Component Materials

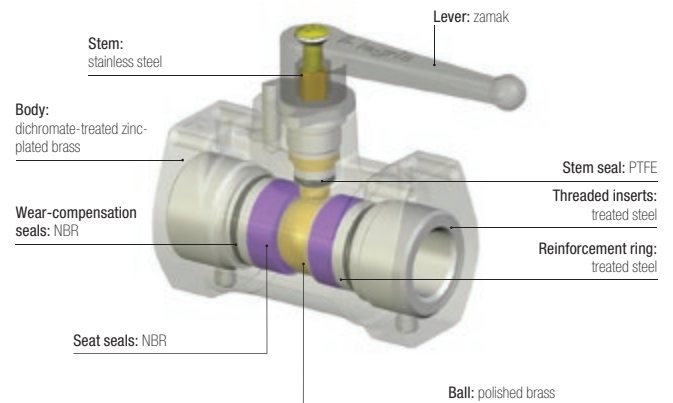

### Silicone-free

### Regulations

DI: 97/23/EC (module PED A - diameters greater than 25 mm)  
DI: 2006/42/EC (Machinery Directive)  
DI: 2002/95/EC (RoHS)  
RG: 1907/2006 (REACH)

## Installation Options

### Bulkhead Mounting

Through bulkhead with screws

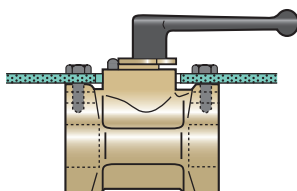

### Surface Mounting

With brackets and screws

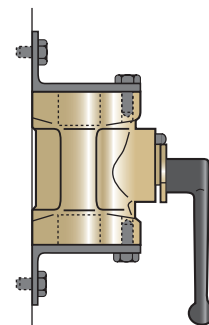



# High Pressure Series

**4402**

2/2 In-Line High Pressure Ball Valve, Female BSPP Thread

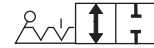

Treated brass, NBR

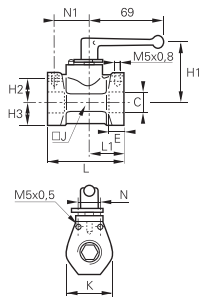

DN	C		E	H1	H2	H3	J	K	L	L1	N	N1	Kg
7	G1/4	<b>4402 07 13</b>	12	50	13	15	30	30	58	25	15	20	0.402
10	G3/8	<b>4402 10 17</b>	12	54	23	19	36	39	72	36	20	30	0.722
13	G1/2	<b>4402 13 21</b>	15	56	23	21	40	42	79	36	20	30	0.870

# Ball Valves, Mini Series

With their **push-in connections**, these polymer lightweight ball valves allow for a significant reduction in installation time while offering **full flow capability** and **compact dimensions**.

## Product Advantages

### Optimum Solution

- Full flow
- Marked with the pneumatic symbol for identification of its function
- Lightweight and compact
- Extremely compact, easy-to-operate lever
- Lever with screwdriver slot to facilitate operation
- Designed for polymer tubing with no tube preparation
- Can be mounted on a wall or adjacent using staples

### Proven Technology

- LF 3000® push-in connection, excellent static and dynamic sealing
- High-strength polyamide
- Excellent long-term performance
- Automatic seal wear compensation for long-term reliability
- 100% leak-tested in production
- Date coding to guarantee quality and traceability



**Applications**

- Robotics
- Vacuum
- Semi-Conductors
- Packaging
- Textile
- Pneumatics

## Technical Characteristics

<b>Compatible Fluids</b>	Compressed air			
<b>Working Pressure</b>	Vacuum to 10 bar			
<b>Working Temperature</b>	-20°C to +80°C			

<b>Tightening Torques</b>	Threads	G1/8	G1/4	G3/8	G1/2
	daN.m	0.8	1.2	3	3.5

Reliable performance is dependent upon the type of fluid conveyed, component materials and tubing being used.  
Guaranteed for use with a vacuum of 755 mm Hg (99 % vacuum).

### Component Materials

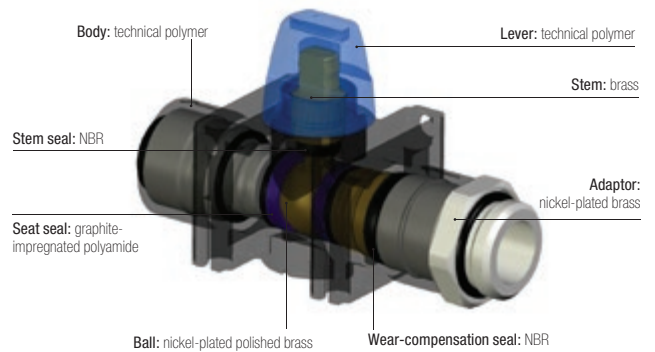

### Silicone-free

## Operation

### Vented Valve, Open Position

3/2 model with vent

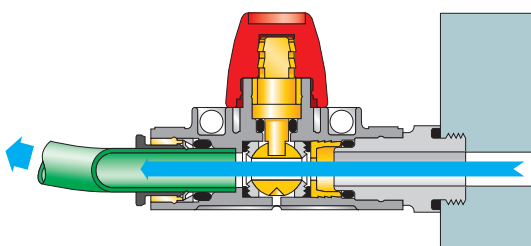

### Vented Valve, Closed Position

Lever with screwdriver slot

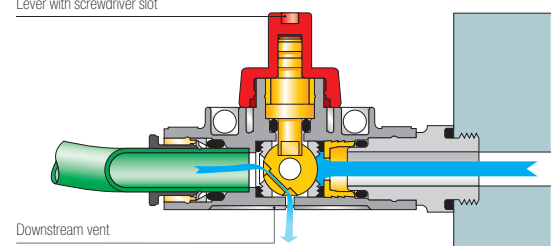

# Mini Series

## 7910 2/2 In-Line Mini-Ball Valve



Technical polymer, NBR

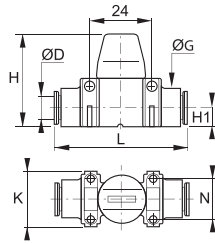

ØD		G	H	H1	K	L	N	Kg
4	<a href="#">7910 04 00</a>	15	37	7.5	22	51	16	0.039
6	<a href="#">7910 06 00</a>	15	37	7.5	22	52	16	0.034
8	<a href="#">7910 08 00</a>	15	37	7.5	22	52	16	0.025
10	<a href="#">7910 10 00</a>	20	43	11	30	66	22	0.060
12	<a href="#">7910 12 00</a>	20	43	11	30	66	22	0.040

## 7911 2/2 In-Line Mini-Ball Valve, Male BSPP Thread



Technical polymer, nickel-plated brass, NBR

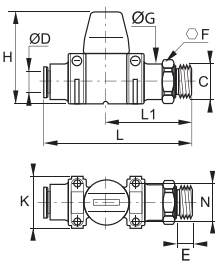

ØD	C		E	F	G	H	K	L	L1	N	Kg
6	G1/8	<a href="#">7911 06 10</a>	5	13	14	37	22	62	37	16	0.045
8	G1/4	<a href="#">7911 08 13</a>	5.5	16	17.5	37	22	61	35	16	0.040
10	G3/8	<a href="#">7911 10 17</a>	5.5	20	22	43	30	74	41	22	0.075
12	G1/2	<a href="#">7911 12 21</a>	7.5	24	26	43	30	75	42	22	0.075

## 7913 3/2 In-Line Mini-Ball Valve with Vent



Technical polymer, NBR

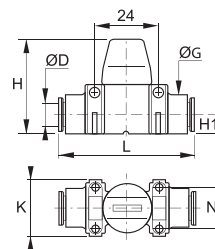

ØD		G	H	H1	K	L	N	Kg
4	<a href="#">7913 04 00</a>	15	37	7.5	22	51	16	0.040
6	<a href="#">7913 06 00</a>	15	37	7.5	22	52	16	0.035
8	<a href="#">7913 08 00</a>	15	37	7.5	22	52	16	0.025
10	<a href="#">7913 10 00</a>	20	43	11	30	66	22	0.060
12	<a href="#">7913 12 00</a>	20	43	11	30	66	22	0.045

## 7914 3/2 In-Line Mini-Ball Valve with Vent, Male BSPP Thread



Technical polymer, nickel-plated brass, NBR

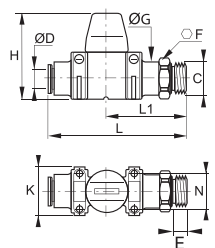

ØD	C		E	F	G	H	K	L	L1	N	Kg
6	G1/8	<a href="#">7914 06 10</a>	5	13	14	37	22	62	37	16	0.045
8	G1/4	<a href="#">7914 08 13</a>	5.5	16	17.5	37	22	61	35	16	0.040
10	G3/8	<a href="#">7914 10 17</a>	5.5	20	22	43	30	74	41	22	0.058
12	G1/2	<a href="#">7914 12 21</a>	7.5	24	26	43	30	75	42	22	0.075

## 7000 Joining Clips

Technical polymer



ØD		Kg
4	<a href="#">7000 00 05</a>	0.005
6	<a href="#">7000 00 05</a>	0.005
8	<a href="#">7000 00 05</a>	0.005
10	<a href="#">7000 00 06</a>	0.009
12	<a href="#">7000 00 06</a>	0.009

# LIQUIfit® Ball Valves

This range of valves offers an innovative solution in the treatment of **water and the handling of beverages** while protecting **health**. These **compact and reliable** valves offer perfect **sealing** and excellent **cleanliness**.

## Product Advantages

### Innovative Technology & Increased Reliability

- Full flow to limit turbulence
- Full-flow self-cleaning ball maintains the cleanliness of the circuit
- Tube retention with gripping ring prevents pumping effect
- Push-in connection and disconnection
- Sealing technology using patented EPDM seal

### High Performance

- Inert technical polymer providing the best mechanical strength, thermal and chemical resistance
- Carstick® connection providing resistance to water hammer
- Other configurations available on request



Beverage Dispensers  
Inert Gases  
Cooling  
Food Process  
Water Purification  
Water Coolers

Applications

## Technical Characteristics

<b>Compatible Fluids</b>	Water, drinks, beverages			
<b>Working Pressure</b>	0 to 10 bar at 20°C			
<b>Working Temperature</b>	-15°C to +100°C			

<b>Tightening Torques</b>	Threads	1/4" NPTF	3/8" NPTF	1/2" NPTF
	daN.m	1.5	3	3

### Component Materials

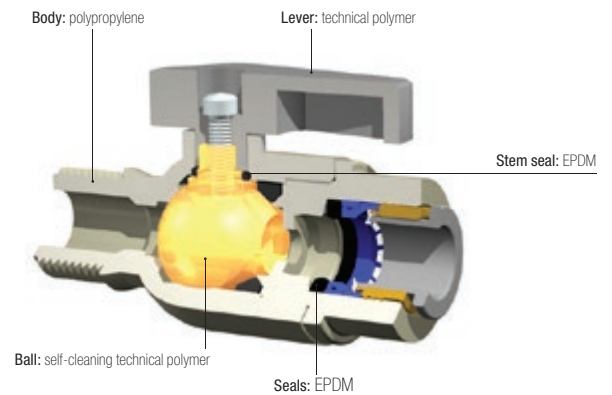

### Silicone-free

### Regulations

FDA: 21 CFR  
NSF: 51 and lead < 0.25%  
WQA: Water Quality Association

## 4020 2/2 In-Line Ball Valve



Polypropylene with fibreglass, EPDM

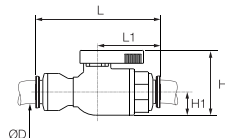

ØD		H	H1	L	L1	Kg
6	<a href="#">4020 06 00WP2</a>	36	13	57	27	0.019
8	<a href="#">4020 08 00WP2</a>	36	13	60	27	0.020
10	<a href="#">4020 10 00WP2</a>	36	13	70	33	0.023
12	<a href="#">4020 12 00WP2</a>	36.5	13	88	43	0.034

## 4020 2/2 In-Line Ball Valve

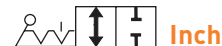

Polypropylene with fibreglass, EPDM

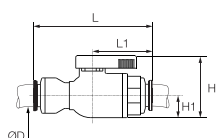

ØD		H	H1	L	L1	Kg
1/4	<a href="#">4020 56 00WP2</a>	25	13	65	31	0.025
3/8	<a href="#">4020 60 00WP2</a>	36	13	68	30.5	0.034

## 4021 2/2 In-Line Ball Valve, Male NPTF Thread

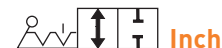

Polypropylene with fibreglass, EPDM

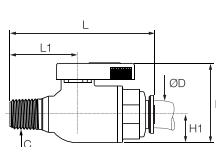

ØD	C		H	H1	L	L1	Kg
1/4	NPTF1/4	<a href="#">4021 56 14WP2</a>	36	13	61	31	0.029
3/8	NPTF3/8	<a href="#">4021 60 18WP2</a>	36	13	64	33.5	0.028

## 4023 2/2 In-Line Ball Valve, Female NPTF Thread



Polypropylene with fibreglass, EPDM

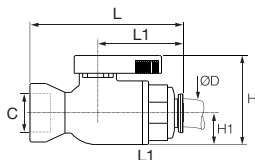

ØD	C		H	H1	L	L1	Kg
1/4	NPTF1/4	<a href="#">4023 56 14WP2</a>	36	13	58	31	0.025
3/8	NPTF3/8	<a href="#">4023 60 18WP2</a>	36	13	64	33.5	0.028

## 4022 2/2 Right-Angled Ball Valve, Female NPTF Thread



Polypropylene with fibreglass, EPDM

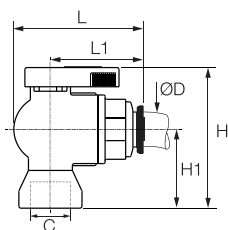

ØD	C		H	H1	L	L1	Kg
1/4	NPTF1/4	<a href="#">4022 56 14WP2</a>	52	29	44	31	0.026
3/8	NPTF3/8	<a href="#">4022 60 18WP2</a>	52	29	47	33.5	0.031

## 4024 2/2 Right-Angled Ball Valve



Polypropylene with fibreglass, EPDM

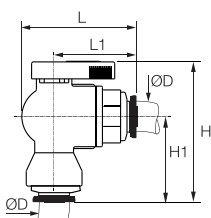

ØD		H	H1	L	L1	Kg
6	<a href="#">4024 06 00WP2</a>	54	31	41	27	0.020
8	<a href="#">4024 08 00WP2</a>	56	33	41	27.5	0.020
10	<a href="#">4024 10 00WP2</a>	61	38	47	33	0.024
12	<a href="#">4024 12 00WP2</a>	63	40	57	43	0.031

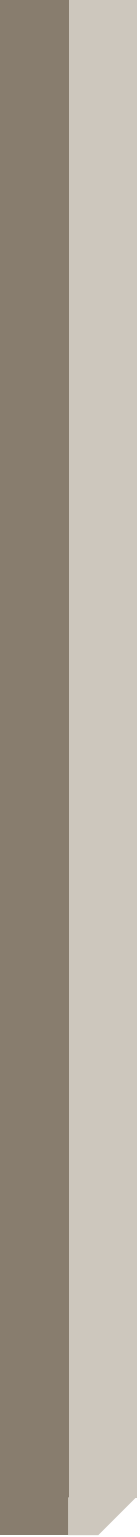

# Needle and Butterfly Valve Range

## Brass Needle Valves

### In-Line

**0502**  
Page 6-39

**0501**  
Page 6-39

**0510**  
Page 6-39



### Right-Angled

**0532**  
Page 6-39

**0531**  
Page 6-39



### Drain Valve

**0562**  
BSPP/Metric  
Page 6-40

**0563**  
NPT  
Page 6-40



### Venting Pressure Gauge Valve

**0627**  
BSPP  
Page 6-40



### Pressure Relief Valve

**0630**  
BSPP  
Page 6-40



## Stainless Steel Needle Valve

### In-Line

**0591**  
Page 6-41



## Butterfly Valve

### In-Line

**4602**  
Page 6-43



# Needle Valves

Parker Legris compact needle valves can be installed in any system and are designed for applications requiring accurate **leak-free fluid control** and **excellent service life**.

## Product Advantages

- Robust and Easy-to-Use**
  - Accurate flow control
  - Forged brass for improved long-term mechanical strength
  - Robust stem for good operational reliability
  - Corrosion resistance
- Wide Range**
  - Two materials (nickel-plated brass and stainless steel) suitable for many applications
  - Numerous valve and safety accessory configurations



Pneumatics  
Water Circuits  
Machine Tools  
Rubber Industry  
Packaging  
Textile

Applications

## Technical Characteristics

	Brass	Stainless Steel			
<b>Compatible Fluids</b>	Compressed air, water, industrial fluids, etc. Other fluids: contact us	Many fluids			
<b>Working Pressure</b>	0 to 120 bar	0 to 400 bar			
<b>Working Temperature</b>	-20°C to +100°C (except model 0510)	-20°C to +180°C			
<b>Tightening Torques</b>	Threads	G1/8	G1/4	G3/8	G1/2
	daN.m	0.10 to 0.20	0.10 to 0.20	0.15 to 0.25	0.20 to 0.35

Reliable performance is dependent upon the type of fluid conveyed.

### Component Materials

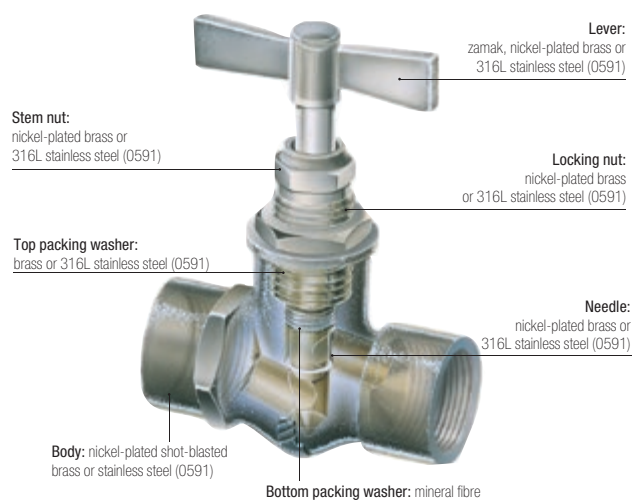

### Silicone-free

### Regulations

- DI: 97/23/EC (module PED A - diameters greater than 25 mm)
- DI: 2006/42/EC (Machinery Directive)
- DI: 2002/95/EC (RoHS)
- RG: 1907/2006 (REACH)



# Brass Needle Valves

## 0502 In-Line Needle Valve, Female BSPP Thread

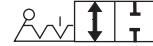

Nickel-plated brass

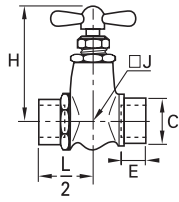

DN	C		E	H	H <sub>max</sub>	J	L/2	Kg
4	G1/8	0502 04 10	9	56	50	17	23	0.133
	G1/4	0502 04 13	11	56	50	17	23	0.118
6	G3/8	0502 06 17	12	67	60	-	26	0.171
9	G3/8	0502 09 17	12	82	70	-	33	0.426

## 0501 In-Line Needle Valve, Male/Female BSPP Thread



Nickel-plated brass

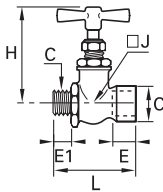

DN	C		E	E1	H	H <sub>max</sub>	J	L	Kg
4	G1/8	0501 04 10	9	7	56	50	17	44	0.118
	G1/4	0501 04 13	11	9.5	56	50	17	46	0.115
6	G3/8	0501 06 17	12	9.5	67	60	-	48	0.158

## 0510 In-Line Needle Valve with Compression Connections

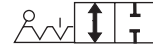

Nickel-plated brass

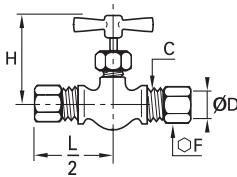

DN	ØD	C		F	H <sub>min</sub>	H <sub>max</sub>	L/2	Kg
4	6	M10x1	0510 04 06	13	42	46	29	0.083
8	8	M12x1	0510 05 08	14	42	46	30	0.083
5	10	M16x1.5	0510 05 10	19	42	46	31	0.111

The needle is sealed by an O-ring.  
 Maximum operating pressure: Ø4: 100 bar, Ø5: 60 bar  
 Working temperature: -15°C to +70°C  
 Tightening torques: please refer to the Compression Fittings chapter of this catalogue.

## 0532 Right-Angle Needle Valve, Female BSPP Thread

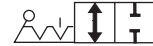

Nickel-plated brass

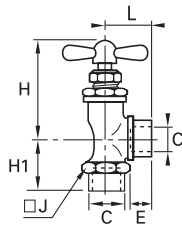

DN	C		E	H <sub>min</sub>	H <sub>max</sub>	H1	J	L	Kg
4	G1/8	0532 04 10	9	46	52	19	17	19	0.093
	G1/4	0532 04 13	11	46	52	21	17	21	0.087
6	G1/4	0532 06 13	11	55	63	26	22	26	0.171

## 0531 Right-Angle Needle Valve, Male/Female BSPP Thread



Nickel-plated brass

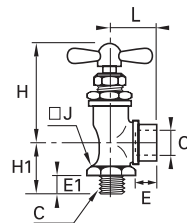

DN	C		E	E1	H <sub>min</sub>	H <sub>max</sub>	H1	J	L	Kg
4	G1/8	0531 04 10	7	9	46	52	19	17	19	0.082
	G1/4	0531 04 13	9.5	11	46	52	21	17	21	0.090
6	G1/4	0531 06 13	9.5	11	55	63	25	22	26	0.155
	G3/8	0531 06 17	9.5	12	55	63	25	22	27	0.153
10	G1/2	0531 10 21	13	16	62	72	34	26	33	0.329

# Brass Needle Valves

## 0562 Needle Drain Valve, Male BSPP and Metric Thread

Brass

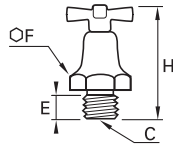

DN	C		E	F	H min	H max	Kg
5	M10x1	0562 05 60	8	16	37.5	40	0.031
	G1/8	0562 05 10	8	16	36	40	0.032
	G1/4	0562 05 13	10	19	38.5	42.5	0.040

## 0563 Needle Drain Valve, Male NPT Thread

Brass

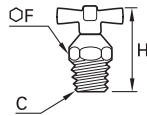

DN	C		F	H min	H max	Kg
5	G1/4	0563 05 14	14	28.5	32.5	0.021

## 0627 Automatic Vent Pressure Gauge Valve, Female BSPP Thread

Nickel-plated brass, NBR

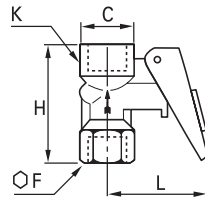

C		F	H	K	L	Kg
G1/4	0627 00 13	19	43.5	20	40	0.097

Pressure: 10 bar

This isolating valve is used to connect a pressure gauge to a circuit.

Resetting the lever isolates and vents the gauge.

A locking pin can be used to enable the gauge to be fitted permanently.

## 0630 Pressure Relief Valve, Male BSPP Thread

Brass

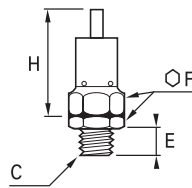

C		E	F	H	Kg
G1/4	0630 06 13	9	17	42.5	0.050

This valve is delivered without calibration, but can be adjusted by inserting metal washers into the hexagon (F).

Maximum working pressure: 10 bar

Calibration from 1 to 10 bar (not below)

# Stainless Steel Needle Valves

**0591**

Needle Valve, Female BSPP Thread



Stainless steel 316L, PTFE

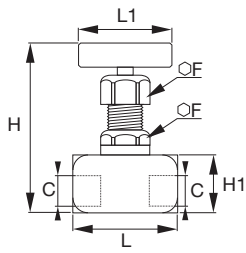

DN	C		F	H min	H max	H1	L	L1	Kg
3	G1/8	<a href="#">0591 03 10</a>	22	90	99	25	45	48	0.345
4	G1/4	<a href="#">0591 04 13</a>	22	90	99	25	50	48	0.355
5	G3/8	<a href="#">0591 05 17</a>	22	90	104	30	56	48	0.430
6	G1/2	<a href="#">0591 06 21</a>	22	90	104	30	62	48	0.483

# Butterfly Valves

In these robust valves, the internal component used to shut off the flow is a segment of a sphere. This allows **frequent operation with very low torque, no fluid retention areas** and therefore excellent mechanical performance.

## Product Advantages

### Compact & Abrasion-Resistant

- Excellent with abrasive fluids (including solid particles)
- Fluid flow direction marked for greater safety (uni-directional)
- Smooth operation
- Can be easily adapted for use with auxiliary actuators
- More compact than a ball valve with equivalent nominal diameter
- Simple and efficient design for a long service life

- ### Applications
- Painting & Printing
  - Machine Tools
  - Pneumatics
  - Powder Conveyance
  - Plumbing
  - Rubber Industry
  - Petrochemical

## Technical Characteristics

<b>Compatible Fluids</b>	Compressed air, industrial gases, water, cutting oils, hydraulic oils, fuel oil, fuel, etc.
<b>Working Pressure</b>	0 to 16 bar
<b>Working Temperature</b>	-20°C to +80°C

Reliable performance is dependent upon the type of fluid conveyed.

### Component Materials

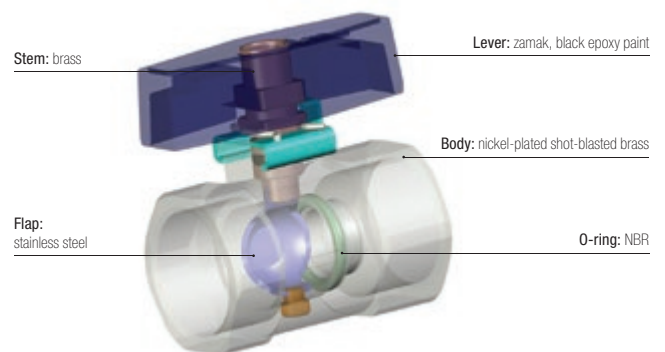

### Silicone-free

### Regulations

- DI: 97/23/EC (module PED A - diameters greater than 25 mm)
- DI: 2006/42/EC (Machinery Directive)
- DI: 2002/95/EC (RoHS)
- RG: 1907/2006 (REACH)

# Butterfly Valves

## 4602 2/2 Butterfly Shut-Off Valve, Female BSPP Thread

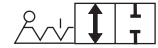

Nickel-plated brass, NBR

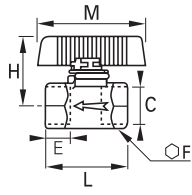

DN	C		E	F	H	L	M	Kg
6	G1/4	<a href="#">4602 06 13</a>	9	17	35	34	54	0.102
7	G3/8	<a href="#">4602 07 17</a>	11	22	35	39	54	0.136
10	G1/2	<a href="#">4602 10 21</a>	12	24	37	42	54	0.140
13	G3/4	<a href="#">4602 13 27</a>	14	30	40	49	54	0.208
18	G1	<a href="#">4602 18 34</a>	15	41	46	55	54	0.412

Black epoxy-coated zamak handle



# Axial Valve Range

## In-Line Normally Closed

**4202..20**  
FKM Seal  
2/2  
Page 6-48



**4202..30**  
EPDM Seal  
2/2  
Page 6-48



## In-Line Normally Open

**4212..20**  
FKM Seal  
2/2  
Page 6-48



**4212..30**  
EPDM Seal  
2/2  
Page 6-48



## In-Line Double-Acting

**4222..20**  
FKM Seal  
2/2  
Page 6-48



**4222..30**  
EPDM Seal  
2/2  
Page 6-49



## Accessories

**4298**  
Sub-Base  
Page 6-49



**4298**  
Solenoid Valve  
Page 6-49



**4299**  
Pneumatic Button  
Page 6-49



# Axial Valves

The Parker Legris axial valve is the only valve to incorporate both the **valve and actuation function**. With pneumatic or electro-pneumatic control, it avoids many of the restrictions associated with traditional actuators.

## Product Advantages

### Optimisation & Safety

- Very compact: up to 50% smaller than valves with separate actuators
- Simple to install: ready-to-use
- Common sub-base for solenoid control
- Automation of the open/close function
- Operation independent of the upstream and downstream pressure in the circuit

### Comprehensive Offer

- Two seal materials for a wider chemical and temperature range
- Pneumatic, electro-pneumatic or dual actuation control
- Three versions: normally closed, normally open and double-acting

### Performance

- Full flow: low pressure drop
- Excellent pressure/temperature performance
- Compatible with many industrial fluids



- Applications**
- Flow Control
  - Plastic Injection Moulding
  - Rubber Industry
  - Pneumatics
  - Textile
  - Printing
  - Packaging
  - Robotics

## Technical Characteristics

<b>Compatible Fluids</b>	Depending on type of seal – FKM: water, air, oils, greases, etc. – EPDM: hot water, air, steam, etc.
<b>Working Pressure</b>	10 bar max.
<b>Pilot Pressure</b>	NC and NO: 4.2 to 8 bar Double-acting: 3 to 8 bar
<b>Working Temperature</b>	-20°C to +135°C (suffix 20 FKM) -20°C to +120°C (suffix 30 EPDM)

<b>Tightening Torques</b>	Threads	G3/8	G1/2	G3/4	G1	G1¼	G1½	G2
	daN.m	0.15 to 0.25	0.20 to 0.35	0.50 to 0.70	0.50 to 0.70	0.40 to 0.60	0.80 to 1.20	0.80 to 1.20

Reliable performance is dependent upon the type of fluid conveyed, component materials and tubing being used.  
Guaranteed for use with a vacuum of 740 mm Hg (97% vacuum).

### Flow Curve and Pressure Drop (Kv)

**Kv in m³/h** (ambient water temperature, under a differential pressure of 1 bar)

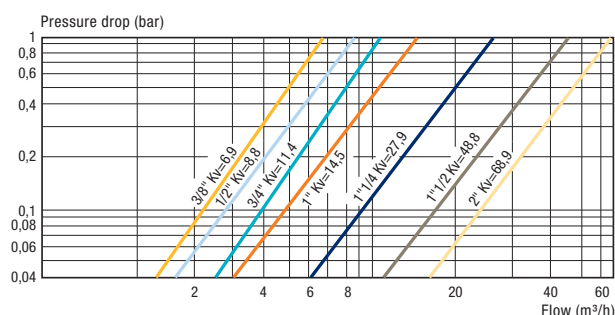

### Component Materials

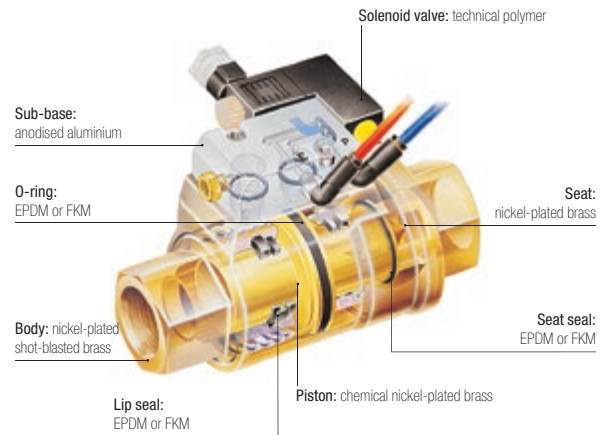

### Silicone-free

### Regulations

- DI: 97/23/EC (module PED A - diameters greater than 25 mm)
- DI: 2006/42/EC (Machinery Directive)
- DI: 2002/95/EC (RoHS)
- RG: 1907/2006 (REACH)
- DI: 94/9/EC (ATEX) - for pneumatic operation versions



# Axial Valves

## Operation

Depending on operational requirement, air is passed into the actuation chamber to open or close the valve.

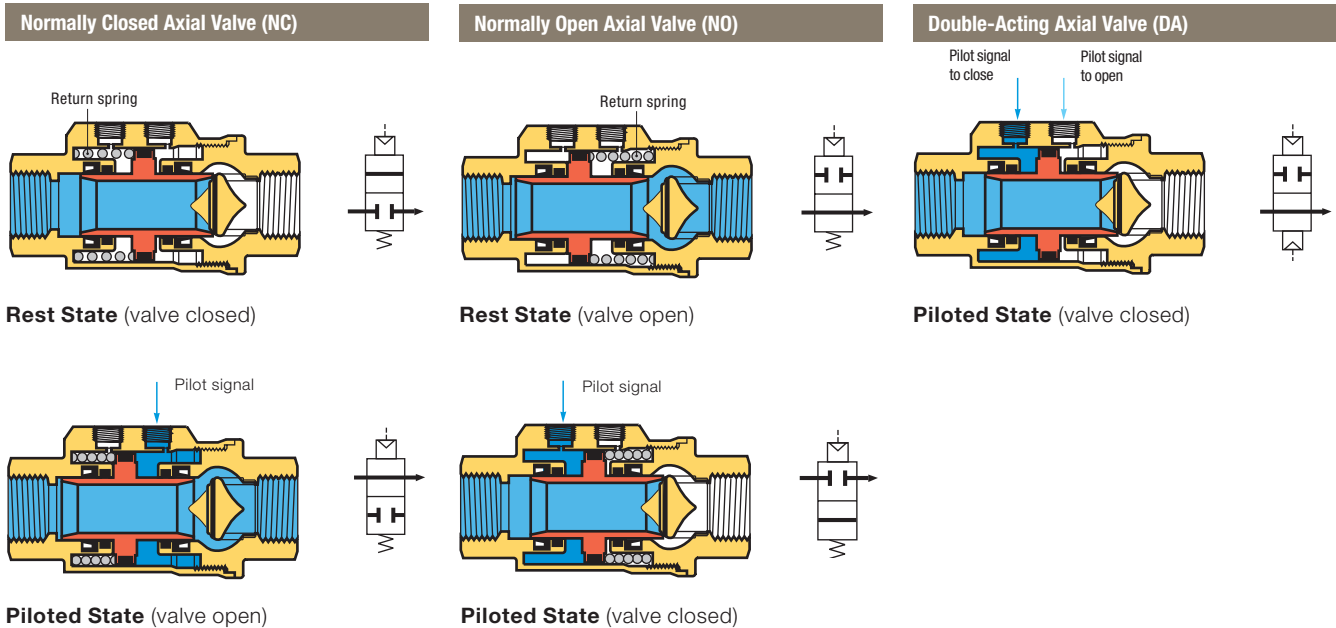

## Installation Options

The Parker Legris axial valve offers 3 different control methods dependant on the requirements of the installation:

### Pneumatic Control

**Example:** Double-acting axial valve 4222

- local compressed air control
- for repetitive on/off cycles
- remote control where access to the machine is difficult
- for explosive or explosion prevention areas

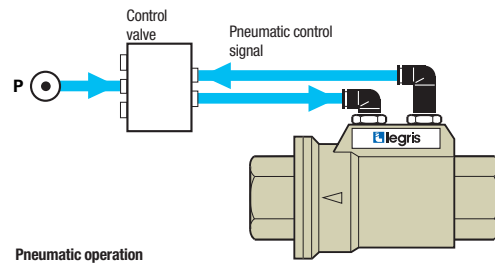

### Electro-Pneumatic Control

**Example:** Normally closed axial valve 4202 + sub-base and Mini-solenoid valve 4298

- for automated industrial systems requiring remote control
- Namur seating plane solenoid valve

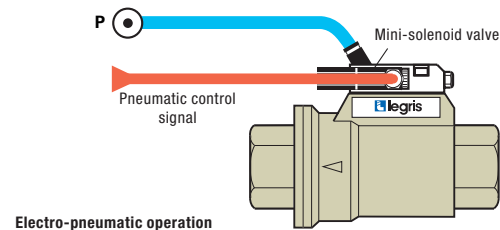

### Dual Pneumatic and Electro-Pneumatic Control

**Example:** Normally open axial valve 4212 + sub-base and Mini-solenoid valve 4298 + Pneumatic push-button 4299

- dual control structure
- for increased safety: prevents localised operating errors
- Namur seating plane solenoid valve

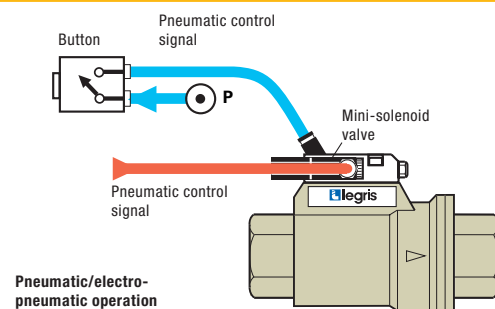

# Axial Valves

## 4202..20 Normally Closed Axial Valve with FKM Seal, Female BSPP Thread

Nickel-plated brass, FKM

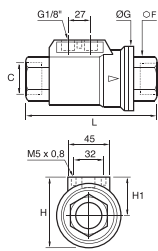

C		F	G	H	H1	L	Kg
G3/8	<a href="#">4202 10 17 20</a>	22	46	54	31	98	0.815
G1/2	<a href="#">4202 15 21 20</a>	27	52	60	35	112	1.093
G3/4	<a href="#">4202 20 27 20</a>	33	64	70	38	135	1.624
G1	<a href="#">4202 25 34 20</a>	41	69	76	41.5	143	2.033
G1 1/4	<a href="#">4202 32 42 20*</a>	50	86	91	48	165	3.266
G1 1/2	<a href="#">4202 40 49 20*</a>	60	96	102	54	180	4.195
G2	<a href="#">4202 50 48 20*</a>	75	109	115	60.5	207	6.465

Pilot port: G1/8

Complete with M5 silencer

\*Models with EC marking

## 4202..30 Normally Closed Axial Valve with EPDM seal, Female BSPP Thread

Nickel-plated brass, EPDM

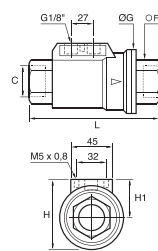

C		F	G	H	H1	L	Kg
G3/8	<a href="#">4202 10 17 30</a>	22	46	54	31	98	0.828
G1/2	<a href="#">4202 15 21 30</a>	27	52	60	35	112	1.097
G3/4	<a href="#">4202 20 27 30</a>	33	64	70	38	135	1.606
G1	<a href="#">4202 25 34 30</a>	41	69	76	41.5	143	2.013
G1 1/4	<a href="#">4202 32 42 30*</a>	50	86	91	48	165	3.315
G1 1/2	<a href="#">4202 40 49 30*</a>	60	96	102	54	180	4.195
G2	<a href="#">4202 50 48 30*</a>	75	109	115	60.5	207	6.360

Pilot port: G1/8

Delivered with a silencer

\*Models with EC marking

## 4212..20 Normally Open Axial Valve with FKM Seal, Female BSPP Thread

Nickel-plated brass, FKM

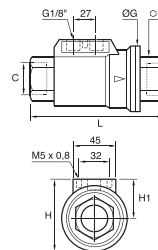

C		F	G	H	H1	L	Kg
G3/8	<a href="#">4212 10 17 20</a>	22	46	54	31	98	0.828
G1/2	<a href="#">4212 15 21 20</a>	27	52	60	35	112	1.096
G3/4	<a href="#">4212 20 27 20</a>	33	64	70	38	135	1.637
G1	<a href="#">4212 25 34 20</a>	41	69	76	41.5	143	2.025
G1 1/4	<a href="#">4212 32 42 20*</a>	50	86	91	48	165	3.301
G1 1/2	<a href="#">4212 40 49 20*</a>	60	96	102	54	180	4.188
G2	<a href="#">4212 50 48 20*</a>	75	109	115	60.5	207	6.555

Pilot port: G1/8

Complete with M5 silencer

\*Models with EC marking

## 4212..30 Normally Open Axial Valve with EPDM seal, Female BSPP Thread

Nickel-plated brass, EPDM

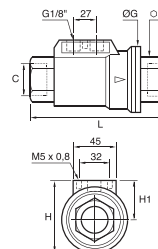

C		F	G	H	H1	L	Kg
G3/8	<a href="#">4212 10 17 30</a>	22	46	54	31	98	0.827
G1/2	<a href="#">4212 15 21 30</a>	27	52	60	35	112	1.152
G3/4	<a href="#">4212 20 27 30</a>	33	64	70	38	135	1.595
G1	<a href="#">4212 25 34 30</a>	41	69	76	41.5	143	1.993
G1 1/4	<a href="#">4212 32 42 30*</a>	50	86	91	48	165	3.301
G1 1/2	<a href="#">4212 40 49 30</a>	60	96	102	54	180	4.775
G2	<a href="#">4212 50 48 30*</a>	75	109	115	60.5	207	6.360

Pilot port: G1/8

Delivered with a silencer

\*Models with EC marking

# Axial Valves

## 4222..20 Double-Acting Axial Valve with FKM Seal, Female BSPP Thread

Nickel-plated brass, FKM

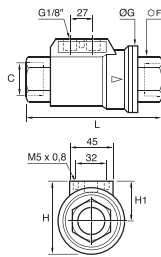

C		F	G	H	H1	L	Kg
G3/8	<a href="#">4222 10 17 20</a>	22	46	54	31	98	0.802
G1/2	<a href="#">4222 15 21 20</a>	27	52	60	35	112	1.050
G3/4	<a href="#">4222 20 27 20</a>	33	64	70	38	135	1.571
G1	<a href="#">4222 25 34 20</a>	41	69	76	41.5	143	1.942
G1 1/4	<a href="#">4222 32 42 20*</a>	50	86	91	48	165	3.058
G1 1/2	<a href="#">4222 40 49 20*</a>	60	96	102	54	180	3.995
G2	<a href="#">4222 50 48 20*</a>	75	109	115	60.5	207	6.275

Pilot port: G1/8

\*Models with EC marking

## 4222..30 Double-Acting Axial Valve with EPDM seal, Female BSPP Thread

Nickel-plated brass, EPDM

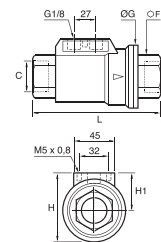

C		F	G	H	H1	L	Kg
G3/8	<a href="#">4222 10 17 30</a>	22	46	54	31	98	0.832
G1/2	<a href="#">4222 15 21 30</a>	27	52	60	35	112	1.046
G3/4	<a href="#">4222 20 27 30</a>	33	64	70	38	135	1.662
G1	<a href="#">4222 25 34 30</a>	41	69	76	41.5	143	1.943
G1 1/4	<a href="#">4222 32 42 30*</a>	50	86	91	48	165	3.301
G1 1/2	<a href="#">4222 40 49 30*</a>	60	96	102	54	180	4.260
G2	<a href="#">4222 50 48 30*</a>	75	109	115	60.5	207	6.520

Pilot port: G1/8

Delivered with a silencer

\*Models with EC marking

## 4298 Sub-Base for Solenoid Pilot Valve

Treated aluminium, NBR

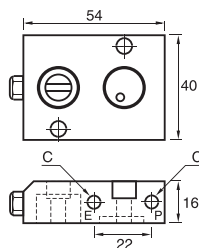

C		Kg
M5x0.8	<a href="#">4298 00 01</a>	0.095

The sub-base is fitted directly to the axial valve and allows the mounting of a 15x15 solenoid valve. Supplied with 2 fixing bolts, silencer and seats.

## 4298 Mini-Solenoid Valve 1W/12VA

Anodised aluminium

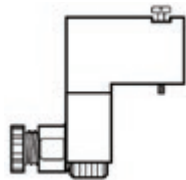

Voltage		Kg
24V = CC*	<a href="#">4298 01 01</a>	0.051
24V ~ CA**	<a href="#">4298 01 02</a>	0.058
110V ~ CA**	<a href="#">4298 02 01</a>	0.051
220V ~ CA**	<a href="#">4298 02 02</a>	0.054

\*Direct current

\*\*Alternating current

## 4299 Pneumatic Button/Electro-Pneumatic

Nickel-plated brass, technical polymer

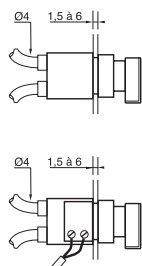

Contact		Kg
Standard*	<a href="#">4299 01 01</a>	0.090
With key*	<a href="#">4299 01 02</a>	0.110
Standard**	<a href="#">4299 02 01</a>	0.102
With key**	<a href="#">4299 02 02</a>	0.124

Bulkhead fixing hole diameter: Ø22 mm

\*1 pneumatic contact

\*\*1 electro-pneumatic contact

Available upon request





# Industrial Blowguns

**Polymer**

**Metal**

**Kits**

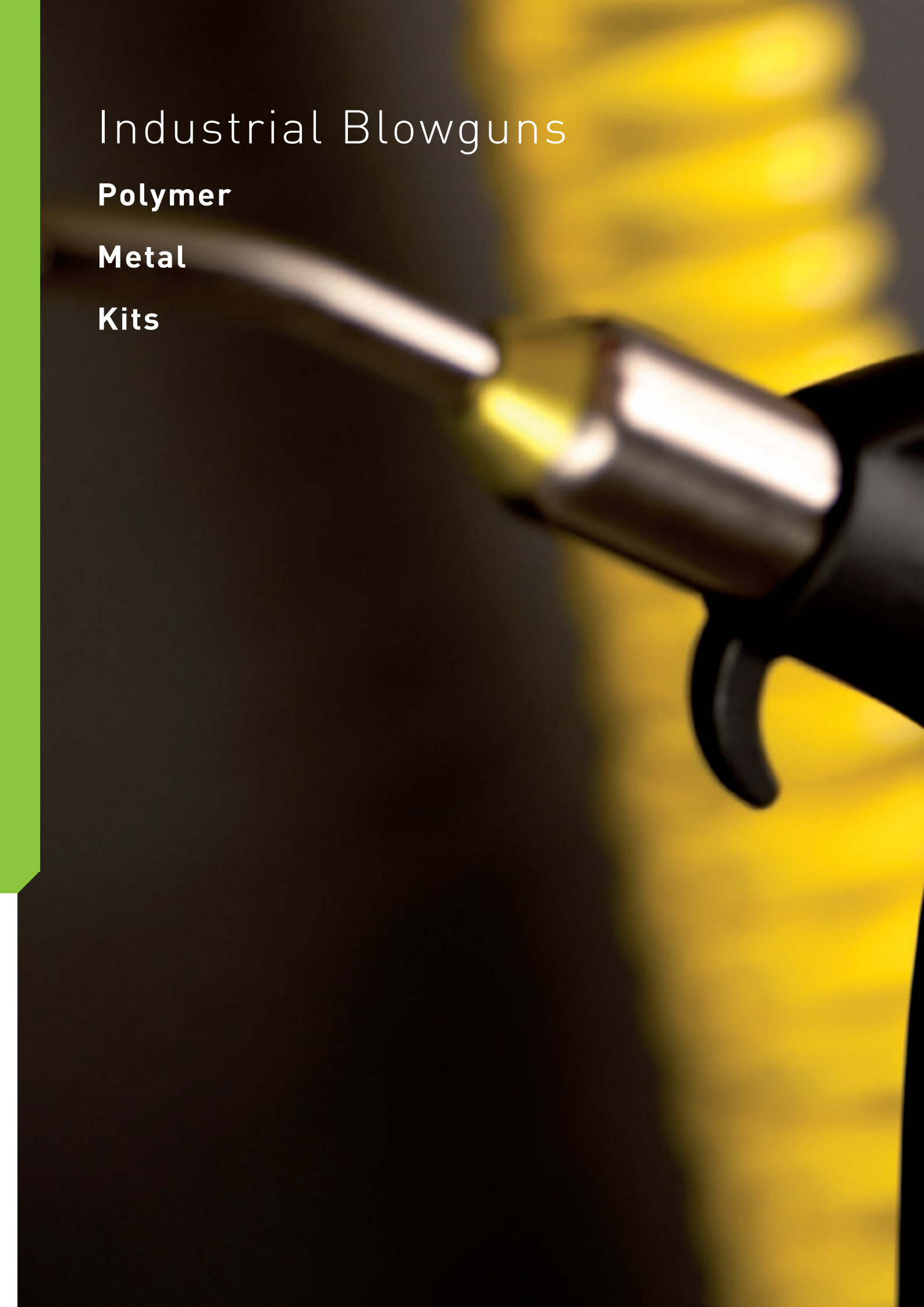



 **Elegris**



# Blowguns

## Standard Blowgun (P. 7-7)



**Fluids:** compressed air  
**Materials:** technical polymer, NBR  
**Pressure:** 10 bar  
**Temperature:** -15°C to +50°C  
**DN:** : 3.5 mm

## Safety Blowgun (P. 7-7)



**Fluids:** compressed air  
**Materials:** technical polymer, NBR  
**Pressure:** 10 bar  
**Temperature:** -15°C to +50°C  
**DN:** : 3 mm

## Energy-Saving Blowgun (P. 7-8)



**Fluids:** compressed air  
**Materials:** technical polymer, NBR  
**Pressure:** 10 bar  
**Temperature:** -15°C to +50°C  
**DN:** : according to nozzle

## Versatile Blowguns (P. 7-6)



**Fluids:** compressed air  
**Materials:** technical polymer, NBR  
**Pressure:** 10 bar  
**Temperature:** -15°C to +50°C  
**DN:** : according to nozzle

## Metal Blowguns (P. 7-14)



**Fluids:** compressed air  
**Materials:** forged nickel-plated brass, NBR  
**Pressure:** 10 bar  
**Temperature:** -15°C to +50°C  
**DN:** : 2 mm

## Water Pistol (P. 7-14)



**Fluids:** industrial fluids and water  
**Materials:** zamak, NBR  
**Pressure:** 20 bar  
**Temperature:** -20°C to +100°C  
**DN:** : 12 mm

## Blowgun Kits (P. 7-16)



**Fluids:** compressed air  
**Materials:** technical polymer  
**Pressure:** 10 bar  
**Temperature:** -15°C to +50°C  
**DN:** : according to model

## Nozzles (P. 7-11)



**Fluids:** compressed air  
**Materials:** nickel-plated brass  
**Pressure:** 10 bar  
**Temperature:** -15°C to +50°C  
**DN:** : according to model



# Blowgun Range

## Polymer Blowguns

### Standard

**0659**  
Page 7-7



### Safety

**0654**  
Page 7-7



### SUVA Safety

**0654**  
Page 7-7



### Energy-Saving

**0653**  
Lower Connection  
Interchangeable Nozzle  
Page 7-8



**0653**  
Lower Connection  
Page 7-8



### With Interchangeable Nozzle

**0652**  
Lower Connection  
Page 7-8



**0655**  
Upper Connection  
Page 7-8



### Pre-Assembled with Nozzle

**0651**  
Lower Connection  
Page 7-9



**0658**  
Upper Connection  
Page 7-9



**0656**  
Lower Connection  
Page 7-9



**0657**  
Upper Connection  
Page 7-9



### Merchandising Box

**065.. 13 02**  
Page 7-10



## Nozzles for Polymer Blowguns

**0690 01**  
Standard  
Page 7-11



**0690 02**  
Safety  
Page 7-11



**0690 03**  
Straight Tube (long)  
Page 7-11



**0690 04**  
Straight Tube (short), Safety  
Page 7-11



**0690 05**  
Angled Tube (long)  
Page 7-11



**0690 06**  
Angled Tube (short) Safety  
Page 7-12



**0690 06 01**  
Angled Tube (short)  
Page 7-12



**0690 07**  
LF 3000® Nozzle  
Page 7-12



**0690 08**  
Coanda  
Page 7-12



**0690 09**  
Air Screen  
Page 7-12



**0690 10**  
Booster  
Page 7-13



**0690 11**  
Booster with Air Screen  
Page 7-13



## Metal Blowguns

### Lever-Operated

**0623**  
Page 7-15



### Button-Operated

**0622**  
Page 7-15



### Water Pistol

**2299**  
Page 7-15



**2299**  
Page 7-15



## Blowgun Kits

**0631..09**  
Standard  
Page 7-17



**0631..01**  
Safety  
Page 7-17



**0631..30**  
Safety, SUVA-Certified  
Page 7-17



**0631..23**  
Energy-Saving  
Page 7-17



**0631..03**  
**0631..02**  
Standard Nozzle  
Page 7-18



**0631..05**  
**0631..04**  
Angled Nozzle, Safety  
Page 7-18



**0631..07**  
**0631..06**  
Interchangeable Nozzle  
Page 7-18



**0631..08**  
Energy-Saving  
Interchangeable Nozzle  
Page 7-18



# Polymer Blowguns

The Parker Legris polymer blowgun offers **ease of use**, **energy saving**, adaptability and efficiency. These blowguns comply with **international regulations** for health, **safety** and **noise** levels.

## Product Advantages

### Quality & Performance

- Comply with international standards for noise and pressure regulation
- Powerful flow with progressive control
- Rotating nozzle for directional jet
- Durable, shock-resistant materials
- 100% leak and flow-tested in production
- Date coding to guarantee quality and traceability

### Safety & Sustainable Development

- 40% energy consumption reduction with Energy-Saving model
- Complete user safety with the Safety model
- Wide selection of nozzles which comply with noise and pressure level regulations

### Ergonomics & Versatility

- Comfortable to use
- Lightweight and easy to use
- Wide range of models and nozzles for optimum blowing power and flow rate
- Lower or upper connection



Manufacturing Workshops

- Cleaning
- Blowing
- Mixing
- Ejection
- Cooling
- Packaging

Applications

## Technical Characteristics

<b>Compatible Fluids</b>	Compressed air Other fluids: contact us
<b>Working Pressure</b>	0 to 10 bar
<b>Working Temperature</b>	Air: -15°C to +50°C Dry air: -20°C to +80°C
<b>Tubes</b>	Recoil tubes and hose

### Regulations

#### Compliance for all blowguns:

- DI: 97/23/EC (PED)
- DI: 2002/95/EC (RoHS), 2011/65/EC
- DI: 1907/2006 (REACH)

#### Protection of design

All designs and models of Parker Legris blowguns have been registered with the following numbers: 13224 / 13225 / 13226.

#### Compliance for specific blowguns:

- DI: 1910.242 (b) [OSHA]  
The static pressure must be less than 30 psi in case the nozzle becomes blocked.
- DI: 1910.95 (b) [OSHA]  
The noise level must be less than 90 dBA over 8 hours' exposure.
- DI: 2003/10/EC  
Regulation relating to exposure to noise, particularly with regard to risks to hearing. The noise level must be less than 87 dBA.

### Component Materials



### Silicone-free

# Polymer Blowguns

## 0659 Standard Blowgun, Lower Connection with Short Angled Nozzle, Female BSPP Thread

Technical polymer, nickel-plated brass, treated aluminium, NBR

C	DN		F	H	L	Kg
G1/4	3.5	0659 00 13	20	120	223	0.072

Nozzle: aluminium, NPT version available

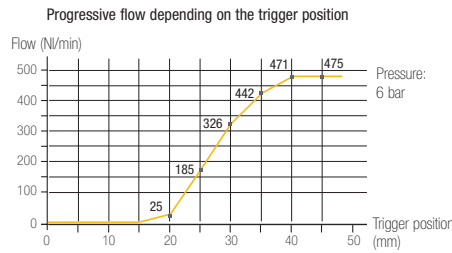
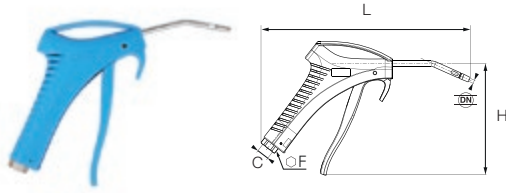

-  475 Nl/min
-  82 dBA
-  OSHA 1910.242 (b)  
OSHA 1910.95 (b)  
2003/10/EC directive:  
Requirement to use ear protection  
if exposure > 8 hours

## 0654 Safety Blowgun, Lower Connection, Female BSPP Thread

Technical polymer, nickel-plated brass, NBR

C	DN		F	H	H1	L	L1	Kg
G1/4	3	0654 00 13	20	117	35	148	73	0.189

Nozzle: nickel-plated brass, NPT version available.

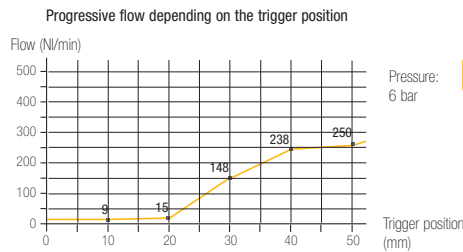
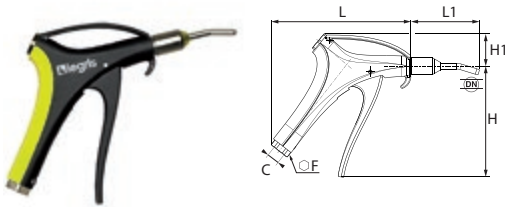

-  250 Nl/min
-  80 dBA
-  OSHA 1910.242 (b)  
OSHA 1910.95 (b)  
2003/10/EC directive:  
No ear defenders necessary

## 0654 SUVA Safety Blowgun, Lower Connection, Female BSPP Thread

Technical polymer, nickel-plated brass, NBR

C	DN		F	H	H1	L	L1	Kg
G1/4	3	0654 00 13	20	117	35	148	73	0,189

Nozzle: nickel-plated brass, NPT version available.

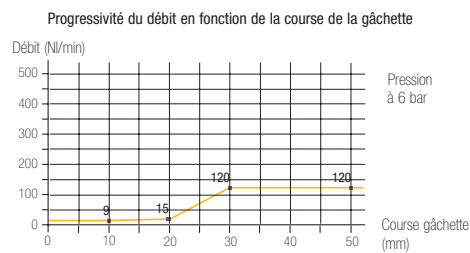
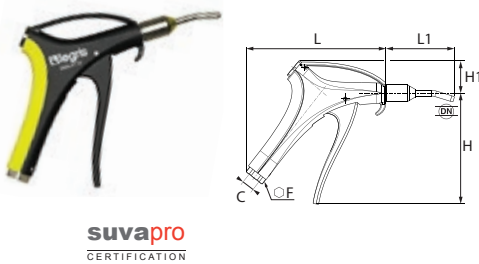

- 120 Nl/min
- 80 dBA
- OSHA 1910.242 (b)  
OSHA 1910.95 (b)  
Directive 2003/10/CE :  
Aucun écouteur auditif nécessaire  
SUVA: 7030d et 7030e

 Maximum Flow Rate  
(tolerance +/-10%)

 Noise Level  
ISO 15744

 Diffusion  
Cone

 Compliance  
with Standards

### Operation: Safety Blowgun



Flow stopped completely and pressure reduced to 0.5 bar

### Operation: Blowgun with Safety Nozzle



Flow diverted and pressure reduced to 0.5 bar

**ECO  
DESIGN** 

# Polymer Blowguns

## 0653 Energy Saving Blowgun, Lower Connection with Interchangeable Nozzle, Female BSPP Thread

Technical polymer, nickel-plated brass, NBR

C	C1		F	H	H1	L	Kg
G1/4	M12x1.25	<b>0652 66 13</b>	20	117	34	147	0.163

Flow characteristics depend on the type of nozzle used.

Delivered without nozzle.

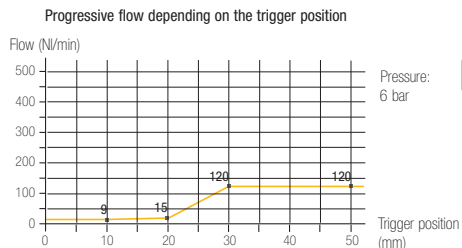
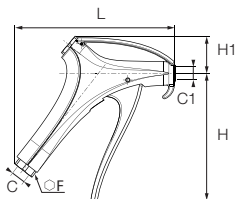

 120 Nl/min Flow produced with nozzle 0690 01 00  
 80 dBA Noise level measured without nozzle  
 OSHA 1910.242 (b): Depends on type of nozzle  
 OSHA 1910.95 (b)  
 2003/10/EC directive:  
 No ear defenders necessary

## 0653 Energy Saving Blowgun, Lower Connection with Short Angled Nozzle, Female BSPP Thread

Technical polymer, nickel-plated brass, NBR

C	C1		F	H	H1	L	L1	Kg
G1/4	M12x1.25	<b>0653 02 13</b>	20	117	34	147	78	0.144

Flow characteristics depend on the type of nozzle used, delivered without nozzle.

An energy saving calculator is available.

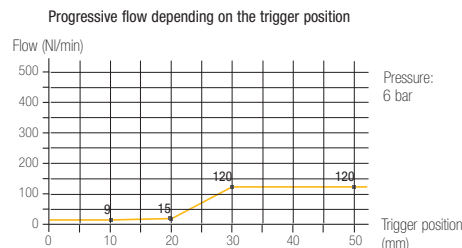
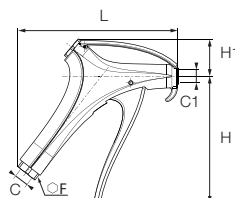

 120 Nl/min Flow produced with nozzle 0690 01 00  
 80 dBA Noise level measured without nozzle  
 OSHA 1910.242 (b): Depends on type of nozzle  
 OSHA 1910.95 (b)  
 2003/10/EC directive:  
 No ear defenders necessary

## 0652 Progressive Control Blowgun, Lower Connection with Interchangeable Nozzle, Female BSPP Thread



Technical polymer, nickel-plated brass, NBR

C	C1		F	H	H1	L	Kg
G1/4	M12x1.25	<b>0652 66 13</b>	20	117	34	147	0.163

Flow characteristics depend on the type of nozzle used.

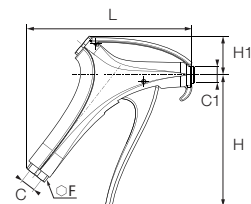
Delivered without nozzle.



 Depending on the type of nozzle  
 86 dBA Noise level measured without nozzle  
 OSHA 1910.242 (b): Depends on type of nozzle  
 OSHA 1910.95 (b)  
 2003/10/EC directive:  
 Requirement to use ear protection if exposure > 8 hours

## 0655 Progressive Control Blowgun, Upper Connection with Interchangeable Nozzle, Female BSPP Thread



Technical polymer, nickel-plated brass, NBR

C		F	H	H1	L	Kg
G1/4	<b>0655 66 13</b>	20	117	37	145	0.163

Flow characteristics depend on the type of nozzle used.

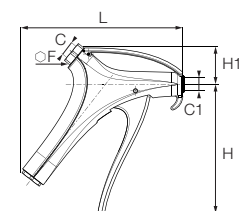
Delivered without nozzle.



 Depending on the type of nozzle  
 86 dBA Noise level measured without nozzle  
 OSHA 1910.242 (b): Depends on type of nozzle  
 OSHA 1910.95 (b)  
 2003/10/EC directive:  
 Requires ear defenders to be used when exposure is > 8 hours

# Polymer Blowguns

## 0651 Progressive Control Blowgun, Lower Connection with Standard Nozzle, Female BSPP Thread

Technical polymer, nickel-plated brass, NBR

C	DN		F	H	H1	L	L1	Kg
G1/4	2.5	<b>0651 66 13</b>	20	117	34	147	10	0.168

Nozzle: nickel-plated brass

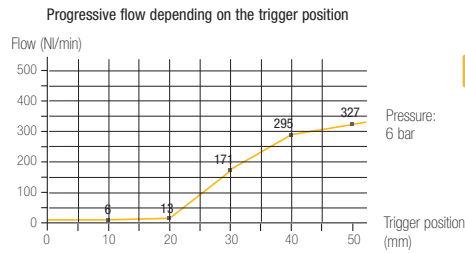
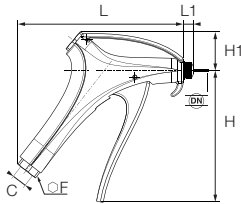

- 327 N/min Flow produced with nozzle **0690 01 00**
- 86 dBA
- Pressure: 6 bar
- OSHA 1910.95 (b) 2003/10/EC directive: Requirement to use ear protection if exposure > 8 hours

## 0658 Progressive Control Blowgun, Upper Connection with Standard Nozzle, Female BSPP Thread

Technical polymer, nickel-plated brass, NBR

C	DN		F	H	H1	L	L1	Kg
G1/4	2.5	<b>0658 66 13</b>	20	117	37	145	10	0.195

Nozzle: nickel-plated brass

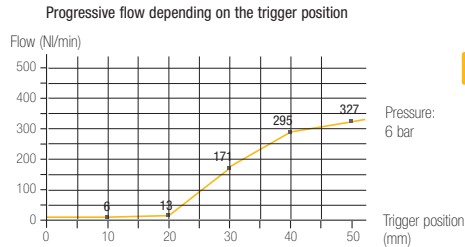
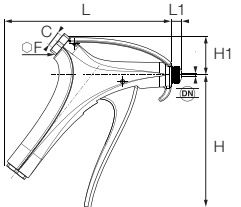

- 327 N/min Flow produced with nozzle **0690 01 00**
- 86 dBA
- Pressure: 6 bar
- OSHA 1910.95 (b) 2003/10/EC directive: Requirement to use ear protection if exposure > 8 hours

## 0656 Progressive Control Blowgun, Lower Connection with Short Angled Nozzle, Female BSPP Thread

Technical polymer, nickel-plated brass, NBR

C	DN		F	H	H1	L	L1	Kg
G1/4	2.5	<b>0656 66 13</b>	20	117	34	147	81	0.173

Nozzle: nickel-plated brass

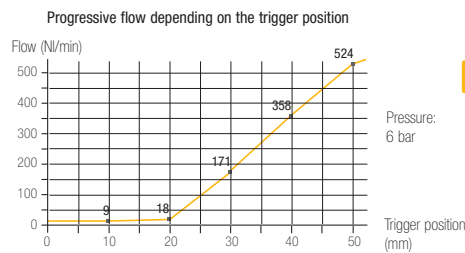
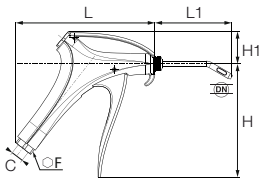

- 524 N/min Flow produced with nozzle **0690 06 01**
- 86 dBA
- Pressure: 6 bar
- OSHA 1910.242 (b) OSHA 1910.95 (b) 2003/10/EC directive: Requirement to use ear protection if exposure > 8 hours

## 0657 Safety Progressive Control Blowgun, Upper Connection with Short Angled Nozzle, Female BSPP Thread

Technical polymer, nickel-plated brass, NBR

C	DN		F	H	H1	L	L1	Kg
G1/4	2.5	<b>0657 66 13</b>	20	117	37	145	82	0.168

Nozzle: nickel-plated brass

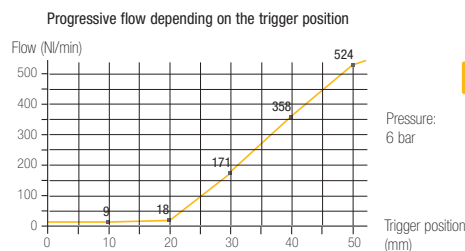
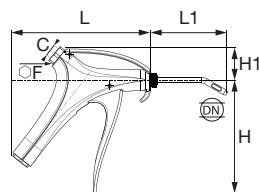

- 524 N/min Flow produced with nozzle **0690 06 01**
- 86 dBA
- Pressure: 6 bar
- OSHA 1910.242 (b) OSHA 1910.95 (b) 2003/10/EC directive: Requirement to use ear protection if exposure > 8 hours

# Merchandising Box of Polymer Blowguns

## 0659 Merchandising Box - 10 Standard Blowguns



0659 00 13 02

The box includes 10 blowguns 0659 00 13.

L	H	L1	Kg
28	16	20	1.720

## 0654 Merchandising Box - 10 Safety Blowguns



0654 00 13 02

The box includes 10 blowguns 0654 00 13.

L	H	L1	Kg
28	16	20	1.890

## 0654 Merchandising Box - 10 SUVA Safety Blowguns



0654 01 13 02

The box includes 10 blowguns 0654 01 13.

**suva**pro  
CERTIFICATION

L	H	L1	Kg
28	16	20	2.356

## 0653 Merchandising Box - 10 Energy-Saving Blowguns



0653 02 13 02

The box includes 10 blowguns 0653 02 13.

L	H	L1	Kg
28	16	20	1.900

## 0656 Merchandising Box - 10 Progressive Control Blowguns



0656 66 13 02

The box includes 10 blowguns 0656 66 13.

L	H	L1	Kg
28	16	20	1.730



# Nozzles for Polymer Blowguns

## 0690 01 Standard Nozzle

Nickel-plated brass

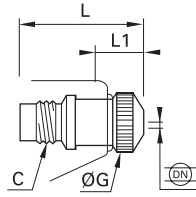

C	DN	G	L	L1	Kg	
M12x1.25	2.5	0690 01 00	15	31	9	0.023



327 Nl/min

86 dBA

23°

- Versatile use
- Progressive and powerful air jet

OSHA 1910.95 (b)  
2003/10/EC directive:  
Requirement to use ear protection  
if exposure > 8 hours

## 0690 02 Safety Nozzle

Nickel-plated brass

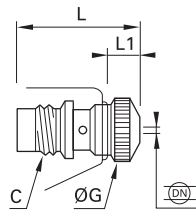

C	DN	G	L	L1	Kg	
M12x1.25	2.5	0690 02 00	15	31	9	0.024



315 Nl/min

83 dBA

26°

- Fluidised Powders
- Air screen effect
- Safety: avoids the nozzle becoming completely blocked

OSHA 1910.95 (b)/1910.242 (b)  
2003/10/EC directive:  
Requirement to use ear protection  
if exposure > 8 hours

## 0690 03 Straight Nozzle (Long)

Nickel-plated brass, NBR

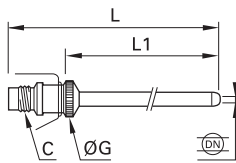

C	DN	G	L	L1	Kg	
M12x1.25	2.5	0690 03 00	15	332	307	0.068



386 Nl/min

82 dBA

21°

- Restricted access
- Progressive and powerful air jet

OSHA 1910.95 (b)  
2003/10/EC directive:  
Requirement to use ear protection  
if exposure > 8 hours

## 0690 04 Safety Straight Nozzle (Short)

Nickel-plated brass, NBR

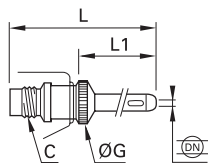

C	DN	G	L	L1	Kg	
M12x1.25	2.5	0690 04 00	15	102	77	0.033



410 Nl/min

82 dBA

21°

- Restricted access
- Air screen effect and directional jet
- Safety: avoids the nozzle becoming completely blocked

OSHA 1910.242 (b)/ OSHA 1910.95 (b)  
2003/10/EC directive:  
Requirement to use ear protection  
if exposure > 8 hours

## 0690 05 Angled Nozzle (Long)

Nickel-plated brass, NBR

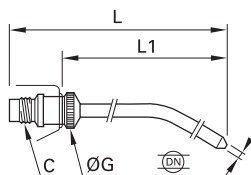

C	DN	G	L	L1	Kg	
M12x1.25	2.5	0690 05 00	15	316	292	0.065



354 Nl/min

82 dBA

21°

- Restricted or distant access
- Progressive and powerful air jet
- 360° rotation

OSHA 1910.95 (b)  
2003/10/EC directive:  
Requirement to use ear protection  
if exposure > 8 hours

# Nozzles for Polymer Blowguns

## 0690 06 Safety Angled Nozzle (Short)

Nickel-plated brass, NBR

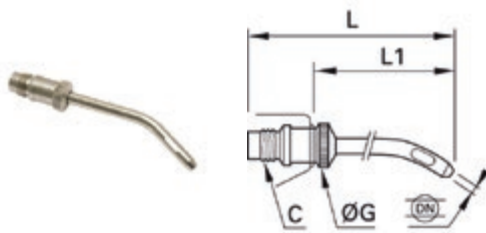

C	DN		G	L	L1	Kg
M12x1.25	2.5	0690 06 00	15	94	70	0.033



- Restricted access
- Air screen effect and 360° directional jet
- Safety: avoids the nozzle becoming completely blocked

350 NI/min

86 dBA

21°

OSHA 1910.242 (b)/ OSHA 1910.95 (b) 2003/10/EC directive: Requirement to use ear protection if exposure > 8 hours

## 0690 06 01 Angle Nozzle (Short)

Nickel-plated brass, NBR

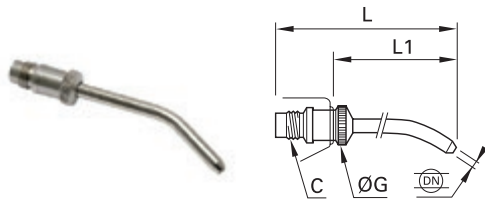

C	DN		G	L	L1	Kg
M12x1.25	2.5	0690 06 01	15	94	70	0.034



- Difficult access
- Progressive and powerful air jet, 360° rotation

524 NI/min

86 dBA

21°

OSHA 1910.95 (b) 2003/10/EC directive: Requirement to use ear protection if exposure > 8 hours

## 0690 07 Nozzle with LF 3000® Push-In Connection

Nickel-plated brass, NBR

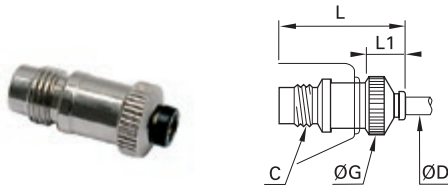

ØD	C		G	L	L1	Kg
4	M12x1.25	0690 07 00	15	35	13	0.024



- Restricted access
- Progressive air jet

340 NI/min (with 2.7x4 tube)  
200 NI/min (with 2x4 tube)

86 dBA

21°

OSHA 1910.95 (b) 2003/10/EC directive: Requirement to use ear protection if exposure > 8 hours

## 0690 09 Air Screen Safety Nozzle

Nickel-plated brass

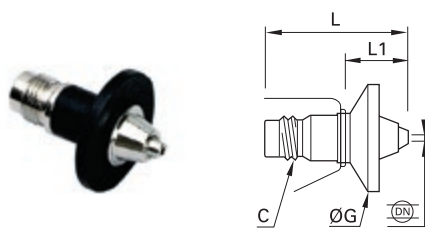

C	DN		G	L	L1	Kg
M12x1.25	2	0690 09 00	30	40.5	18.5	0.022

Deflector: technical polymer



- High flow for blowing large surfaces
- Air screen and deflector to avoid particles being blown back
- Safety: avoids the nozzle becoming completely blocked

660 NI/min

86 dBA

24° nozzle  
140° screen

OSHA 1910.242 (b)/ OSHA 1910.95 (b) 2003/10/EC directive: Requirement to use ear protection if exposure > 8 hours

## 0690 08 COANDA Nozzle

Nickel-plated brass



C		L	L1	Kg
M12x1.25	0690 08 00	47.5	26	0.033



- Directional air jet
- Very quiet, energy-saving
- Safety: avoids the nozzle becoming completely blocked

240 NI/min

73 dBA

20°

OSHA 1910.242 (b)/ OSHA 1910.95 (b) 2003/10/EC directive: No ear defenders necessary



# Nozzles for Polymer Blowguns

## 0690 10

### Safety Booster Nozzle

Nickel-plated brass

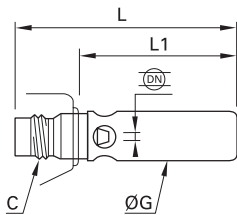

C	DN		G	L	L1	Kg
M12x1.25	2.5	<a href="#">0690 10 00</a>	15	64	42	0.038

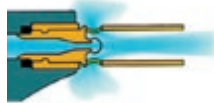

- High flow for blowing large surfaces
- Air screen effect
- Safety: avoids the nozzle becoming completely blocked

780 Nl/min

99 dBA

28°

OSHA 1910.242 (b)  
2003/10/EC directive:  
Requires ear defenders to be used at all times

## 0690 11

### Safety Booster Nozzle with Air Screen

Nickel-plated brass

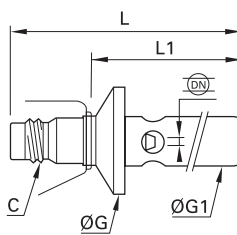

C	DN		G	G1	L	L1	Kg
M12x1.25	2.5	<a href="#">0690 11 00</a>	30	15	76	54	0.046

Deflector: technical polymer



- Same advantage as the Booster nozzle
- Safety: avoids the nozzle becoming completely blocked
- Air screen and deflector avoid particles being blown back

860 Nl/min

99 dBA

26° nozzle  
140° screen

OSHA 1910.242 (b)  
2003/10/EC directive:  
Requires ear defenders to be used at all times

# Metal Blowguns and Water Pistols

This range of robust blowguns guarantees a **longer service life** under **severe conditions** (crushing, impact, shock and corrosion). It includes two versions **to meet all requirements** for blowing and spraying in industrial applications.

## Product Advantages

**Workshop Blowgun** | Compact for easy incorporation into compressed air ring mains  
Nickel-plated forged brass for increased corrosion resistance

**Water Pistol** | Intended for the transmission of water and fluids  
Designed for precise flow control and optimisation of the power and shape of the jet  
Optimum use of industrial fluids  
Excellent ergonomics and service life



**Applications**

- Manufacturing Workshops
- Assembly Machines
- Robotics
- Ejection
- Cooling
- Packaging
- Automotive Process

## Technical Characteristics

Model	Metal Blowgun	Water Pistol
Compatible Fluids	Compressed air, industrial fluids	Water, oil, industrial fluids
Working Pressure	0 to 10 bar	0 to 20 bar
Working Temperature	Air: -15°C to +50°C Dry air: -20°C to +80°C	-20°C to +100°C
Tubes	Recoil tubes and hose	Braided hose with Parker Legris couplers

### Component Materials

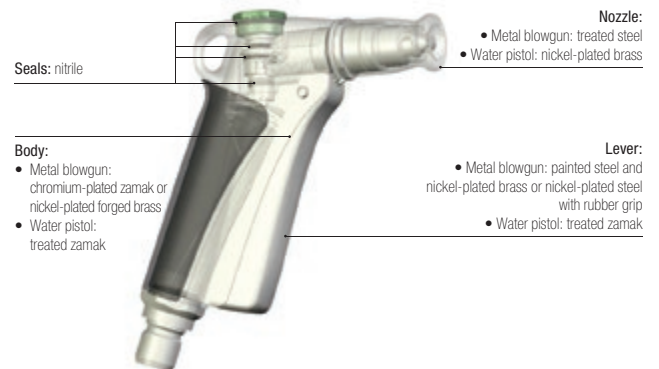

### Silicone-free

### Regulations

Compliance for all blowguns:  
 DI: 97/23/EC (PED)  
 DI: 2002/95/EC (RoHS), 2011/65/EC  
 DI: 1907/2006 (REACH)

# Metal Blowguns and Water Pistols

## 0623 Lever-Operated Blowgun, Female BSPP Thread

Nickel-plated brass, zinc-plated blister steel, NBR

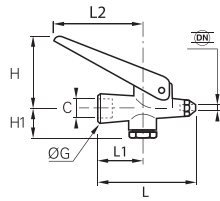

C	DN		G	H min	H max	H1	L	L1	L2	Kg
G1/4	2		18	19	37	21	64	28	60	0.119

This blowgun has a hardened steel nozzle.

## 0622 Button-Operated Blowgun, Female BSPP Thread

Nickel-plated brass, zinc-plated blister steel, NBR

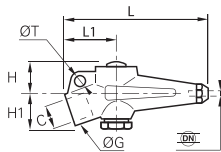

C	DN		G	H	H1	L	L1	ØT	Kg
G1/4	2		18	17.5	20.5	82	29	7	0.199

This blowgun has a hardened steel nozzle.

## 2299 Water Pistol

Zamak, nickel-plated brass, NBR

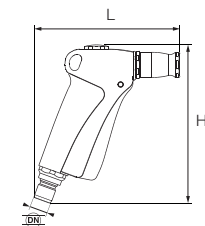

DN		H	L	Kg
12		140	126	0.468

This pistol allows independent control of:

- the flow rate (trigger)
- type of jet (adjustable to a fine mist) by the adjustable nozzle

1440 Nl/min (air)  
16.2 Nl/min (eau)

Adjustable

## 2299 Adjustable Nozzle

Nickel-plated brass, NBR

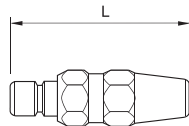

DN		L	Kg
12		77.4	0.137

This nozzle allows adjustment of the spray.

### Related Products

For optimum connection and usage of the pistol and adjustable nozzle, you will find a full range of quick-acting couplers, in the Midi and Maxi Series, in Chapter 8.

Midi P. 8-25



Maxi P. 8-29



# Blowgun Kits

**Ready for use**, **simple** and **ergonomic**, the Parker Legris blowgun kit remains an essential item of equipment for any blowing or spraying operation in the industrial environment.

## Product Advantages

### Ready for Use

- Kit contents:
- one blowgun
  - a 4 metre recoil tube
  - one R1/4 threaded fitting, external diameter 8 mm
- Easy to install and comfortable to use  
 Wide range of models and nozzles for optimum flow  
 Lower or upper connection  
 Labelling and colours can be customised  
 Packaging designed to facilitate self-service sales

### Safety & Performance

- Safe operation with the Safety or OSHA models  
 Durable, shock-resistant materials  
 100% leak and flow-tested in production  
 Date coding to guarantee quality and traceability  
 Minimum pressure drop  
 Optimisation of your energy consumption with the Energy-Saving model



Manufacturing Workshops  
 Cleaning  
 Blowing  
 Mixing  
 Ejection  
 Cooling  
 Packaging

**Applications**

## Technical Characteristics

<b>Compatible Fluids</b>	Compressed air Other fluids: contact us
<b>Working Pressure</b>	0 to 10 bar
<b>Working Temperature</b>	Air: -15°C to +50°C Dry air: -20°C to +80°C
<b>Tubes</b>	Recoil tubing

### Regulations

#### Compliance for all blowguns:

DI: 97/23/EC (PED)  
 DI: 2002/95/EC (RoHS), 2011/65/EC  
 DI: 1907/2006 (REACH)

#### Protection of design

All designs and models of Parker Legris blowguns have been registered with the following numbers: 13224 / 13225 / 13226.

#### Compliance for specific blowguns:

DI: 1910.242 (b) [OSHA]  
 The static pressure must be less than 30 psi in case the nozzle becomes blocked.  
 DI: 1910.95 (b) [OSHA]  
 The noise level must be less than 90 dBA over 8 hours' exposure.  
 DI: 2003/10/EC  
 Regulation relating to exposure to noise, particularly with regard to risks to hearing. The noise level must be less than 87 dBA.

### Component Materials

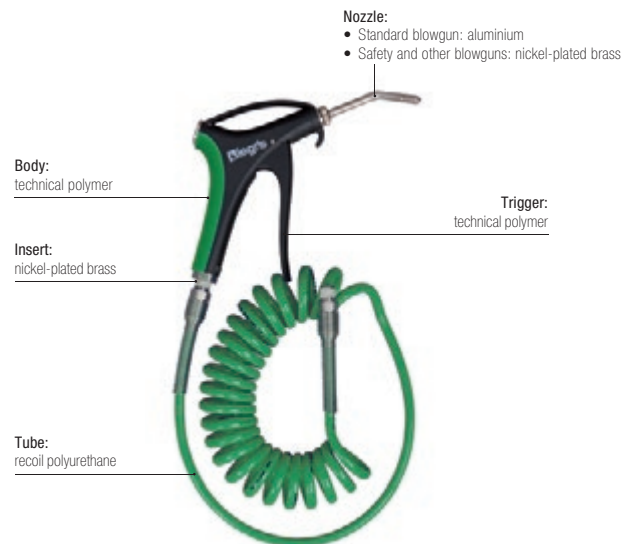

### Silicone-free

## Customisation on request

- Marking
- Kit contents adaptable to your applications
- Additional functions
- Colour



# Blowgun Kits

## 0631..09 Blowgun Kit, Lower Connection, Female BSPT Thread

Technical polymer, nickel-plated brass, treated aluminium, NBR

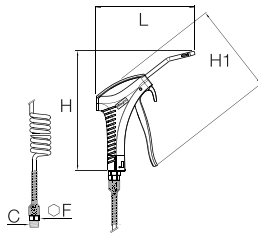

C		F	H	H1	L	Kg
R1/4	<b>0631 00 09</b>	16	192.5	139.5	152	0.441

Flow characteristics, noise level and norm compliance are identical to those of our blowguns (0659 00 13).

## 0631..01 Safety Blowgun Kit, Lower Connection, Male BSPT Thread

Technical polymer, nickel-plated brass, NBR

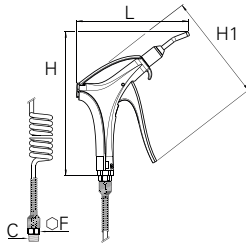

C		F	H	H1	L	Kg
R1/4	<b>0631 00 01</b>	16	198.5	148.5	154	0.575

Flow characteristics, noise level and norm compliance are identical to those of our blowguns (0654 00 13).

## 0631..30 Safety Blowgun, Lower Connection, Female BSPP Thread

Technical polymer, nickel-plated brass, NBR

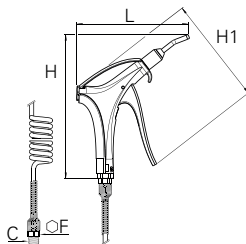

C		F	H	H1	L	Kg
R1/4	<b>0631 00 30</b>	16	198.5	148.5	154	0.575

Nozzle: nickel-plated brass, NPT version available.

Flow characteristics, noise level and norm compliance are identical to those of our blowguns (0654 01 13).

**suva**  
pro  
CERTIFICATION

## 0631..23 Energy Saving Blowgun Kit with Angled Nozzle, Male BSPT Thread

Technical polymer, nickel-plated brass, NBR

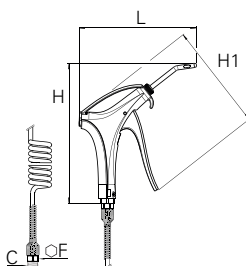

C		F	H	H1	L	Kg
R1/4	<b>0631 00 23</b>	16	195	148.5	163	0.456

Flow characteristics, noise level and norm compliance are identical to those of our blowguns (0653 66 13).

External diameter of tube 6 mm

# Blowgun Kits

## 0631..03 Blowgun Kit, Lower Connection with Standard Nozzle, Male BSPT Thread

Technical polymer, nickel-plated brass, NBR

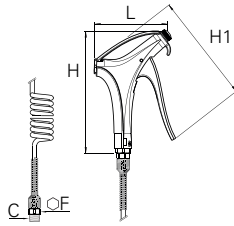

C		F	H	H1	L	Kg
R1/4	<b>0631 00 03</b>	16	165	148.5	99	0.528

Flow characteristics, noise level and norm compliance are identical to those of our blowguns (0651 66 13).

## 0631..02 Blowgun Kit, Upper Connection with Standard Nozzle, Male BSPT Thread

Technical polymer, nickel-plated brass, NBR

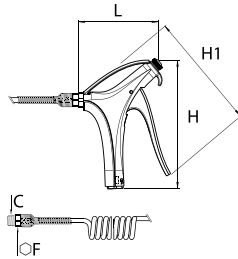

C		F	H	H1	L	Kg
R1/4	<b>0631 00 02</b>	16	163	148.5	101	0.524

Flow characteristics, noise level and norm compliance are identical to those of our blowguns (0658 66 13).

## 0631..04 Blowgun Kit, Upper Connection with Short Angled Nozzle, Male BSPT Thread

Technical polymer, nickel-plated brass, NBR

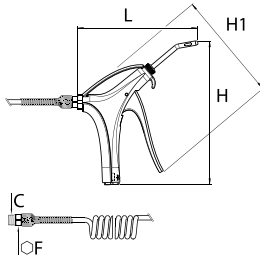

C		F	H	H1	L	Kg
R1/4	<b>0631 00 04</b>	16	195	148.5	163.5	0.536

Flow characteristics, noise level and norm compliance are identical to those of our blowguns (0657 66 13).

## 0631..05 Blowgun Kit Lower Connection with Short Angled Nozzle, Male BSPT Thread

Technical polymer, nickel-plated brass, NBR

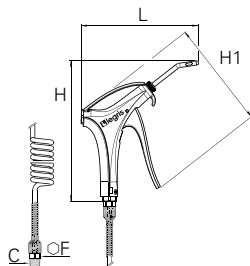

C		F	H	H1	L	Kg
R1/4	<b>0631 00 05</b>	16	195.5	148.5	163	0.536

Flow characteristics, noise level and norm compliance are identical to those of our blowguns (0656 66 13).

# Blowgun Kits

## 0631..07 Blowgun Kit, Lower Connection with Interchangeable Nozzle, Male BSPT Thread

Technical polymer, nickel-plated brass, NBR

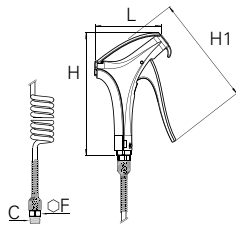

C		F	H	H1	L	Kg
R1/4	<b>0631 00 07</b>	16	163	148.5	91	0.617

Flow characteristics, noise level and norm compliance are identical to those of our blowguns (0656 66 13).  
Delivered without nozzle.

## 0631..06 Blowgun Kit, Upper Connection with Interchangeable Nozzle, Male BSPT Thread

Technical polymer, nickel-plated brass, NBR

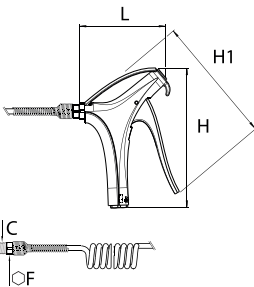

C		F	H	H1	L	Kg
R1/4	<b>0631 00 06</b>	16	161.5	148.5	93	0.501

Flow characteristics, noise level and norm compliance are identical to those of our blowguns (0655 66 13).  
Delivered without nozzle.

## 0631..08 Energy Saving Blowgun Kit, Lower Connection, Interchangeable Nozzle, Male BSPT Thread

Technical polymer, nickel-plated brass, NBR

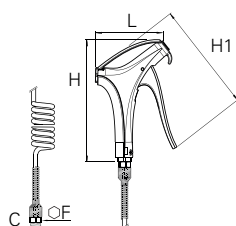

C		F	H	H1	L	Kg
R1/4	<b>0631 00 08</b>	16	163	148.5	91	0.496

Flow characteristics, noise level and norm compliance are identical to those of our blowguns (0653 66 13).  
Delivered without nozzle.







# Quick-Acting Couplers

**Polymer Safety, C 9000**

**Metal**

**Quick-Acting Couplers Accessories**

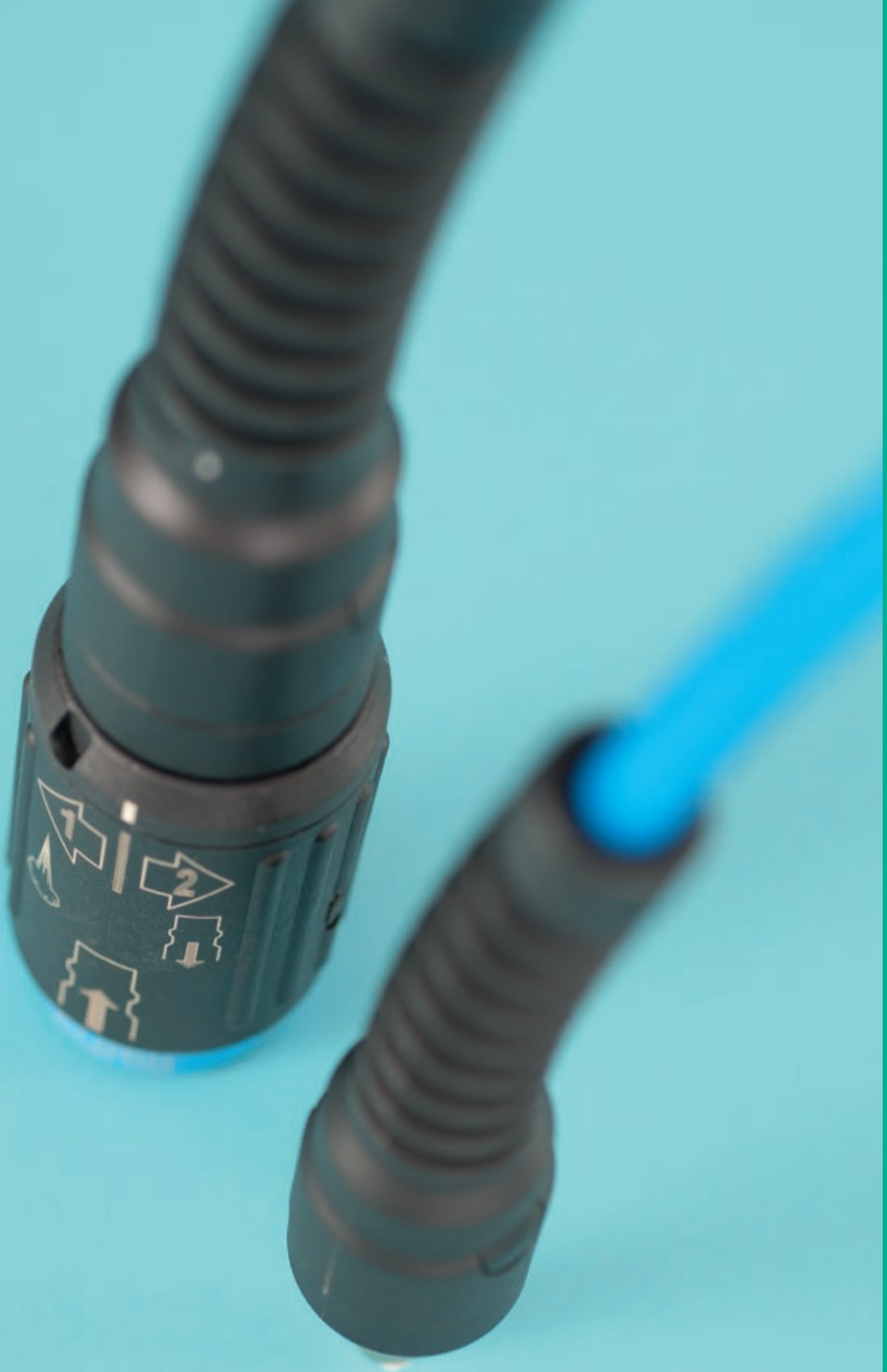

# Quick-Acting Couplers

## C 9000 Polymer Quick-Acting Safety Couplers (P. 8-7)



**Fluids:** compressed air

**Materials:** reinforced technical polymer, nickel-plated brass

**Pressure:** 16 bar

**Temperature:** -20°C to +60°C

**DN** : 5.5 mm to 8 mm

## Metal Quick-Acting Couplers (P. 8-19)



**Fluids:** compressed air, water, industrial fluids

**Materials:** nickel-plated brass

**Pressure:** 20 bar

**Temperature:** -20°C to +100°C

**DN** : 2 mm to 19 mm

## Metal Quick-Acting Couplers Accessories (P. 8-30)



**Fluids:** industrial fluids

**Materials:** brass or nickel-plated brass

**Pressure:** 20 bar

**Temperature:** -5°C to +60°C

**DN** : 5,5 mm to 8 mm

## 3 Shut-Off Functions

### Straight-Through

These couplers work without shut-off, meaning they offer maximum flow. Straight-Through couplers are designed to carry fluids such as water, coolants, etc. Before disconnection, the fluid flow must be shut off using a valve located upstream of the coupler.

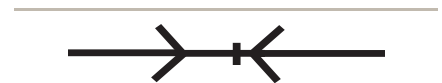

### Single Shut-Off (with or without vent)

On our single shut-off couplers, the male probe is straight-through. The fluid flow can be stopped in the female coupler when disconnected. The circuit can be vented upstream to avoid any risk of whiplash.

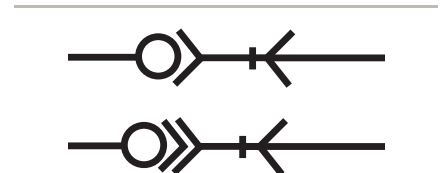

### Double Shut-Off

On our double shut-off couplers, after disconnection, flow is prevented both upstream of the female coupler and downstream of the probe. Both sides of the circuit remain under pressure.

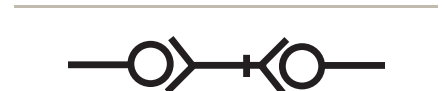

# Technology and Flow Rates

The profiles of the Parker Legris quick-acting couplers are manufactured to conform to international standards and are interchangeable with other manufacturers' products meeting these standards.

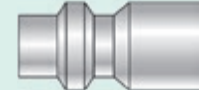
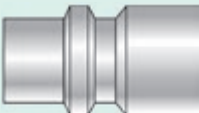
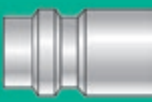
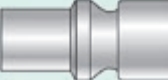
Profile Description	Profile	Interchangeability	Flow (NI/min)	Bore Diameter (mm)
<b>ISO B Standard</b>		C 9000	1250	5.5
		C 9000	2400	8
<b>European Standard</b>		C 9000	2000	7.2
<b>ARO Standard</b>		C 9000	1250	5.5

# Quick-Acting Coupler Part Numbers

Standard Product

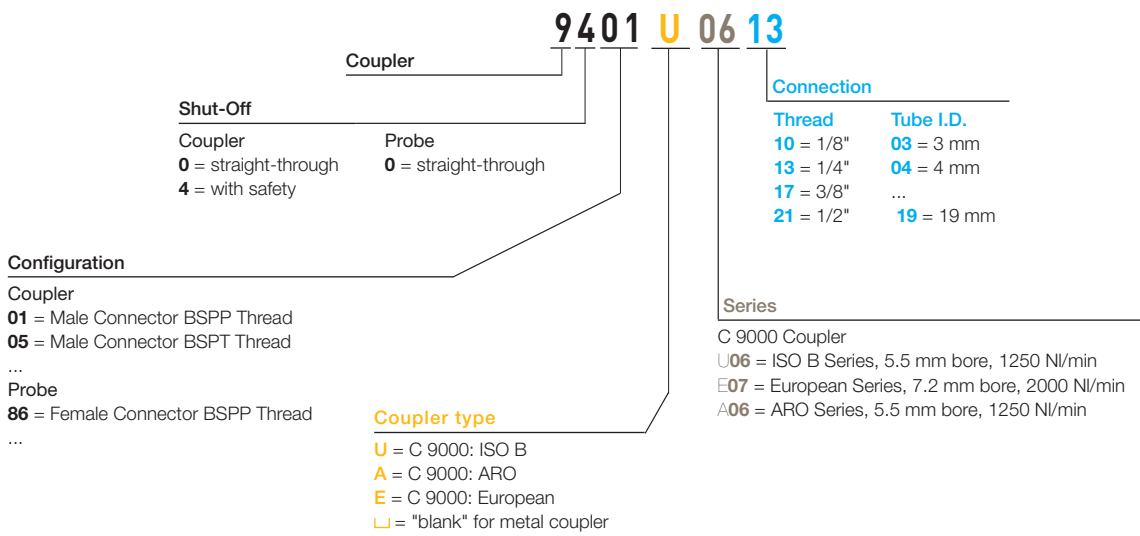

# C 9000 Polymer Quick-Acting Safety Coupler Range

## C 9000 Polymer Quick-Acting Safety Couplers

### ISO B Profile

**9401U** Page 8-10   **9405U** Page 8-10   **9414U** Page 8-10   **9410U** Page 8-10   **9421U** Page 8-10   **9416U** Page 8-11   **9440U** Page 8-11



**9087U** Page 8-11   **9086U** Page 8-11   **9080U** Page 8-12   **9094U** Page 8-12



### European Profile

**9401E** Page 8-13   **9414E** Page 8-13   **9410E** Page 8-13   **9421E** Page 8-13   **9416E** Page 8-13   **9440E** Page 8-14



**9087E** Page 8-14   **9086E** Page 8-14   **9080E** Page 8-14   **9094E** Page 8-14



### ARO Profile

**9401A** Page 8-15   **9405A** Page 8-15   **9414A** Page 8-15   **9410A** Page 8-15   **9421A** Page 8-15   **9416A** Page 8-16   **9440A** Page 8-16



**9087A** Page 8-16   **9086A** Page 8-16   **9084A** Page 8-16   **9080A** Page 8-17   **9094A** Page 8-17



# C 9000 Polymer Quick-Acting Safety Couplers

This range of ergonomic polymer couplers has been designed for **the safety of operators and machinery** while giving very high **energy efficiency performance**. Available in three profile standards, it is perfectly suited for any type of installation.

## Product Advantages

- |                                 |  |
|---------------------------------|--|
| <b>Safety &amp; Reliability</b> | <ul style="list-style-type: none"> <li>Prevents risk of whiplash</li> <li>Quick-acting vent allowing disconnection to be carried out in total safety</li> <li>Rotating sleeve to avoid risk of accidental disconnection</li> <li>Low connection/disconnection force even under pressure</li> <li>Polymer sleeve protects equipment from scratching</li> <li>Protective spiral over the tube prevents kinking</li> </ul>  |
| <b>Performance</b>              | <ul style="list-style-type: none"> <li>Very high flow and low pressure drop</li> <li>100% leak-tested in production</li> <li>Date coding to guarantee quality and traceability</li> <li>Robust impact-resistant material</li> <li>Optimum energy efficiency</li> <li>Long-term reliability</li> </ul>  |
| <b>Easy-to-Use</b>              | <ul style="list-style-type: none"> <li>Immediate identification by clear marking on each model showing:                             <ul style="list-style-type: none"> <li>• profile of the compatible male probe</li> <li>• type part number</li> </ul> </li> <li>Compatible with male probes conforming to:                             <ul style="list-style-type: none"> <li>• ISO B profile</li> <li>• European profile</li> <li>• ARO profile</li> </ul> </li> </ul> |



- Applications**
- Workshops
  - Cleaning
  - Blowing
  - Pneumatics
  - Air-Operated Tools
  - Ring Main Circuits
  - Packaging

## Technical Characteristics

<b>Compatible Fluids</b>	Compressed air
<b>Working Pressure</b>	0 to 16 bar
<b>Working Temperature</b>	-20°C to +60°C

### Component Materials

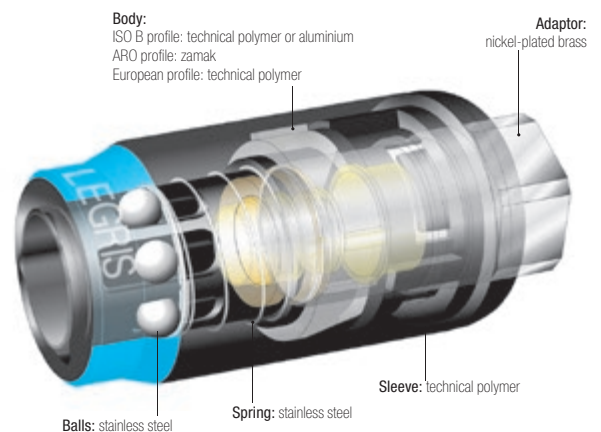

**Silicone-free**

### Regulations

- DI: 97/23/EC (PED)
- DI: 2002/95/EC (RoHS), 2011/65/EC
- DI: 1907/2006 (REACH)
- ISO 4414 Pneumatic Fluid Power: General Rules Relating to Systems
- DIN EN 983 Safety Standard for Pneumatics



# C 9000 Polymer Quick-Acting Safety Couplers

## C 9000 Technology and Flow Rates

"Typical" quick-acting coupler  
Standard "poppet" technology  
Flow: 1400 NI/min

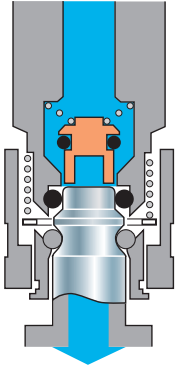

C 9000 quick-acting coupler  
"Optimal flow" technology  
Flow: 2400 NI/min

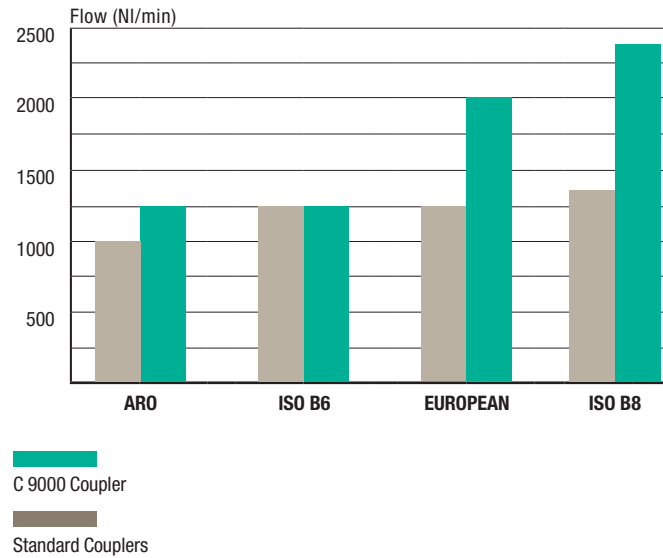
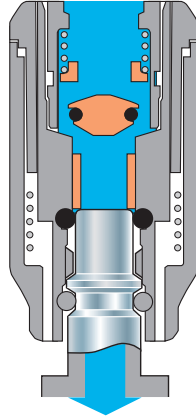

Measurements carried out in accordance with ISO 6358 at a pressure of 6 bar, pressure drop < 0.7 bar

## Operation

### Operation

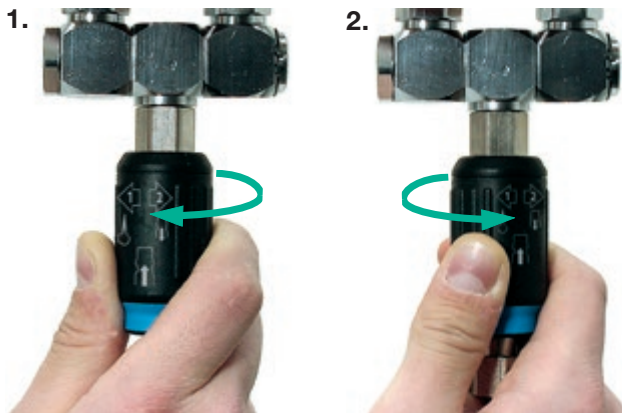

Disconnecting the probe

Rotation, arrow 1: circuit vented on probe side.

Rotation, arrow 2: probe disconnected from the body.

Connecting the probe

The sleeve does not need to be rotated to connect the probe.

### Venting Time



ISO B6 profile, recoil tubing (I.D. 6 mm, length 6 m)

Venting time = 350 ms (transition from 6 bar to 0.2 bar)

ISO B8 profile, PVC tubing (I.D. 10 mm, length 25 m)

Venting time = 860 ms (transition from 6 bar to 0.2 bar)

Even with longer lengths of tubing, the vent time of the C 9000 coupler can be less than 1 second.

# ISO B Profile

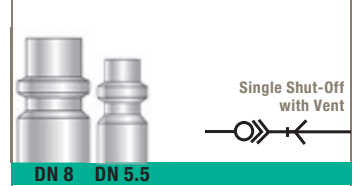

## 9401U Coupler, Male BSPP Thread

Technical polymer, nickel-plated brass, NBR

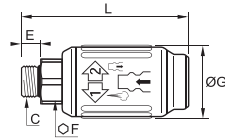

DN	C		E	F	G	L	Kg
5.5	G1/4	9401U06 13	7.5	17	31.5	74	0.075
	G3/8	9401U06 17	8.5	21	31.5	76.5	0.095
	G1/2	9401U06 21	10.5	25	31.5	80	0.115
8	G1/4	9401U08 13	6.5	22	36.5	81.5	0.120
	G3/8	9401U08 17	7.5	22	36.5	82.5	0.133
	G1/2	9401U08 21	9	25	36.5	85.5	0.140

C 9000 Series ISO B (DN 5.5): single shut-off = 1250 NI/min

C 9000 Series ISO B (DN 8): single shut-off = 2400 NI/min

## 9405U Coupler, Male BSPT Thread

Technical polymer, nickel-plated brass, NBR

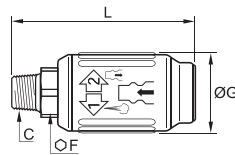

DN	C		F	G	L	Kg
5.5	R1/4	9405U06 13	17	31.5	75	0.075
	R3/8	9405U06 17	19	31.5	76.5	0.095
	R1/2	9405U06 21	22	31.5	81.5	0.110
8	R1/4	9405U08 13	22	36.5	84	0.120
	R3/8	9405U08 17	22	36.5	84	0.120
	R1/2	9405U08 21	22	36.5	88	0.140

C 9000 Series ISO B (DN 5.5): single shut-off = 1250 NI/min

C 9000 Series ISO B (DN 8): single shut-off = 2400 NI/min

## 9414U Coupler, Female BSPP Thread

Technical polymer, nickel-plated brass, NBR

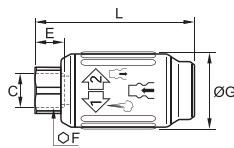

DN	C		E	F	G	L	Kg
5.5	G1/4	9414U06 13	12	17	31.5	66.5	0.070
	G3/8	9414U06 17	12	22	31.5	72	0.085
	G1/2	9414U06 21	15	27	31.5	78	0.115
8	G1/4	9414U08 13	12	22	36.5	75	0.127
	G3/8	9414U08 17	12	22	36.5	75	0.144
	G1/2	9414U08 21	15	27	36.5	80	0.138

C 9000 Series ISO B (DN 5.5): single shut-off = 1250 NI/min

C 9000 Series ISO B (DN 8): single shut-off = 2400 NI/min

## 9410U Coupler, LF 3000® Push-In Connection, Body Spiral Protection Spring

Technical polymer, nickel-plated brass, NBR

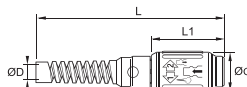

DN	ØD		G	L	L1	Kg
5.5	8	9410U06 08	31.5	145	56	0.096
	10	9410U06 10	31.5	145	56	0.080
8	10	9410U08 10	36.5	155	63	0.175
	12	9410U08 12	36.5	165	63	0.162

C 9000 Series ISO B (DN 5.5): single shut-off = 1250 NI/min

C 9000 Series ISO B (DN 8): single shut-off = 2400 NI/min

## 9421U Coupler with Hosetail

Technical polymer, nickel-plated brass, NBR

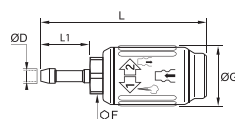

DN	ØD		F	G	L	L1	Kg
5.5	6	9421U06 06	17	31.5	88.5	26	0.070
	8	9421U06 08	17	31.5	88.5	26	0.070
	10	9421U06 10	17	31.5	88.5	26	0.070
8	6	9421U08 06	22	36.5	95	26	0.110
	8	9421U08 08	22	36.5	95	26	0.100
	10	9421U08 10	22	36.5	95	26	0.124
	13	9421U08 13	22	36.5	99	30	0.125

C 9000 Series ISO B (DN 5.5): single shut-off = 1250 NI/min

C 9000 Series ISO B (DN 8): single shut-off = 2400 NI/min

# ISO B Profile

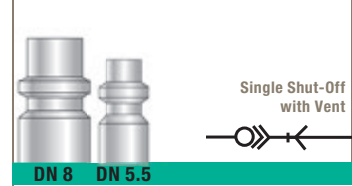

## 9416U Coupler, Bulkhead Mountable, Female BSPP Thread

Technical polymer, nickel-plated brass, NBR

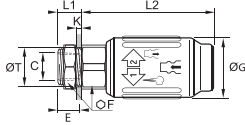

DN	C		E	F	G	K <sub>max</sub>	L1	L2	ØT <sub>min</sub>	Kg
5.5	G1/4	<a href="#">9416U06 13</a>	12	22	31.5	6	12.5	68.5	18.5	0.105
8	G3/8	<a href="#">9416U08 17</a>	12	24	36.5	7	14.5	76	22.5	0.150

C 9000 Series ISO B (DN 5.5): single shut-off = 1250 NI/min

C 9000 Series ISO B (DN 8): single shut-off = 2400 NI/min

## 9440U Y Coupler, Female BSPP Thread

Technical polymer, nickel-plated brass, NBR

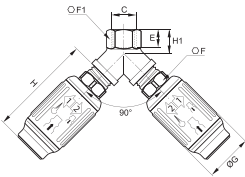

DN	C		E	F	F1	G	H	H1	Kg
5.5	G3/8	<a href="#">9440U06 17</a>	11.5	19	20	31.5	70	16	0.207
8	G1/2	<a href="#">9440U08 21</a>	14	22	25	36.5	80	19	0.352

C 9000 Series ISO B (DN 5.5): single shut-off = 1250 NI/min

C 9000 Series ISO B (DN 8): single shut-off = 2400 NI/min

## 9087U Probe, Straight-Through, Male BSPP Thread

Nickel-plated steel, technical polymer

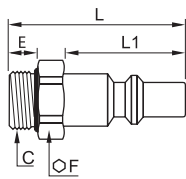

DN	C		E	F	L	L1	Kg
5.5	G1/4	<a href="#">9087U06 13</a>	9	13	39	24	0.026
	G3/8	<a href="#">9087U06 17</a>	9	17	38	24	0.032
	G1/2	<a href="#">9087U06 21</a>	9	19	39	24	0.048
8	G1/4	<a href="#">9087U08 13</a>	9	17	38	24	0.030
	G3/8	<a href="#">9087U08 17</a>	9	19	39	24	0.036
	G1/2	<a href="#">9087U08 21</a>	12	22	42	24	0.058

Probe without shut-off

## 9086U Probe, Straight-Through, Female BSPP Thread

Treated steel

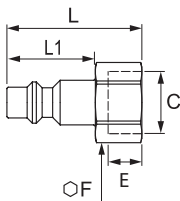

DN	C		E	F	L	L1	Kg
5.5	G1/4	<a href="#">9086 23 13</a>	9	17	36	24	0.025
	G3/8	<a href="#">9086 23 17</a>	9	19	36	24	0.025
	G1/2	<a href="#">9086 23 21</a>	12	24	39	24	0.039

Probe without shut-off

## 9086U Probe, Straight-Through, Female BSPP Thread

Nickel-plated steel

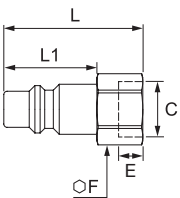

DN	C		E	F	L	L1	Kg
8.5	G1/4	<a href="#">9086 30 13</a>	10	17	40	28	0.032
	G3/8	<a href="#">9086 30 17</a>	10	19	42	28	0.035
	G1/2	<a href="#">9086 30 21</a>	12	24	43	28	0.046

Probe without shut-off

C 9000 Series probe (DN 8.5) compatible with ISO B Series C 9000 couplers (DN 8)

# ISO B Profile

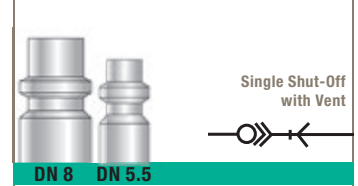

## 9080U Probe, Straight-Through, LF 3000® Push-In Connection, with Spiral Protection Spring

Nickel-plated steel, NBR

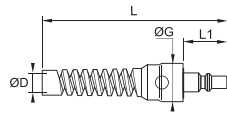

DN	ØD		G	L	L1	Kg
5.5	8	<a href="#">9080U06 08</a>	24	112	24	0.052
	10	<a href="#">9080U06 10</a>	24	112	24	0.044
8	10	<a href="#">9080U08 10</a>	24	114	26	0.095
	12	<a href="#">9080U08 12</a>	29.5	125	26	0.096

Probe without shut-off

## 9094U Probe, Straight-Through, with Hosetail

Nickel-plated steel

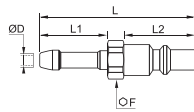

DN	ØD		F	L	L1	L2	Kg
5.5	6	<a href="#">9094U06 06</a>	14	51	24	25	0.016
	8	<a href="#">9094U06 08</a>	14	51	27	25	0.017
	10	<a href="#">9094U06 10</a>	14	51	24	25	0.018
8	8	<a href="#">9094U08 08</a>	17	51	24	25	0.027
	10	<a href="#">9094U08 10</a>	17	51	27	25	0.028
	13	<a href="#">9094U08 13</a>	17	51	24	25	0.031

Probe without shut-off

# European Profile

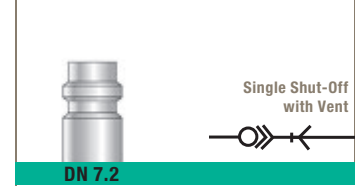

## 9401E Coupler, Male BSPP Thread

Technical polymer, nickel-plated brass, NBR

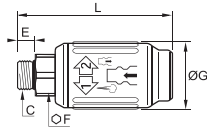

DN	C		E	F	G	L	Kg
7.2	G1/4	9401E07 13	6.5	22	36.5	80	0.124
	G3/8	9401E07 17	7.5	22	36.5	81	0.122
	G1/2	9401E07 21	9	25	36.5	83.5	0.136

C 9000 Series: single shut-off = 2000 NI/min

## 9414E Coupler, Female BSPP Thread

Technical polymer, nickel-plated brass, NBR

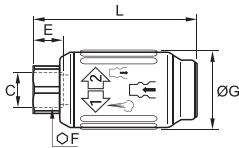

DN	C		E	F	G	L	Kg
7.2	G1/4	9414E07 13	12	22	36.5	73	0.118
	G3/8	9414E07 17	12	22	36.5	73	0.109
	G1/2	9414E07 21	15	27	36.5	78	0.130

C 9000 Series: single shut-off = 2000 NI/min

## 9410E Coupler, LF 3000® Push-In Connection, with Spiral Protection Spring

Technical polymer, nickel-plated brass, NBR

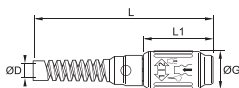

DN	ØD		G	L	L1	Kg
7.2	10	9410E07 10	36.5	151	63	0.175
	12	9410E07 12	36.5	151	63	0.180

C 9000 Series: single shut-off = 2000 NI/min

## 9421E Coupler with Hosetail

Technical polymer, nickel-plated brass, NBR

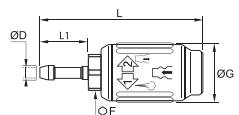

DN	ØD		F	G	L	L1	Kg
7.2	8	9421E07 08	22	36.5	93	26	0.113
	10	9421E07 10	22	36.5	93	26	0.114
	13	9421E07 13	22	36.5	97	30	0.119

C 9000 Series: single shut-off = 2000 NI/min

## 9416E Coupler, Bulkhead Mountable, Female BSPP Thread

Technical polymer, nickel-plated brass, NBR

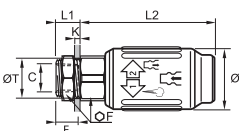

DN	C		E	F	G	K <sub>max</sub>	L1	L2	ØT <sub>min</sub>	Kg
7.2	G3/8	9416E07 17	12	24	36.5	7	14.5	74	22.5	0.153

C 9000 Series: single shut-off = 2000 NI/min

# European Profile

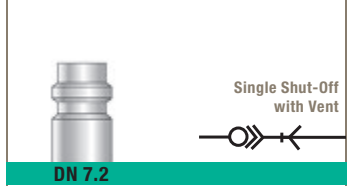

## 9440E Y Coupler, Female BSP Thread

Technical polymer, nickel-plated brass, NBR

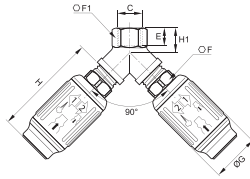

DN	C		E	F	F1	G	H	H1	Kg
7.2	G1/2	<a href="#">9440E07 21</a>	14	25	25	36.5	78	19	0.335

C 9000 Series: single shut-off = 2000 NI/min

## 9087E Probe, Straight-Through, Male BSP Thread

Nickel-plated steel, technical polymer

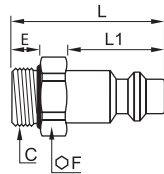

DN	C		E	F	L	L1	Kg
7.2	G1/4	<a href="#">9087E07 13</a>	9	14	34	20	0.018
	G3/8	<a href="#">9087E07 17</a>	9	17	34	20	0.025
	G1/2	<a href="#">9087E07 21</a>	12	22	38	20	0.048

Probe without shut-off

## 9086E Probe, Straight-Through, Female BSP Thread

Nickel-plated steel

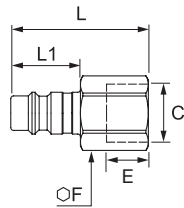

DN	C		E	F	L	L1	Kg
7.4	G1/8	<a href="#">9086 25 10</a>	7	14	32	20	0.016
	G1/4	<a href="#">9086 25 13</a>	9	17	38.5	20	0.027
	G3/8	<a href="#">9086 25 17</a>	9	19	33	20	0.027
	G1/2	<a href="#">9086 25 21</a>	12	24	36	20	0.048

Probe without shut-off

## 9080E Probe, Straight-Through, LF 3000® Push-In Connection, with Spiral Protection Spring

Nickel-plated steel, NBR

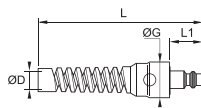

DN	ØD		G	L	L1	Kg
7.2	10	<a href="#">9080E07 10</a>	24	114	20	0.102
	12	<a href="#">9080E07 12</a>	29.5	125	20	0.088

Probe without shut-off

## 9094E Probe, Straight-Through, with Hosetail

Nickel-plated steel

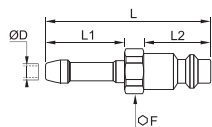

DN	ØD		F	L	L1	L2	Kg
7.2	8	<a href="#">9094E07 08</a>	17	48	20	25	0.015
	10	<a href="#">9094E07 10</a>	17	48	20	25	0.016
	13	<a href="#">9094E07 13</a>	17	48	20	25	0.020

Probe without shut-off

# ARO Profile

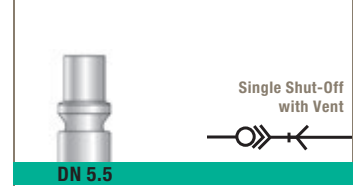

## 9401A Coupler, Male BSPP Thread

Technical polymer, nickel-plated brass, NBR

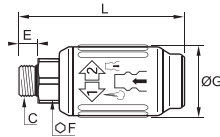

DN	C		E	F	G	L	Kg
5.5	G1/4	9401A06 13	6.5	17	31.5	70.5	0.105
	G3/8	9401A06 17	9	21	31.5	73.5	0.123
	G1/2	9401A06 21	9	25	31.5	70.5	0.150

C 9000 Series: single shut-off = 1250 NI/min

## 9405A Coupler, Male BSPT Thread

Technical polymer, nickel-plated brass, NBR

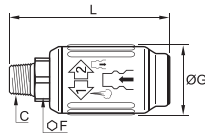

DN	C		F	G	L	Kg
5.5	R1/4	9405A06 13	17	31.5	73	0.105
	R3/8	9405A06 17	19	31.5	74.5	0.110
	R1/2	9405A06 21	22	31.5	79.5	0.140

C 9000 Series: single shut-off = 1250 NI/min

## 9414A Coupler, Female BSPP Thread

Technical polymer, nickel-plated brass, NBR

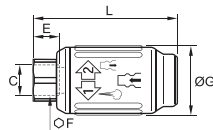

DN	C		E	F	G	L	Kg
5.5	G1/4	9414A06 13	12	17	31.5	64.5	0.095
	G3/8	9414A06 17	12	22	31.5	70	0.115
	G1/2	9414A06 21	15	27	31.5	76	0.145

C 9000 Series: single shut-off = 1250 NI/min

## 9410A Coupler, LF 3000® Push-In Connection, with Spiral Protection Spring

Technical polymer, nickel-plated brass, NBR

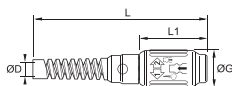

DN	ØD		G	L	L1	Kg
5.5	8	9410A06 08	31.5	143	54	0.140
	10	9410A06 10	31.5	143	54	0.175

C 9000 Series: single shut-off = 1250 NI/min

## 9421A Coupler with Hosetail

Technical polymer, nickel-plated brass, NBR

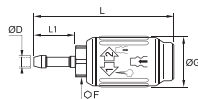

DN	ØD		F	G	L	L1	Kg
5.5	6	9421A06 06	17	31.5	86.5	26	0.110
	8	9421A06 08	17	31.5	86.5	26	0.100
	10	9421A06 10	17	31.5	86.5	26	0.100

C 9000 Series: single shut-off = 1250 NI/min

# ARO Profile

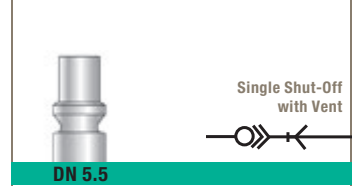

## 9416A Coupler, Bulkhead Mountable, Female BSPP Thread

Technical polymer, nickel-plated brass, NBR

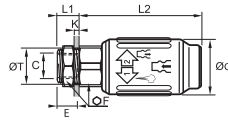

DN	C		E	F	G	K	L1	L2	ØT	Kg
5.5	G1/4	<a href="#">9416A06 13</a>	12	22	31.5	6	12.5	66.5	18.5	0.135

C 9000 Series: single shut-off = 1250 NI/min

## 9440A Y Coupler, Female BSPP Thread

Technical polymer, nickel-plated brass, NBR

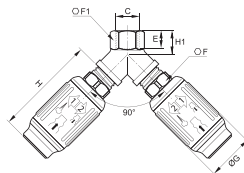

DN	C		E	F	F1	G	H	H1	Kg
5.5	G3/8	<a href="#">9440A06 17</a>	11.5	19	20	31.5	68	16	0.263

C 9000 Series: single shut-off = 1250 NI/min

## 9087A Probe, Straight-Through, Male BSPP Thread

Nickel-plated steel, technical polymer

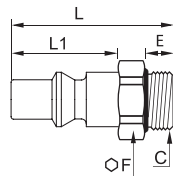

DN	C		E	F	L	L1	Kg
5.5	G1/4	<a href="#">9087A06 13</a>	9	17	36	22	0.020
	G3/8	<a href="#">9087A06 17</a>	9	19	36	22	0.024
	G1/2	<a href="#">9087A06 21</a>	12	24	40	22	0.050

Probe without shut-off

## 9086A Probe, Straight-Through, Female BSPP Thread

Nickel-plated steel

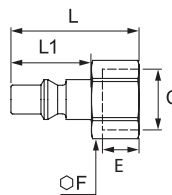

DN	C		E	F	L	L1	Kg
5.5	G1/4	<a href="#">9086 22 13</a>	9	17	35.5	22	0.024
	G3/8	<a href="#">9086 22 17</a>	10	19	35.5	22	0.023
	G1/2	<a href="#">9086 22 21</a>	12	24	38	22	0.039

Probe without shut-off

## 9084A Probe, Straight-Through, Male BSPT Thread

Nickel-plated steel

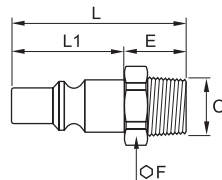

DN	C		F	L	L1	Kg
5.5	R1/4	<a href="#">9084 22 13</a>	14	40.5	22	0.020
	R3/8	<a href="#">9084 22 17</a>	17	40.5	22	0.031
	R1/2	<a href="#">9084 22 21</a>	22	46	22	0.048

Probe without shut-off



# ARO Profile

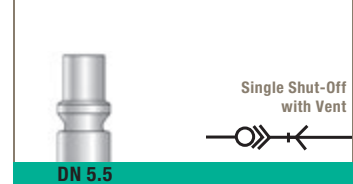

## 9080A Probe, Straight-Through, LF 3000® Push-In Connection, with Spiral Protection Spring

Nickel-plated steel, NBR

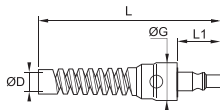

DN	ØD		G	L	L1	Kg
5.5	8	9080A06 08	24	118	22	0.028
	10	9080A06 10	24	118	22	0.027

Probe without shut-off

## 9094A Probe, Straight-Through, with Hosetail

Nickel-plated steel

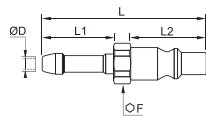

DN	ØD		F	L	L1	L2	Kg
5.5	6	9094A06 06	14	48.5	22	25	0.013
	8	9094A06 08	14	48.5	22	25	0.014
	10	9094A06 10	14	48.5	22	25	0.017

Probe without shut-off



# Metal Quick-Acting Coupler Range

## Nickel-Plated Brass Quick-Acting Couplers

### Mini Series



### Standard Series



### Midi Series



### Maxi Series



## Metal Quick-Acting Coupler Accessories



# Metal Quick-Acting Couplers

In order to fulfill the requirements of the **widest range of industrial applications**, Parker Legris offers a range of metal couplers compatible with a large selection of fluids.

**Simple to install**, with or without shut-off valves, these couplers offer a **high flow rate capability**.

## Product Advantages

**Easy-to-Use** | Coupler with sliding sleeve: automatic connection and disconnection  
 Extremely compact  
 Single or double shut-off models for greater safety  
 Special range designed for pneumatic applications: mini and standard series  
 Special range designed for the transmission of water and fluids: midi and maxi series

**Robust & Reliable** | 100% leak-tested in production  
 Excellent shock and impact resistance  
 Nickel-plated brass for corrosion resistance

**Optimum Performance** | Very wide range of flow rates  
 Low pressure drop  
 Long service life  
 Maximum energy efficiency



**Applications**

- Workshops
- Flushing
- Spraying
- Packaging
- Factory Automation
- Filling Systems
- Cleaning

## Technical Characteristics

<b>Compatible Fluids</b>	Compressed air, water
<b>Working Pressure</b>	0 to 20 bar
<b>Working Temperature</b>	-20°C to +100°C

Guaranteed for use with a vacuum of 655 mm Hg (86% vacuum).

### Component Materials

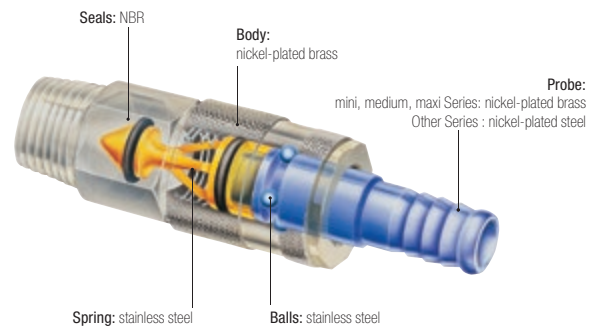

Silicone-free

# Metal Quick-Acting Couplers

## Metal Quick-Acting Coupler Technology and Flow Rates

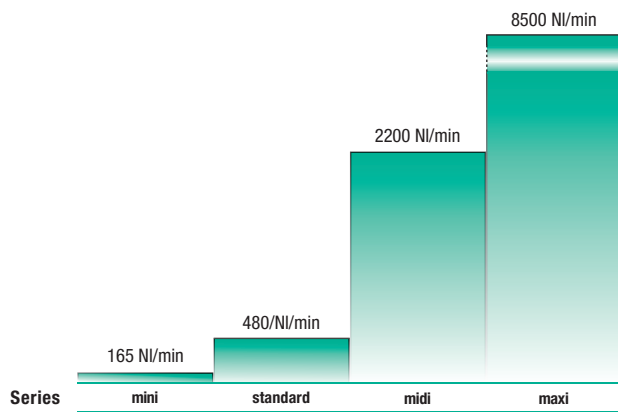

Measurements carried out in accordance with ISO 6358 at a pressure of 6 bar, pressure drop < 0.7 bar (single shut-off flow)

## 3 Shut-Off Functions

### Straight-Through

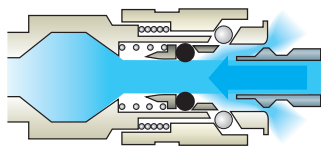

### Single Shut-Off

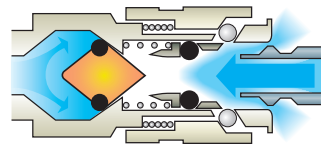

Single shut-off coupler  
+ probe without shut-off  
When disconnected, the fluid path is closed upstream (body side).

### Double Shut-Off

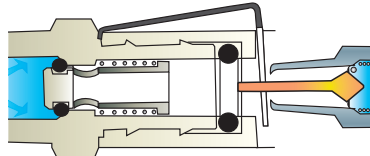
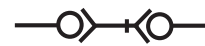

Double shut-off coupler  
+ probe with shut-off  
When disconnected, the fluid path is closed upstream (body side) and downstream (probe side).

## Operation



# Mini Series

Single Shut-Off



Double Shut-Off



## 0171 Coupler, Male BSPT and Parallel Metric Thread

Technical polymer, nickel-plated brass, NBR

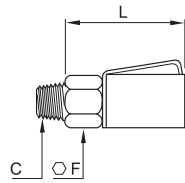

DN	C		E	F	L	Kg
M7x1			6	10	21	0.007
		<a href="#">0171 02 55 01</a>				
2	R1/8	<a href="#">0171 02 10 01</a>	7.5	10	21	0.010
		<a href="#">0171 02 10 02</a>	7.5	10	21	0.010
		<a href="#">0171 02 10 03</a>	7.5	10	21	0.010
		<a href="#">0171 02 10 04</a>	7.5	10	21	0.010
		<a href="#">0171 02 10 05</a>	7.5	10	21	0.010

Single shut-off

Mini Series (DN 2): single shut-off= 165 NI/min

## 0183 Probe, Valved, Male BSPT Thread

Nickel-plated brass, NBR

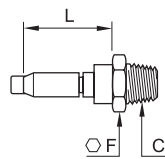

DN	C		F	L	Kg
2	R1/8	<a href="#">0183 02 10</a>	10	13	0.007

Probe with shut-off

## 0184 Probe, Straight-Through, Male BSPT Thread

Nickel-plated brass

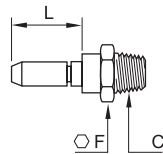

DN	C		F	L	Kg
2	R1/8	<a href="#">0184 02 10</a>	10	13	0.006

Probe without shut-off

## 0181 Probe without shut-off, Male BSPT Thread

Nickel-plated brass

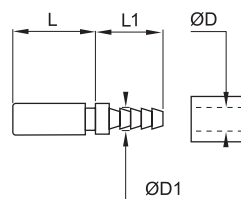

DN	ØD	ØD1		L	L1	Kg
2	3	3.3	<a href="#">0181 03 04</a>	11.5	13.5	0.010

Probe without shut-off

# Mini Series

Single Shut-Off

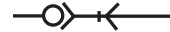

Double Shut-Off

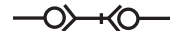

## 0171 Coupler, Straight-Through, Male BSPT Thread

Technical polymer, nickel-plated brass, NBR

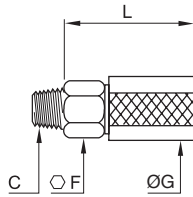

DN	C		F	G	L	Kg
3	R1/8		13	17	24.5	0.020
		0171 03 10 01	13	17	24.5	0.020
		0171 03 10 02	13	17	24.5	0.020
		0171 03 10 03	13	17	24.5	0.020
		0171 03 10 04	13	17	24.5	0.020
		0171 03 10 05	13	17	24.5	0.020

Straight-through

## 0181 Probe, Straight-Through with Barb Connection for Polyamide (PA) Tubing

Nickel-plated brass

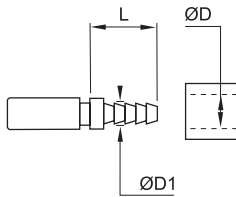

DN	ØD	ØD1		L	Kg
3	4	4.7		19	0.005

Probe without shut-off

## 0180 Probe, Straight-Through with Barb Connection for Flexible Tubing

Nickel-plated brass

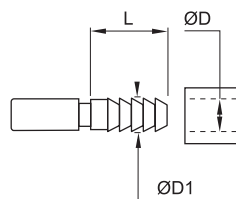

DN	ØD	ØD1		L	Kg
3	4	6		19	0.007
	5	6.5	0180 05 00	19	0.007

Probe without shut-off

## 3150 Probe, Straight-Through with LF 3000® Push-In Connection

Nickel-plated brass, NBR

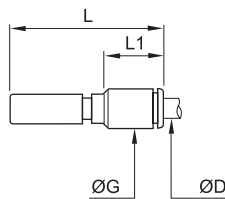

DN	ØD		G	L	L1	Kg
3	4		8.5	39	18	0.008

Probe without shut-off

# Standard Series

Single Shut-Off

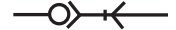

## 0172 Coupler, Female BSPP Thread

Nickel-plated brass, NBR

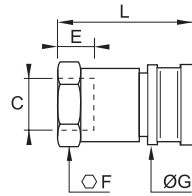

DN	C		E	F	G	L	Kg
5	G1/4	<a href="#">0172 05 13</a>	11	19	21	47	0.086

Standard Series: single shut-off = 480 NI/min

## 0187 Probe, Straight-Through, Male BSPP Thread

Zinc-plated blister steel

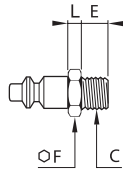

DN	C		E	F	L	Kg
5	G1/8	<a href="#">0187 05 10</a>	7	14	4	0.018
	G1/4	<a href="#">0187 05 13</a>	9.5	17	5	0.027

Probe without shut-off

## 0186 Probe, Straight-Through, Female BSPP Thread

Zinc-plated blister steel

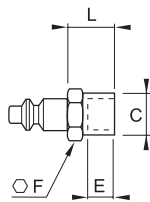

DN	C		E	F	L	Kg
5	G1/4	<a href="#">0186 05 13</a>	12	17	17	0.027

Probe without shut-off

## 0185 Probe, Straight-Through, with Barb Connection for Flexible Tubing

Zinc-plated blister steel

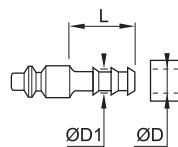

DN	ØD	ØD1		L	Kg
5	4	6	<a href="#">0185 04 00</a>	22.5	0.014
	7	9	<a href="#">0185 07 00</a>	22.5	0.017
	10	12.2	<a href="#">0185 10 00</a>	22.5	0.013

Probe without shut-off

## 0189 Double Probe

Zinc-plated blister steel

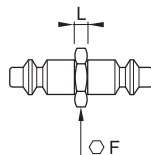

DN		F	L	Kg
5	<a href="#">0189 05 00</a>	12	4	0.025

Probe without shut-off



# Midi Series

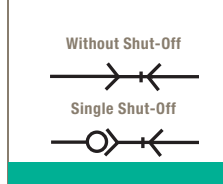

## 0172 Coupler, Female BSPP Thread

Nickel-plated brass, NBR

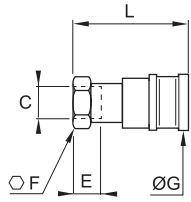

DN	C		E	F	G	L	Kg
12	G3/8	<a href="#">0172 12 17</a>	16	27	29	56	0.155
	G1/2	<a href="#">0172 12 21</a>	16	27	29	56	0.142

Midi Series: single shut-off = 2200 NI/min

## 2272 Coupler, Straight-Through, Female BSPP Thread

Nickel-plated brass, NBR

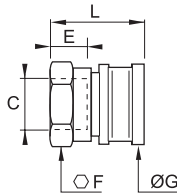

DN	C		E	F	G	L	Kg
12	G1/2	<a href="#">2272 12 21</a>	10	24	29	33	0.066
	G3/4	<a href="#">2272 12 27</a>	10	30	29	34.5	0.074
	G1	<a href="#">2272 12 34</a>	10	36	29	34.5	0.081

## 2511 Coupler with Barb Connection for Hose

Nickel-plated brass, NBR

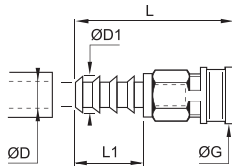

DN	ØD	ØD1		G	L	L1	Kg
12	12	13.5	<a href="#">2511 12 12</a>	29	75	32	0.145
	15	16.5	<a href="#">2511 12 15</a>	29	75	32	0.147
	19	20.5	<a href="#">2511 12 19</a>	29	81	38	0.160

Midi Series: single shut-off = 2200 NI/min

## 2297 Coupler, Straight-Through, with Barb Connection for Hose

Nickel-plated brass, NBR

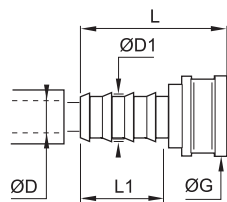

DN	ØD	ØD1		G	L	L1	Kg
12	12	13.5	<a href="#">2297 12 12</a>	29	51	27	0.072
	15	16.5	<a href="#">2297 12 15</a>	29	51	27	0.075
	19	20.5	<a href="#">2297 12 19</a>	29	57	33	0.092

## 2294 Probe, Straight-Through, Male BSPP Thread

Nickel-plated brass

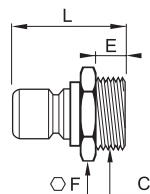

DN	C		E	F	L	Kg
12	G3/8	<a href="#">2294 12 17</a>	6	22	31.5	0.031
	G1/2	<a href="#">2294 12 21</a>	9.5	22	37	0.044
	G3/4	<a href="#">2294 12 27</a>	13.5	27	41	0.068
	G1	<a href="#">2294 12 34</a>	10.5	34	36	0.071

Probe without shut-off

# Midi Series

Without Shut-Off



Single Shut-Off

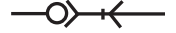

## 0196 Probe, Straight-Through, Female BSPP Thread

Nickel-plated brass

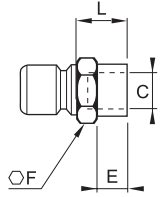

DN	C		E	F	L	Kg
12	G1/4	<a href="#">0196 12 13</a>	12	17	16	0.027
	G3/8	<a href="#">0196 12 17</a>	12	21	15	0.034
	G1/2	<a href="#">0196 12 21</a>	14	26	17	0.051

Probe without shut-off

## 2296 Probe, Straight-Through, Female BSPP Thread

Nickel-plated brass

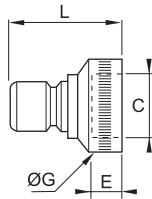

DN	C		E	G	L	Kg
12	G1/2	<a href="#">2296 12 21</a>	11	24	31.5	0.031
	G3/4	<a href="#">2296 12 27</a>	11	30	38	0.058
	G1	<a href="#">2296 12 34</a>	11	36	36.5	0.059

Probe without shut-off

## 0195 Probe, Straight-Through, with Barb Connection for Flexible Tubing

Nickel-plated brass

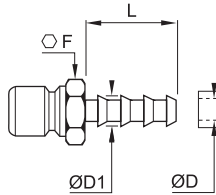

DN	ØD	ØD1		F	L	Kg
12	7	9	<a href="#">0195 07 00</a>	17	29.5	0.027
	10	12.2	<a href="#">0195 10 00</a>	17	29.5	0.028
	13	15.2	<a href="#">0195 13 00</a>	17	29.5	0.030
	16	18.5	<a href="#">0195 16 00</a>	21	36.5	0.048

Probe without shut-off

## 2295 Probe, Straight-Through, with Barb Connection for Flexible Hose

Nickel-plated brass

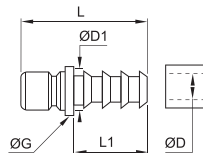

DN	ØD	ØD1		G	L	L1	Kg
12	12	13.5	<a href="#">2295 12 12</a>	17	48	27	0.025
	15	16.5	<a href="#">2295 12 15</a>	18	48	27	0.033
	19	20.5	<a href="#">2295 12 19</a>	24	57	33	0.053

Probe without shut-off

## 2293 Y Coupler, Straight-Through

Nickel-plated brass, NBR

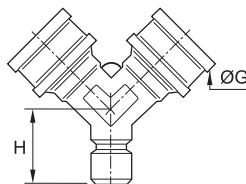

DN		G	H	Kg
12	<a href="#">2293 12 00</a>	29	27	0.132

Probe without shut-off

Midi Series: straight-through = 2200 NI/min

# Midi Series

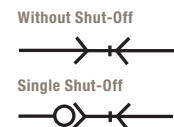

## 2270 Coupler with Tap, Male BSP Thread

Nickel-plated brass, NBR

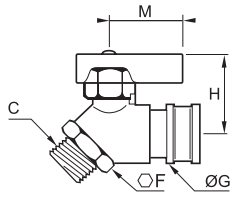

DN	C		F	G	H	M	Kg
12	G1/2	<b>2270 21 00</b>	28	29	40.5	35	0.278

Flow = 2200 NI/min

## 2203 Plug

Nickel-plated brass

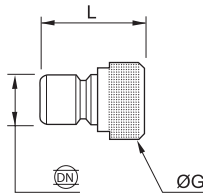

DN		G	L	Kg
12	<b>2203 12 00</b>	20	34	0.042

## 2292 Universal Coupler Adaptor

Nickel-plated brass, NBR

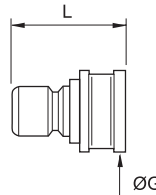

DN		G	L	Kg
12	<b>2292 12 00</b>	29	40.5	0.083

Without shut-off

This adaptor provides interchangeability with numerous components (especially watering accessories).

## 2398 Universal Probe Adaptor

Nickel-plated brass, NBR

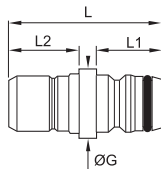

DN		G	L	L1	L2	Kg
12	<b>2398 12 01</b>	20	43	19	18.5	0.035

This adaptor provides interchangeability with numerous components (especially watering accessories).

# Midi Series

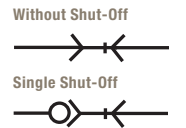

## 2299 Water Pistol

Zamak, nickel-plated brass, NBR

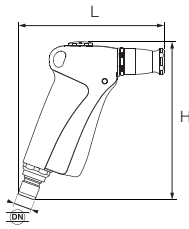

12 **2299 12 01**

**H L Kg**

140 126 0.468

This pistol allows independent control of:

- the flow rate (trigger)
- type of jet (adjustable to a fine mist) by the adjustable probe

## 2299 Adjustable Nozzle

Nickel-plated brass, NBR

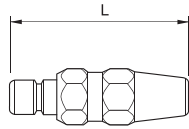

12 **2299 12 20**

**L Kg**

77.4 0.137

This nozzle allows adjustment of the spray.

# Maxi Series

Without Shut-Off



## 2272 Coupler, Straight-Through, Female BSPP Thread

Nickel-plated brass, NBR

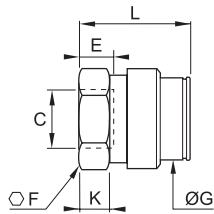

DN	C		E	F	G	K	L	Kg
19	G1	<a href="#">2272 18 34</a>	9	36	42	11	45	0.181

Maxi Series: straight-through = 8500 NI/min

## 2297 Coupler, Straight-Through with Barb Connection for Hose

Nickel-plated brass, NBR

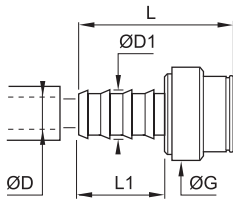

DN	ØD	ØD1		G	L	L1	Kg
19	19	20.7	<a href="#">2297 18 20</a>	39.5	69	37	0.163

Maxi Series: straight-through = 8500 NI/min

## 2294 Coupler, Straight-Through, Male BSPP Thread

Nickel-plated brass

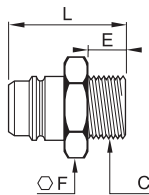

DN	C		E	F	L	Kg
19	G3/4	<a href="#">2294 18 27</a>	10.5	27	42.5	0.070
	G1	<a href="#">2294 18 34</a>	13	34	46	0.102

Probe without shut-off

## 2295 Coupler, Straight-Through with Barb Connection for Flexible Hose

Nickel-plated brass

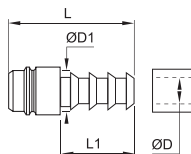

DN	ØD	ØD1		L	L1	Kg
19	19	21	<a href="#">2295 18 20</a>	69	41	0.068

Probe without shut-off

# Quick-Acting Coupler Accessories

Parker Legris has developed a range of accessories for quick-acting couplers which save time, **match the product** to the application and **increase the life** of the equipment.

## Product Advantages

**Performance**

- Interchangeability with ISO B probe profile
- Avoids tube twisting
- Facilitates use by following movements
- Robust

**Adaptable**

Two models depending on the application:

Oscillating fittings:

- angled at 45° and fitted with a ball bearing
- effortless rotation through 360°

Flexible fittings:

- fitted with a ball joint mounted on a lubricated plastic seat
- single connection providing an angle of rotation of 70°
- multiple tees (three connections) providing an angle of rotation of 360°

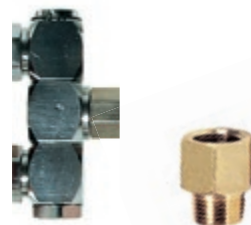

Pneumatics  
Water  
Workshops  
Industrial Machinery

Applications

## Technical Characteristics

<b>Compatible Fluids</b>	Industrial fluids
<b>Working Pressure</b>	Oscillating fittings: 0 to 15 bar Flexible fittings: 0 to 10 bar Swivelling multiple tees: 0 to 20 bar
<b>Working Temperature</b>	-5°C to +60°C

### Component Materials



Other accessories are available on request:

- ISO B rotary fitting, male BSPT
- ISO B jointed fitting, male BSPP
- multiple tee with 2 outlets, female male BSPP



# Quick-Acting Coupler Accessories

## 9071U Oscillating ISO B Probe, Male BSPP Thread

Treated steel, NBR

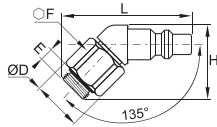

DN	C		E	F	H	L	Kg
6	G1/4	<a href="#">9071U06 13</a>	5.5	19	30	52	0.066
8	G1/4	<a href="#">9071U08 13</a>	5.5	19	30	52	0.064

200 parts per box (minimum of order)

## 0691 Flexible Fitting, Female/Male BSPP Thread

Treated steel, NBR

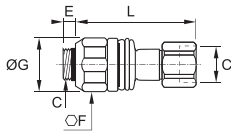

DN	C		E	F	G	L	Kg
5.5	G1/4	<a href="#">0691 13 13</a>	5.5	24	25.5	56	0.090

NBR Sleeve

## 0681 Multiple Tee with 3 Female Outlets, Male/Female BSPP Thread

Chromium-plated brass, NBR

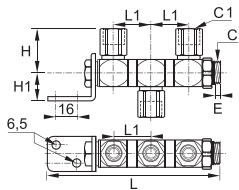

C	C1		E	H	H1	L	L1	Kg
G1/2	G1/4	<a href="#">0681 13 21</a>	7.5	36	24	138.5	30	0.430

## 0164 Adaptor, Male NPT/Female BSPP Thread

Brass

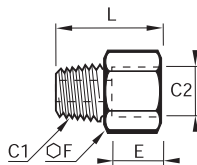

C1	C2		E	F	L	Kg
NPT1/8	G1/8	<a href="#">0164 11 10</a>	7.5	14	20	0.015
NPT1/4	G1/4	<a href="#">0164 14 13</a>	11	17	27.5	0.028
NPT3/8	G3/8	<a href="#">0164 18 17</a>	11.5	22	28.5	0.044
NPT1/2	G1/2	<a href="#">0164 22 21</a>	15	27	36.5	0.082
NPT3/4	G3/4	<a href="#">0164 28 27</a>	16.5	32	38.5	0.110

Adaptor for female socket of quick-acting mould couplers

## 0167 Adaptor, Male BSPT/Female NPT Thread

Brass

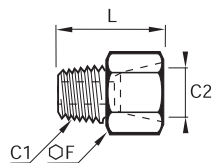

C1	C2		F	L	Kg
R1/8	NPT1/8	<a href="#">0167 10 11</a>	14	21	0.016
R1/4	NPT1/4	<a href="#">0167 13 14</a>	17	28.5	0.029
R3/8	NPT3/8	<a href="#">0167 17 18</a>	22	29.5	0.047
R1/2	NPT1/2	<a href="#">0167 21 22</a>	27	37.5	0.088
R3/4	NPT3/4	<a href="#">0167 27 28</a>	32	39.5	0.120

Adaptor for female socket of quick-acting mould couplers







# Adaptors and Manifolds





# A Complete Range of Adaptors

## Brass Adaptors

<b>0143</b> BSPP Page 9-7	<b>0144</b> BSPT/BSPP Page 9-7	<b>0152</b> BSPT Page 9-7	<b>0145</b> BSPP Page 9-7	<b>MR0434</b> BSPP/BSPT Page 9-7	<b>0158</b> BSPT/BSPP Page 9-8	<b>0117</b> BSPP Page 9-8	<b>207ACBH</b> NPTF Page 9-8	<b>0155</b> BSPP Page 9-8	<b>GG-B</b> NPTF Page 9-9	<b>207P</b> NPTF Page 9-9	<b>0164</b> NPT/BSPP Page 9-9
---------------------------------	--------------------------------------	---------------------------------	---------------------------------	--	--------------------------------------	---------------------------------	------------------------------------	---------------------------------	---------------------------------	---------------------------------	-------------------------------------



<b>0167</b> BSPT/NPT Page 9-9	<b>0168</b> BSPP Page 9-9	<b>0163</b> BSPT/BSPP Page 9-10	<b>209P</b> NPTF Page 9-10	<b>0169</b> BSPP Page 9-10	<b>FG43</b> BSPP/BSPT Page 9-10	<b>222P</b> NPTF Page 9-11	<b>0121</b> BSPT Page 9-11	<b>FF44</b> BSPP Page 9-11	<b>0121</b> NPT/BSPT Page 9-11	<b>216P</b> NPTF Page 9-12	<b>0929</b> BSPT Page 9-12
-------------------------------------	---------------------------------	---------------------------------------	----------------------------------	----------------------------------	---------------------------------------	----------------------------------	----------------------------------	----------------------------------	--------------------------------------	----------------------------------	----------------------------------



<b>0123</b> BSPT Page 9-12	<b>0136</b> BSPT Page 9-13
----------------------------------	----------------------------------



## Nickel-Plated Brass Adaptors

<b>0912</b> BSPP/Metric Page 9-14	<b>DD44BKTL</b> BSPP Page 9-14	<b>0921</b> Metric Page 9-14	<b>0913</b> BSPT/BSPP Page 9-14	<b>0922</b> Metric Page 9-14	<b>0914</b> BSPT Page 9-15	<b>0910</b> BSPP Page 9-15	<b>0911</b> BSPT/BSPP Page 9-15	<b>0915</b> BSPP/Metric Page 9-15	<b>0923</b> Metric Page 9-15	<b>0916</b> BSPT/BSPP Page 9-16	<b>0924</b> Metric Page 9-16
---	--------------------------------------	------------------------------------	---------------------------------------	------------------------------------	----------------------------------	----------------------------------	---------------------------------------	---	------------------------------------	---------------------------------------	------------------------------------



<b>0917</b> BSPT/BSPP Page 9-16	<b>0927</b> BSPT Page 9-16	<b>0928</b> BSPT/BSPP Page 9-16	<b>0932</b> BSPT/BSPP Page 9-17	<b>0908</b> BSPP Page 9-17	<b>0909</b> BSPT/BSPP Page 9-17	<b>KRRS3</b> BSPT Page 9-17	<b>0903</b> BSPP/BSPT Page 9-17	<b>0904</b> BSPT/BSPP Page 9-18	<b>0905</b> BSPP/Metric Page 9-18	<b>0906</b> BSPP/Metric Page 9-18	<b>0933</b> BSPT/BSPP Page 9-18
---------------------------------------	----------------------------------	---------------------------------------	---------------------------------------	----------------------------------	---------------------------------------	-----------------------------------	---------------------------------------	---------------------------------------	---	---	---------------------------------------



<b>0907</b> BSPP Page 9-19	<b>0920</b> BSPP/Metric Page 9-19	<b>0900</b> BSPT Page 9-19	<b>0901</b> BSPP/Metric Page 9-19	<b>0192</b> BSPT/BSPP Page 9-20	<b>0902</b> BSPP/Metric Page 9-20	<b>0191</b> BSPP Page 9-20	<b>0931</b> BSPP Page 9-20	<b>0934</b> BSPT Page 9-21	<b>0935</b> BSPP Page 9-21
----------------------------------	---	----------------------------------	---	---------------------------------------	---	----------------------------------	----------------------------------	----------------------------------	----------------------------------



## Stainless Steel Adaptors

<b>1844</b> BSPT/BSPP Page 9-22	<b>1843</b> BSPP Page 9-22	<b>1845</b> BSPP Page 9-22	<b>1817</b> BSPP Page 9-22	<b>1871</b> NPT Page 9-22	<b>1855</b> BSPP Page 9-23	<b>1870</b> NPT Page 9-23	<b>1862</b> BSPP Page 9-23	<b>1864</b> NPT/BSPP Page 9-23	<b>1867</b> BSPT/NPT Page 9-23	<b>1863</b> BSPT/BSPP Page 9-24	<b>1872</b> NPT Page 9-24
---------------------------------------	----------------------------------	----------------------------------	----------------------------------	---------------------------------	----------------------------------	---------------------------------	----------------------------------	--------------------------------------	--------------------------------------	---------------------------------------	---------------------------------



<b>1861</b> BSPT/BSPP Page 9-24	<b>1873</b> NPT Page 9-24	<b>1821</b> BSPT Page 9-24	<b>1821</b> NPT Page 9-25	<b>1823</b> BSPT Page 9-25	<b>1823</b> NPT Page 9-25
---------------------------------------	---------------------------------	----------------------------------	---------------------------------	----------------------------------	---------------------------------



# A Complete Range of Manifolds, Plugs and Accessories

## Brass and Aluminium Manifolds

<b>0135</b> BSPP brass Page 9-26	<b>3310</b> Push-In Page 9-27	<b>3311</b> BSPP/Metric Page 9-27	<b>3312</b> BSPP/Metric Page 9-27	<b>3313</b> BSPP Page 9-27	<b>3301</b> Modular Page 9-28	<b>3302</b> Simple, double and triple Page 9-28	<b>3303</b> Plug Page 9-29	<b>3303</b> Elbow Page 9-29
								

## Brass Plugs

<b>0205</b> BSPT Page 9-30	<b>0205</b> NPT Page 9-30	<b>HHP</b> NPTF Page 9-30	<b>219P</b> NPTF Page 9-30	<b>0209</b> BSPT Page 9-30	<b>0220</b> BSPP/Metric Page 9-31	<b>0200</b> BSPP/Metric Page 9-31	<b>0201</b> BSPP/Metric Page 9-32	<b>HP3</b> BSPT Page 9-32	<b>218P</b> NPTF Page 9-32	<b>0202</b> Metric Page 9-32	<b>0936</b> BSPT Page 9-33
											

## Nickel-Plated Brass Hollow Hex Plug

<b>0919</b> BSPP/Metric Page 9-33	<b>0938</b> BSPP Page 9-33	<b>FN4</b> BSPP Page 9-33
		

## Steel Plugs

<b>0206</b> BSPT Page 9-34	<b>0206</b> NPT Page 9-34	<b>0210</b> BSPP/Metric Page 9-34	<b>0216</b> BSPT Page 9-34	<b>0216</b> NPT Page 9-35
				

## Stainless Steel Plugs

<b>0285</b> BSPT Page 9-36	<b>0285</b> NPT Page 9-36
	

## Sealing Accessories

<b>0138</b> Page 9-37	<b>0137</b> Page 9-37	<b>0605</b> Page 9-38	<b>0602</b> Page 9-38	<b>0139</b> Page 9-38
				

## Tube Supports

<b>0127</b> Brass Page 9-39	<b>1827</b> Stainless steel Page 9-39
	

# Adaptors, Plugs and Manifolds

Parker Legris offers a **wide range of adaptors and manifolds** compatible with the various Parker Legris fitting systems. This range of products provides the user with a **complete solution** covering numerous applications, both in non-corrosive and corrosive environments.

## Product Advantages

### Large Range & Flexibility

A complete offer, from the simple adaptor to a modular manifold solution

Large selection of materials for excellent chemical compatibility: brass, steel, stainless steel, aluminium

Surface treatment for increased corrosion resistance: nickel-plated brass or anodised aluminium

Stainless steel for corrosive environments

BSP, BSPT, NPT, NPTF and metric threads

### Performance

Robust design

Suitable for low to high pressure, depending on configuration and material

Forged shapes for mechanical strength



**Applications**

- Packaging
- Robotics
- Textile
- Pneumatics
- Automotive Process
- Food Process

## Technical Characteristics

Products	Adaptors and Plugs				Manifolds
Component Materials	Brass	Nickel-plated brass	Stainless steel 316L	Steel	Anodised aluminium
Working Pressure	1/8" to 1/2": 200 bar 3/4" and 1": 150 bar 1 1/4" to 2": 100 bar, without sealing washer	60 bar	1/8" to 1/2": 200 bar 3/4" and 1": 150 bar 1 1/4" to 2": 100 bar, without sealing washer	1/8" to 1/2": 200 bar 3/4" and 1": 150 bar 1 1/4" to 2": 100 bar, without sealing washer	20 bar
Working Temperature	-60°C to +150°C without sealing washer  -20°C to +100°C with sealing washer	-10°C to +80°C	-20°C to +180°C	-10°C to +80°C	-10°C to +80°C

Thread sealing must be guaranteed by user.

# Brass Adaptors

## 0143 Equal Threaded Elbow, Female BSPP Thread

Brass

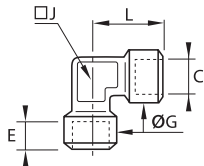

C		E	G	J	L	Kg
G1/8	<a href="#">0143 10 10</a>	7.5	16.5	12	22.5	0.043
G1/4	<a href="#">0143 13 13</a>	11	18.5	15	26.5	0.057
G3/8	<a href="#">0143 17 17</a>	11.5	23.5	19	31.5	0.102
G1/2	<a href="#">0143 21 21</a>	15	28	23	34.5	0.150
G3/4	<a href="#">0143 27 27</a>	16.5	34	27	43.5	0.247

## 0144 Equal Stud Elbow, Male BSPT/Female BSPP Thread

Brass

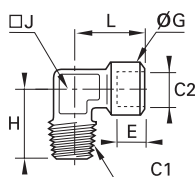

C1	C2		E	G	H	J	L	Kg
R1/8	G1/8	<a href="#">0144 10 10</a>	7.5	16.5	23	12	22.5	0.035
R1/4	G1/4	<a href="#">0144 13 13</a>	11	18.5	26	15	26.5	0.052
R3/8	G3/8	<a href="#">0144 17 17</a>	11.5	23.5	30	19	31.5	0.086
R1/2	G1/2	<a href="#">0144 21 21</a>	15	28	35	23	34.5	0.140
R3/4	G3/4	<a href="#">0144 27 27</a>	16.5	34	40	27	43.5	0.232

## 0152 Equal Elbow, Male BSPT Thread

Brass

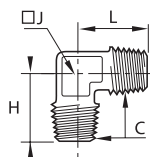

C		H	J	L	Kg
R1/8	<a href="#">0152 10 10</a>	19.5	10	19.5	0.018
R1/4	<a href="#">0152 13 13</a>	25	15	25	0.045
R3/8	<a href="#">0152 17 17</a>	26.5	15	26.5	0.054
R1/2	<a href="#">0152 21 21</a>	31.5	19	31.5	0.088
R3/4	<a href="#">0152 27 27</a>	35.5	23	35.5	0.153

## 0145 Equal Tee, Female BSPP Thread

Brass

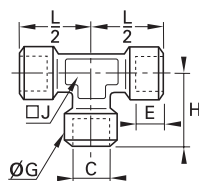

C		E	G	H	J	L/2	Kg
G1/8	<a href="#">0145 10 10</a>	7.5	16.5	22.5	12	22.5	0.057
G1/4	<a href="#">0145 13 13</a>	11	18.5	26.5	15	26.5	0.079
G3/8	<a href="#">0145 17 17</a>	11.5	23.5	31	19	31	0.126
G1/2	<a href="#">0145 21 21</a>	15	28	38	23	38	0.244
G3/4	<a href="#">0145 27 27</a>	16.5	34	47.5	27	47.5	0.370

## MR0434 Stud Run Tee, Female BSPP/Male BSPT Thread

Brass

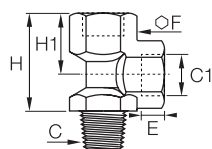

C	C1		E	F	H	H1	H2	Kg
R1/8	G1/8	<a href="#">1/8MR0434B</a>	8	14	32	17	15	0.029
R1/4	G1/4	<a href="#">1/4MR0434B</a>	10	17	40	22	18	0.051
R3/8	G3/8	<a href="#">3/8MR0434B</a>	12	24	49	25	24	0.127
R1/2	G1/2	<a href="#">1/2MR0434B</a>	14	30	63	32	31	0.254



# Brass Adaptors

## 0158

### Stud Branch Tee, Male BSPT/Female BSPP Thread

Brass

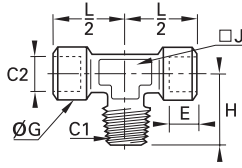

C1	C2		E	G	H	J	L/2	Kg
R1/8	G1/8	<a href="#">0158 10 10</a>	7.5	16.5	21.5	12	21.5	0.046
R1/4	G1/4	<a href="#">0158 13 13</a>	11	18.5	26	15	26	0.075
R3/8	G3/8	<a href="#">0158 17 17</a>	11.5	23.5	30	19	30	0.120
R1/2	G1/2	<a href="#">0158 21 21</a>	15	28	36	23	36	0.204
R3/4	G3/4	<a href="#">0158 27 27</a>	16.5	34	44	27	44	0.310

## 0117

### Equal Bulkhead Coupling, Female BSPP and Metric Thread

Brass

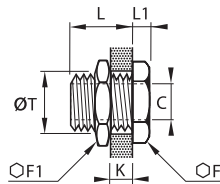

C		F	F1	K <sub>max</sub>	L	L1	ØT	Kg
M5x0.8	<a href="#">0117 00 19</a>	14	14	7	10.5	3.5	10.5	0.012
G1/8	<a href="#">0117 00 10</a>	19	22	9	14	4	16.5	0.033
G1/4	<a href="#">0117 00 13</a>	24	27	15	21	4	20.5	0.056
G3/8	<a href="#">0117 00 17</a>	30	32	14	21	5	26.5	0.096
G1/2	<a href="#">0117 00 21</a>	32	36	20	27	6	28.5	0.115
G3/4	<a href="#">0117 00 27</a>	41	41	22.5	30	6	34.5	0.161
G1	<a href="#">0117 00 34</a>	46	50	24.5	34	8	42.5	0.266
G1 1/4	<a href="#">0117 00 42</a>	55	55	29.5	39	8	49.5	0.303
G1 1/2	<a href="#">0117 00 49</a>	60	60	29.5	39	8	54.5	0.303

## 207ACBH

### Bulkhead Union, Female NPTF Thread

Brass

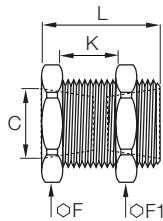

C		F*	F1*	K	L	Kg
NPTF1/8*	<a href="#">207ACBH-2</a>	7/8	15/16	20	38	0.073
NPTF1/4	<a href="#">207ACBH-4</a>	1	1.1/8	18	38	0.101
NPTF3/8	<a href="#">207ACBH-6</a>	1.1/8	1.1/4	13	34	0.127
NPTF1/2	<a href="#">207ACBH-8</a>	1.1/4	1.3/8	16	38	0.158

\*Inch dimensions

## 0155

### Equal Connector, Female BSPP Thread

Brass

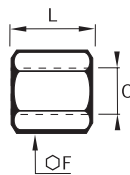

C	C1		F	L	Kg
G1/8	G1/8	<a href="#">0155 10 10</a>	14	17	0.014
G1/4	G1/8	<a href="#">0155 10 13</a>	17	18	0.023
G3/8	G1/8	<a href="#">0155 10 17</a>	22	20	0.045
G1/2	G1/8	<a href="#">0155 10 21</a>	27	22	0.075
G1/4	G1/4	<a href="#">0155 13 13</a>	17	24	0.025
G3/8	G1/4	<a href="#">0155 13 17</a>	22	22	0.046
G1/2	G1/4	<a href="#">0155 13 21</a>	27	24	0.079
G3/8	G3/8	<a href="#">0155 17 17</a>	22	25	0.045
G1/2	G3/8	<a href="#">0155 17 21</a>	17	26	0.048
	G1/2	<a href="#">0155 21 21</a>	27	32	0.084
G3/4	G3/4	<a href="#">0155 27 27</a>	32	35	0.109
G1	G1	<a href="#">0155 34 34</a>	41	36	0.194



# Brass Adaptors

## GG-B Equal Adaptor, Female NPTF Thread, Heavy Series

Brass

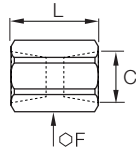

C		F*	L	Kg
NPTF1/8	<a href="#">1/8 GG-B</a>	5/8	19	0.018

\*Inch dimensions  
Max. working pressure: 260 bar

## 207P Equal Adaptor, Female NPTF Thread

Brass

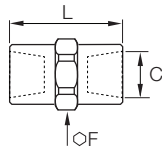

C		F*	L	Kg
NPTF1/8	<a href="#">207P-2</a>	9/16	19	0.017
NPTF1/4	<a href="#">207P-4</a>	3/4	28	0.040
NPTF3/8	<a href="#">207P-6</a>	7/8	28	0.054
NPTF1/2	<a href="#">207P-8</a>	1.1/16	38	0.088

\*Inch dimensions

## 0164 Adaptor, Male NPT/Female BSPP Thread

Brass

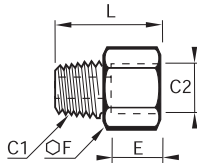

C1	C2		E	F	L	Kg
NPT1/8	G1/8	<a href="#">0164 11 10</a>	7.5	14	20	0.015
NPT1/4	G1/4	<a href="#">0164 14 13</a>	11	17	27.5	0.028
NPT3/8	G3/8	<a href="#">0164 18 17</a>	11.5	22	28.5	0.044
NPT1/2	G1/2	<a href="#">0164 22 21</a>	15	27	36.5	0.082
NPT3/4	G3/4	<a href="#">0164 28 27</a>	16.5	32	38.5	0.110

## 0167 Adaptor, Male BSPT/Female NPT Thread

Brass

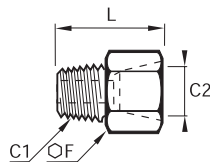

C1	C2		F	L	Kg
R1/8	NPT1/8	<a href="#">0167 10 11</a>	14	21	0.016
R1/4	NPT1/4	<a href="#">0167 13 14</a>	17	28.5	0.029
R3/8	NPT3/8	<a href="#">0167 17 18</a>	22	29.5	0.047
R1/2	NPT1/2	<a href="#">0167 21 22</a>	27	37.5	0.088
R3/4	NPT3/4	<a href="#">0167 27 28</a>	32	39.5	0.120

## 0168 Reducer, Male BSPP/Female BSPP and Metric Thread

Brass, technical polymer

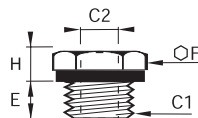

C1	C2		E	F	H	Kg
G1/8	M5x0.8	<a href="#">0168 10 19</a>	7	14	6	0.009
G1/4	M5x0.8	<a href="#">0168 13 19</a>	7	17	7	0.017
	G1/8	<a href="#">0168 13 10</a>	7	17	7	0.011
G3/8	G1/8	<a href="#">0168 17 10</a>	9	19	6	0.019
	G1/4	<a href="#">0168 17 13</a>	9	19	6	0.013
G1/2	G1/8	<a href="#">0168 21 10</a>	11	24	10	0.051
	G1/4	<a href="#">0168 21 13</a>	11	24	10	0.042
	G3/8	<a href="#">0168 21 17</a>	11	24	10	0.030
G3/4	G1/4	<a href="#">0168 27 13</a>	11	32	12	0.098
	G3/8	<a href="#">0168 27 17</a>	11	32	12	0.085
	G1/2	<a href="#">0168 27 21</a>	11	32	12	0.063

With fitted captive seal

# Brass Adaptors

## 0163 Unequal Reducer, Male BSPT/Female BSPP Thread

Brass

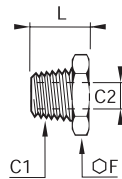

C1	C2		F	L	Kg
R1/4	G1/8	<a href="#">0163 13 10</a>	14	16	0.009
R3/8	G1/8	<a href="#">0163 17 10</a>	17	16.5	0.020
	G1/4	<a href="#">0163 17 13</a>	17	16.5	0.012
R1/2	G1/8	<a href="#">0163 21 10</a>	22	21	0.048
	G3/8	<a href="#">0163 21 17</a>	22	21	0.025
	G1/4	<a href="#">0163 21 13</a>	22	24	0.085
R3/4	G3/8	<a href="#">0163 27 17</a>	27	24	0.069
	G1/2	<a href="#">0163 27 21</a>	27	24	0.046
R1	G1/2	<a href="#">0163 34 21</a>	36	27	0.137
	G3/4	<a href="#">0163 34 27</a>	36	27	0.092

## 209P Reducer, Male/Female NPTF Thread

Brass

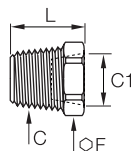

C	C1		F*	L	Kg
NPTF1/4	NPTF1/8	<a href="#">209P-4-2</a>	9/16	19	0.012
NPTF3/8	NPTF1/8	<a href="#">209P-6-2</a>	11/16	18	0.025
	NPTF1/4	<a href="#">209P-6-4</a>	11/16	19	0.179
NPTF1/2	NPTF1/8	<a href="#">209P-8-2</a>	7/8	25	0.049
	NPTF1/4	<a href="#">209P-8-4</a>	7/8	26	0.049
NPTF3/4	NPTF3/8	<a href="#">209P-8-6</a>	7/8	26	0.033
	NPTF1/4	<a href="#">209P-12-4</a>	1.1/8	25	0.080
	NPTF3/8	<a href="#">209P-12-6</a>	1.1/8	26	0.080
	NPTF1/2	<a href="#">209P-12-8</a>	1.1/8	26	0.057

\*Inch dimensions

## 0169 Increaser, Male/Female BSPP Thread

Brass, technical polymer

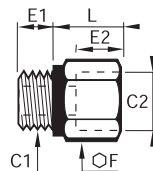

C1	C2		E1	E2	F	L	Kg
G1/8	G1/4	<a href="#">0169 10 13</a>	5	11	17	16	0.019
	G3/8	<a href="#">0169 10 17</a>	5	14	22	19.5	0.038
G1/4	G3/8	<a href="#">0169 13 17</a>	7	14	22	19.5	0.042
	G1/2	<a href="#">0169 13 21</a>	7	14.5	27	20.5	0.061
G3/8	G1/2	<a href="#">0169 17 21</a>	8	14.5	27	20.5	0.062
	G3/4	<a href="#">0169 17 27</a>	8	15.5	32	22	0.082
G1/2	G3/4	<a href="#">0169 21 27</a>	9.5	15.5	32	22.5	0.087

With fitted captive seal

## FG43 Reducer, Female BSPP/Male BSPT Thread

Brass

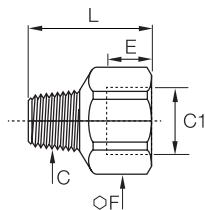

C	C1		E	F	L	Kg
R1/8	G1/4	<a href="#">1/4X1/8FG43B</a>	11	17	21.5	0.020
	G3/8	<a href="#">3/8X1/8FG43B</a>	12	22	25	0.035
R1/4	G1/2	<a href="#">1/2X1/8FG43B</a>	15	27	28	0.063
	G3/8	<a href="#">3/8X1/4FG43B</a>	12	22	28	0.040
R3/8	G1/2	<a href="#">1/2X1/4FG43B</a>	15	27	30	0.071
	G1/2	<a href="#">1/2X3/8FG43B</a>	15	27	29	0.066
R1/2	G3/4	<a href="#">3/4X1/2FG43B</a>	16	32	39	0.113
R3/4	G1	<a href="#">1X3/4FG43B</a>	18	41	38	0.168

# Brass Adaptors

## 222P

### Reducer, Female/Male NPTF Thread

Brass

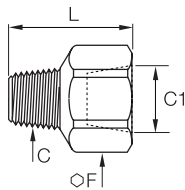

C	C1		F*	L	Kg
NPTF1/8	NPTF1/8	<a href="#">222P-2-2</a>	9/16	22	0.017
	NPTF1/4	<a href="#">222P-4-2</a>	3/4	27	0.021
NPTF1/4	NPTF1/4	<a href="#">222P-4-4</a>	3/4	32	0.039
	NPTF3/8	<a href="#">222P-6-4</a>	7/8	32	0.046
NPTF3/8	NPTF3/8	<a href="#">222P-6-6</a>	7/8	32	0.044
NPTF1/4	NPTF1/2	<a href="#">222P-8-4</a>	1	37	0.076
NPTF3/8	NPTF1/2	<a href="#">222P-8-6</a>	1 1/16	37	0.083

\*Inch dimensions

## 0121

### Equal/Unequal Straight Male Adaptor, Male BSPT Thread

Brass

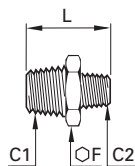

C1	C2		F	L	Kg
R1/8	R1/8	<a href="#">0121 10 10</a>	11	19	0.009
R1/4	R1/8	<a href="#">0121 13 10</a>	14	23.5	0.017
	R1/4	<a href="#">0121 13 13</a>	14	27	0.020
R3/8	R1/8	<a href="#">0121 17 10</a>	17	24	0.022
	R1/4	<a href="#">0121 17 13</a>	17	27.5	0.025
R1/2	R3/8	<a href="#">0121 17 17</a>	17	28	0.026
	R1/8	<a href="#">0121 21 10</a>	22	28.5	0.043
R1/2	R1/4	<a href="#">0121 21 13</a>	22	32	0.045
	R3/8	<a href="#">0121 21 17</a>	22	32.5	0.045
R3/4	R1/2	<a href="#">0121 21 21</a>	22	36	0.053
	R1/4	<a href="#">0121 27 13</a>	27	35	0.077
R3/4	R3/8	<a href="#">0121 27 17</a>	27	35.5	0.077
	R1/2	<a href="#">0121 27 21</a>	27	39	0.083
R1	R3/4	<a href="#">0121 27 27</a>	27	40	0.090
	R3/8	<a href="#">0121 34 17</a>	36	38.5	0.127
R1	R1/2	<a href="#">0121 34 21</a>	36	42	0.136
	R3/4	<a href="#">0121 34 27</a>	36	43	0.143
R1 1/4	R1	<a href="#">0121 34 34</a>	36	46	0.152
	R1/2	<a href="#">0121 42 21</a>	46	46.5	0.217
R1 1/4	R3/4	<a href="#">0121 42 27</a>	46	47.5	0.229
	R1	<a href="#">0121 42 34</a>	46	50.5	0.239
R1 1/4	R1 1/4	<a href="#">0121 42 42</a>	46	53	0.230

## FF44

### Equal Adaptor, Male BSPP Thread

Brass

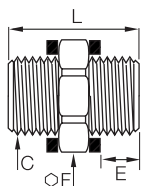

C		E	F	L	Kg
G1/8	<a href="#">1/8FF44B</a>	6	14	19	0.018
G1/4	<a href="#">1/4FF44B</a>	7	17	22	0.022
G3/8	<a href="#">3/8FF44B</a>	8	22	24	0.040
G1/2	<a href="#">1/2FF44B</a>	10	27	31	0.077

These parts are supplied with two copper seals.

## 0121

### Equal Adaptor, Male NPT/BSPT Thread

Brass

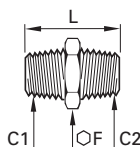



C1	C2		F	L	Kg
NPT1/8	R1/8	<a href="#">0121 11 10</a>	11	19	0.009
NPT1/4	R1/4	<a href="#">0121 14 13</a>	14	27	0.020
NPT3/8	R3/8	<a href="#">0121 18 17</a>	17	28	0.026
NPT1/2	R1/2	<a href="#">0121 22 21</a>	22	36	0.052
NPT3/4	R3/4	<a href="#">0121 28 27</a>	27	40	0.090

# Brass Adaptors

## 216P Equal Adaptor, Male NPTF Thread

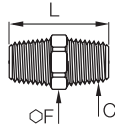
Brass





C	C1		F*	L	Kg
NPTF1/8	NPTF1/8	<a href="#">216P-2</a>	7/16	25	0.008
NPTF3/8	NPTF1/8	<a href="#">216P-6-2</a>	11/16	31	0.028
NPTF1/4	NPTF1/4	<a href="#">216P-4</a>	9/16	35	0.025
	NPTF1/8	<a href="#">216P-4-2</a>	9/16	30	0.001
NPTF3/8	NPTF3/8	<a href="#">216P-6</a>	11/16	36	0.029
	NPTF1/4	<a href="#">216P-6-4</a>	11/16	36	0.033
NPTF1/2	NPTF1/4	<a href="#">216P-8-4</a>	7/8	41	0.057
	NPTF1/2	<a href="#">216P-8</a>	7/8	46	0.064
	NPTF3/8	<a href="#">216P-8-6</a>	7/8	41	0.056

\*Inch dimensions

## 0929 Equal 3-Piece Adaptor, Male BSPT Thread

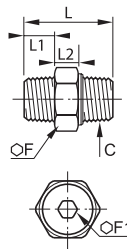
Brass, NBR



C		F	F1	L	L1	L2	Kg
R1/8	<a href="#">0929 01 10</a>	15	5	27	7.5	8.5	0.017
R1/4	<a href="#">0929 01 13</a>	19	6	33.5	11	9.5	0.035
R3/8	<a href="#">0929 01 17</a>	22	8	36.5	11.5	10	0.055
R1/2	<a href="#">0929 01 21</a>	27	12	45	14	12	0.089
R3/4	<a href="#">0929 01 27</a>	36	14	52.5	16.5	17	0.261
R1	<a href="#">0929 01 34</a>	46	19	63.5	19	20	0.600

This connection accessory makes assembly much easier thanks to its 3-piece design.

To join 2 threaded components, simply push together and tighten the sleeve nut, thus reducing installation time.

Maximum working pressure: 50 bar

Working temperature: -10° to +80°C

Supplied with seal

## 0123 Tailpiece Adaptor for Rubber Hose, Male BSPT Thread

Brass

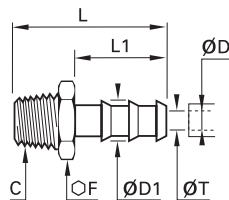

ØD	ØD1	C		F	L	L1	ØT	Kg
4	6	R1/8	<a href="#">0123 04 10</a>	10	34	22.5	3.3	0.008
6	8	R1/8	<a href="#">0123 06 10</a>	10	34	22.5	5	0.009
		R1/8	<a href="#">0123 07 10</a>	10	34	22.5	5	0.009
7	9	R1/4	<a href="#">0123 07 13</a>	14	38.5	22.5	6	0.018
		R3/8	<a href="#">0123 07 17</a>	17	39	22.5	6	0.024
		R1/8	<a href="#">0123 10 10</a>	13	34	22.5	5	0.014
10	12.2	R1/4	<a href="#">0123 10 13</a>	14	38.5	22.5	7	0.020
		R3/8	<a href="#">0123 10 17</a>	17	39	22.5	9.5	0.023
12	14	R3/8	<a href="#">0123 12 17</a>	17	46	29.5	11	0.026
		R1/4	<a href="#">0123 13 13</a>	17	45.5	29.5	7	0.026
13	15	R3/8	<a href="#">0123 13 17</a>	17	46	29.5	11	0.027
		R1/2	<a href="#">0123 13 21</a>	22	50.5	29.5	12	0.045
		R3/8	<a href="#">0123 16 17</a>	19	54.5	38	11	0.038
16	18.5	R1/2	<a href="#">0123 16 21</a>	22	59	38	14	0.054
		R3/4	<a href="#">0123 16 27</a>	27	62	38	15	0.084
		R3/8	<a href="#">0123 19 17</a>	22	54.5	38	11	0.047
19	21.5	R1/2	<a href="#">0123 19 21</a>	22	59	38	14	0.057
		R3/4	<a href="#">0123 19 27</a>	27	62	38	18	0.082
25	26.7	R3/4	<a href="#">0123 25 27</a>	27	62	38	18	0.078
	27	R1	<a href="#">0123 25 34</a>	36	65	38	24	0.126
32	34.5	R1	<a href="#">0123 32 34</a>	36	70	43	24	0.142

# Brass Adaptors

**0136**

## Tailpiece Adaptor for Flexible Tubing, Male BSPT Thread

Brass

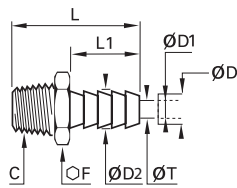

ØD	ØD1	ØD2	C		F	L	L1	ØT	Kg
6	4	4.3	R1/8	<a href="#">0136 06 10</a>	10	26.5	15	2	0.007
		4.3	R1/4	<a href="#">0136 06 13</a>	14	31	15	2	0.015
		4.3	R3/8	<a href="#">0136 06 17</a>	17	31.5	15	2	0.019
8	6	6.4	R1/8	<a href="#">0136 08 10</a>	10	26.5	15	4	0.007
		6.4	R1/4	<a href="#">0136 08 13</a>	14	31	15	4	0.015
		6.4	R3/8	<a href="#">0136 08 17</a>	17	31.5	15	4	0.020
10	8	8.4	R1/4	<a href="#">0136 10 13</a>	14	31	15	6	0.016
		8.4	R3/8	<a href="#">0136 10 17</a>	17	31.5	15	6	0.020
		8.4	R1/2	<a href="#">0136 10 21</a>	22	36	15	6	0.039
12	10	10.7	R1/4	<a href="#">0136 12 13</a>	14	36	20	7	0.018
		10.7	R3/8	<a href="#">0136 12 17</a>	17	36.5	20	8	0.023
		10.7	R1/2	<a href="#">0136 12 21</a>	22	41	20	8	0.040
14	12	12.7	R1/4	<a href="#">0136 14 13</a>	14	36	20	7	0.019
		12.7	R3/8	<a href="#">0136 14 17</a>	17	36.5	20	10	0.023
		12.7	R1/2	<a href="#">0136 14 21</a>	22	41	20	10	0.040
16	13	12.7	R3/4	<a href="#">0136 14 27</a>	27	44	20	10	0.071
		13.7	R3/8	<a href="#">0136 16 17</a>	17	36.5	20	11	0.023
		13.7	R1/2	<a href="#">0136 16 21</a>	22	41	20	11	0.040
		13.7	R3/4	<a href="#">0136 16 27</a>	27	44	20	11	0.071

# Nickel-Plated Brass Adaptors

## 0912 Equal Stud Elbow, Female BSPP and Metric Thread

Nickel-plated brass

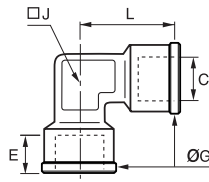

C		E	G	J	L	Kg
M5x0.8	<a href="#">0912 00 19</a>	4	8	9	11	0.006
G1/8	<a href="#">0912 00 10</a>	8	13	10	18.5	0.015
G1/4	<a href="#">0912 00 13</a>	11.5	17	12	22.5	0.028
G3/8	<a href="#">0912 00 17</a>	11.5	21	15	25.5	0.043
G1/2	<a href="#">0912 00 21</a>	14	26	19	30	0.074
G3/4	<a href="#">0912 00 27</a>	16.5	32	22	35.5	0.101
G1	<a href="#">0912 00 34</a>	18	38.5	28	40.5	0.168

## DD44BKTL

### 90° Bracketed Equal Elbow, Female BSPP Thread

Nickel-plated brass

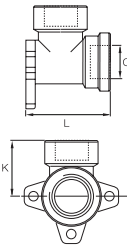

C		K	L	Kg
G1/2	<a href="#">1/2DD44BKTL</a>	27	40.5	0.061

## 0921 Equal Stud Elbow, Male/Female and Metric Thread

Nickel-plated brass

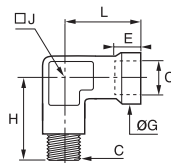

C		E	G	H	J	L	Kg
M5x0.8	<a href="#">0921 00 19</a>	4	8	11.5	9	11	0.007

## 0913 Equal Stud Elbow, Male BSPT/ Female BSPP Thread

Nickel-plated brass

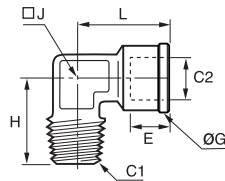

C1	C2		E	G	H	J	L	Kg
R1/8	G1/8	<a href="#">0913 00 10</a>	8	13	17	10	18.5	0.013
R1/4	G1/4	<a href="#">0913 00 13</a>	11.5	17	22.5	12	22.5	0.025
R3/8	G3/8	<a href="#">0913 00 17</a>	11.5	21	25.5	15	25.5	0.039
R1/2	G1/2	<a href="#">0913 00 21</a>	14	26	30	19	30	0.062
R3/4	G3/4	<a href="#">0913 00 27</a>	16.5	32	34.5	22	35.5	0.100
R1	G1	<a href="#">0913 00 34</a>	18	38.5	40.5	28	40.5	0.167

## 0922 Equal Stud Elbow, Male Metric Thread

Nickel-plated brass

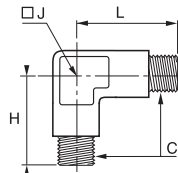

C		H	J	L	Kg
M5x0.8	<a href="#">0922 00 19</a>	11.5	9	11.5	0.010

# Nickel-Plated Brass Adaptors

## 0914 Equal Stud Elbow, Male BSPT Thread

Nickel-plated brass

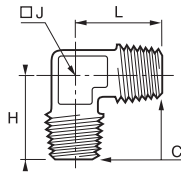

C		H	J	L	Kg
R1/8	<a href="#">0914 00 10</a>	17	10	17	0.010
R1/4	<a href="#">0914 00 13</a>	22.5	12	22.5	0.022
R3/8	<a href="#">0914 00 17</a>	25.5	15	25.5	0.034
R1/2	<a href="#">0914 00 21</a>	30	19	30	0.059
R3/4	<a href="#">0914 00 27</a>	34.5	22	34.5	0.104
R1	<a href="#">0914 00 34</a>	40.5	28	40.5	0.156

## 0910 Equal Y, Female BSPP Thread

Nickel-plated brass

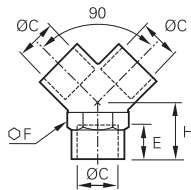

C		E	F	H	Kg
G1/8	<a href="#">0910 00 10</a>	8	13	12	0.018
G1/4	<a href="#">0910 00 13</a>	11	17	14	0.034
G3/8	<a href="#">0910 00 17</a>	11.5	20	16	0.045
G1/2	<a href="#">0910 00 21</a>	14	25	19	0.086

## 0911 Equal Y, Male BSPT/Female BSPP Thread

Nickel-plated brass

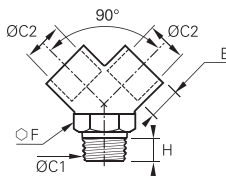

C1	C2		E	F	H	Kg
R1/8	G1/8	<a href="#">0911 00 10</a>	8	13	8	0.022
R1/4	G1/4	<a href="#">0911 00 13</a>	11	17	11	0.039
R3/8	G3/8	<a href="#">0911 00 17</a>	11.5	20	11.5	0.051
R1/2	G1/2	<a href="#">0911 00 21</a>	14	25	14	0.105

## 0915 Equal Tee, Female BSPP and Metric Thread

Nickel-plated brass

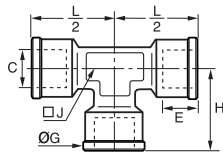

C		E	G	H	J	L/2	Kg
M5x0.8	<a href="#">0915 00 19</a>	5	8	11	9	11	0.010
G1/8	<a href="#">0915 00 10</a>	8	13	18.5	10	18.5	0.022
G1/4	<a href="#">0915 00 13</a>	11	17	22.5	12	22.5	0.042
G3/8	<a href="#">0915 00 17</a>	11.5	21	25.5	15	25.5	0.062
G1/2	<a href="#">0915 00 21</a>	14	26	30	19	30	0.099
G3/4	<a href="#">0915 00 27</a>	16.5	32	35.5	22	35.5	0.145
G1	<a href="#">0915 00 34</a>	18	38.5	40.5	28	40.5	0.233

## 0923 Equal Stud Branch Tee, Female/Male Metric Thread

Nickel-plated brass

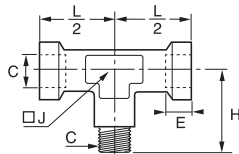

C		E	G	H	J	L/2	Kg
M5x0.8	<a href="#">0923 00 19</a>	4	8	11.5	9	11	0.009

# Nickel-Plated Brass Adaptors

## 0916 Equal Stud Branch Tee, Male BSPT/Female BSPP Thread

Nickel-plated brass

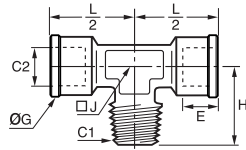

C1	C2		E	G	H	J	L/2	Kg
R1/8	G1/8	<a href="#">0916 00 10</a>	8	13	17	10	18	0.019
R1/4	G1/4	<a href="#">0916 00 13</a>	11	17	22.5	12	22.5	0.038
R3/8	G3/8	<a href="#">0916 00 17</a>	11.5	21	25.5	15	25.5	0.059
R1/2	G1/2	<a href="#">0916 00 21</a>	14	26	30	19	30	0.091
R3/4	G3/4	<a href="#">0916 00 27</a>	16.5	32	34.5	22	35	0.139
R1	G1	<a href="#">0916 00 34</a>	18	38.5	40.5	28	40.5	0.237

## 0924 Equal Stud Run Tee, Female/Male Metric Thread

Nickel-plated brass

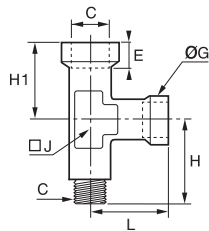

C		E	G	H	H1	J	L	Kg
M5x0.8	<a href="#">0924 00 19</a>	4	8	12	11	9	11	0.009

## 0917 Equal Stud Run Tee, Female BSPP/Male BSPT Thread

Nickel-plated brass

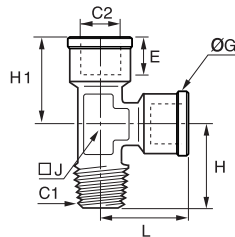

C1	C2		E	G	H	H1	J	L	Kg
R1/8	G1/8	<a href="#">0917 00 10</a>	8	13	17	18.5	10	18.5	0.018
R1/4	G1/4	<a href="#">0917 00 13</a>	11	17	22.5	22.5	12	22.5	0.038
R3/8	G3/8	<a href="#">0917 00 17</a>	11.5	21	25.5	25.5	15	25.5	0.057
R1/2	G1/2	<a href="#">0917 00 21</a>	14	26	30	30	19	30	0.090
R3/4	G3/4	<a href="#">0917 00 27</a>	16.5	32	34.5	35.5	22	35.5	0.137
R1	G1	<a href="#">0917 00 34</a>	18	38.5	40.5	40.5	28	40.5	0.219

## 0927 Equal Tee, Male BSPT Thread

Nickel-plated brass

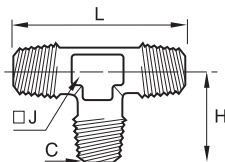

C		H	J	L	Kg
R1/8	<a href="#">0927 00 10</a>	17	10	34	0.013
R1/4	<a href="#">0927 00 13</a>	22.5	12	45	0.032
R3/8	<a href="#">0927 00 17</a>	25.5	15	51	0.056
R1/2	<a href="#">0927 00 21</a>	30	19	60	0.094
R3/4	<a href="#">0927 00 27</a>	34.5	22	69	0.133
R1	<a href="#">0927 00 34</a>	40.5	28	81	0.217

## 0928 Equal Stud Branch Tee, Male BSPT/ Female BSPP Thread

Nickel-plated brass

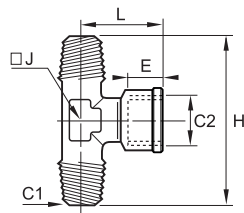

C1	C2		E	H	J	L	Kg
R1/8	G1/8	<a href="#">0928 00 10</a>	8	34	10	18.5	0.016
R1/4	G1/4	<a href="#">0928 00 13</a>	11	45	12	22.5	0.035
R3/8	G3/8	<a href="#">0928 00 17</a>	11.5	51	15	25.5	0.053
R1/2	G1/2	<a href="#">0928 00 21</a>	14	60	19	30	0.087
R3/4	G3/4	<a href="#">0928 00 27</a>	16.5	69	22	35.5	0.236
R1	G1	<a href="#">0928 00 34</a>	18	81	28	40.5	0.225



# Nickel-Plated Brass Adaptors

## 0932 Equal Stud Run Tee, Male BSPT/Female BSPP Thread

Nickel-plated brass

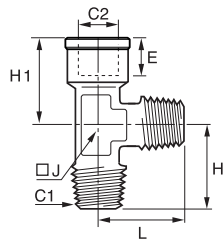

C1	C2		E	H	H1	J	L	Kg
R1/8	G1/8	<a href="#">0932 00 10</a>	8	17	18.5	10	17	0.016
R1/4	G1/4	<a href="#">0932 00 13</a>	11	22.5	22.5	12	22.5	0.035
R3/8	G3/8	<a href="#">0932 00 17</a>	11.5	25.5	25.5	15	25.5	0.055
R1/2	G1/2	<a href="#">0932 00 21</a>	14	30	30	19	30	0.091
R3/4	G3/4	<a href="#">0932 00 27</a>	16.5	34.5	35.5	22	34.5	0.080
R1	G1	<a href="#">0932 00 34</a>	18	40.5	40.5	28	40.5	0.226

## 0908 Equal Cross, Female BSPP Thread

Nickel-plated brass

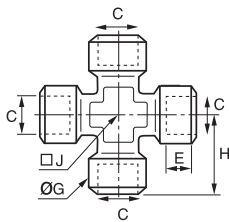

C		E	G	H	J	Kg
G1/8	<a href="#">0908 00 10</a>	8	13	21	10	0.038
G1/4	<a href="#">0908 00 13</a>	11	17	25.5	13	0.075
G3/8	<a href="#">0908 00 17</a>	11.5	21	28	17	0.108
G1/2	<a href="#">0908 00 21</a>	14	26	33.5	21	0.184

## 0909 Equal Cross, Male BSPT/Female BSPP Thread

Nickel-plated brass

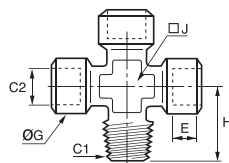

C1	C2		E	G	H	J	Kg
R1/8	G1/8	<a href="#">0909 00 10</a>	8	13	18.5	10	0.034
R1/4	G1/4	<a href="#">0909 00 13</a>	11	17	23.5	13	0.069
R3/8	G3/8	<a href="#">0909 00 17</a>	11.5	21	26	17	0.098
R1/2	G1/2	<a href="#">0909 00 21</a>	14	26	31	21	0.167

## KRRS3 Equal Cross, Male BSPT Thread

Nickel-plated brass

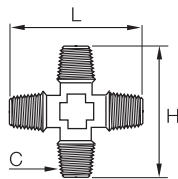

C		H	L	Kg
R1/4	<a href="#">1/4KRRS3BL</a>	47	47	0.046

## 0903 Reducer, Male/Female BSPP Thread

Nickel-plated brass

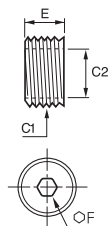

C1	C2		E	F	Kg
G1/4	G1/8	<a href="#">0903 10 13</a>	8	6	0.004
G3/8	G1/4	<a href="#">0903 13 17</a>	9	8	0.007
G1/2	G3/8	<a href="#">0903 17 21</a>	10	10	0.011
G3/4	G1/2	<a href="#">0903 21 27</a>	14	12	0.022
G1	G3/4	<a href="#">0903 27 34</a>	20	17	0.037

# Nickel-Plated Brass Adaptors

## 0904 Reducer, Male BSPT/Female BSPP Thread

Nickel-plated brass

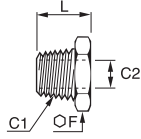

C1	C2		F	L	Kg
R1/4	G1/8	0904 10 13	14	16	0.010
R3/8	G1/8	0904 10 17	17	16.5	0.021
R1/2	G1/8	0904 10 21	22	19.5	0.046
R3/8	G1/4	0904 13 17	17	16.5	0.015
	G1/4	0904 13 21	22	19.5	0.033
R1/2	G3/8	0904 17 21	22	19.5	0.024
	G3/8	0904 17 27	27	23	0.057
R3/4	G1/2	0904 21 27	27	23	0.045
	G1/2	0904 21 34	34	27	0.103
R1	G3/4	0904 27 34	34	27	0.770

## 0905 Reducer, Male BSPP/Female BSPP and Metric Thread

Nickel-plated brass

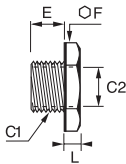

C1	C2		E	F	L	Kg
G1/8	M5x0.8	0905 19 10*	6	14	4.5	0.008
G1/4	G1/8	0905 10 13*	8	17	5	0.011
G3/8	G1/8	0905 10 17*	9	19	5	0.019
G1/2	G1/8	0905 10 21	10	24	5.5	0.034
G3/8	G1/4	0905 13 17	9	19	5	0.013
	G1/4	0905 13 21	10	24	5.5	0.032
G1/2	G3/8	0905 17 21	10	24	5.5	0.021
	G3/8	0905 17 27	11	30	6.5	0.054
G3/4	G1/2	0905 21 27*	11	30	6.5	0.040

\*Please contact us for detailed drawings of external thread.

## 0906 Increaser, Male BSPP and Metric/Female BSPP Thread

Nickel-plated brass

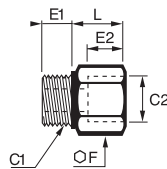

C1	C2		E1	E2	F	L	Kg
M5x0.8	G1/8	0906 10 19	4	8	14	10.5	0.010
	G1/8	0906 00 10	6	8	14	10.5	0.011
G1/8	G1/4	0906 10 13	6	11	17	13.5	0.017
	G3/8	0906 10 17	6	11.5	22	14.5	0.030
	G1/4	0906 00 13	8	11	17	13.5	0.019
G1/4	G3/8	0906 13 17	8	11.5	22	14.5	0.032
	G1/2	0906 13 21	8	14	24	18	0.037
G3/8	G3/8	0906 00 17	9	11.5	22	14.5	0.034
	G1/2	0906 17 21	9	14	24	18	0.038
G1/2	G1/2	0906 00 21	10	14	26	20	0.053

## 0933 Increaser, Male BSPT/Female BSPP Thread

Nickel-plated brass

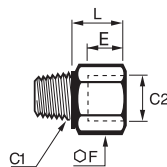



C1	C2		F	L	Kg
R1/8	G1/8	0933 00 10	14	10	0.011
R1/4	G1/4	0933 00 13	17	13.5	0.021
R3/8	G3/8	0933 00 17	22	14.5	0.037
R1/2	G1/2	0933 00 21	26	18	0.059
R1/8	G1/4	0933 10 13	17	13.5	0.018
	G3/8	0933 10 17	22	14.5	0.029
R1/4	G3/8	0933 13 17	22	14.5	0.034
	G1/2	0933 13 21	24	18	0.045
R3/8	G1/2	0933 17 21	24	18	0.030
R1/2	G3/4	0933 21 27	32	23.5	0.080

# Nickel-Plated Brass Adaptors

## 0907 Equal Extended Adaptor, Male/Female BSPP Thread

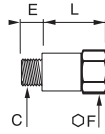
Nickel-plated brass



C		E	F	L	Kg
G1/8	<a href="#">0907 00 10</a>	6	14	16	0.015
	<a href="#">0907 00 10 01</a>	6	14	36	0.030
G1/4	<a href="#">0907 00 13</a>	8	17	27	0.032
	<a href="#">0907 00 13 01</a>	8	17	43	0.047

## 0920 Bulkhead Connector, Female BSPP and Metric Thread

Nickel-plated brass

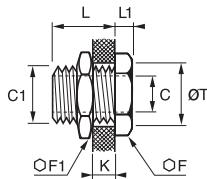

C	C1		F	F1	K <sub>max</sub>	L	L1	ØT	Kg
M5x0.8	M10x1	<a href="#">0920 00 19</a>	14	14	7	10.5	3.5	10.5	0.012
G1/8	M16x1.5	<a href="#">0920 00 10</a>	19	22	10	14	4	16.5	0.029
G1/4	M20x1.5	<a href="#">0920 00 13</a>	24	27	16	21	4	20.5	0.056
G3/8	M26x1.5	<a href="#">0920 00 17</a>	30	32	15	21	5	26.5	0.094
G1/2	M28x1.5	<a href="#">0920 00 21</a>	32	36	21	27	6	28.5	0.115

## 0900 Equal and Unequal Adaptor, Male BSPT Thread

Nickel-plated brass

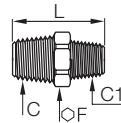

C1	C2		F	L	Kg
R1/8	R1/8	<a href="#">0900 00 10</a>	12	20.5	0.009
	R1/4	<a href="#">0900 10 13</a>	14	24	0.015
	R3/8	<a href="#">0900 10 17</a>	17	24.5	0.020
R1/4	R1/4	<a href="#">0900 00 13</a>	14	27	0.019
	R3/8	<a href="#">0900 13 17</a>	17	27.5	0.025
R3/8	R1/2	<a href="#">0900 13 21</a>	22	30.5	0.045
	R3/8	<a href="#">0900 00 17</a>	17	28	0.025
	R1/2	<a href="#">0900 17 21</a>	22	31	0.045
R1/2	R1/2	<a href="#">0900 00 21</a>	22	33.5	0.044
	R3/4	<a href="#">0900 21 27</a>	27	37	0.083
R3/4	R3/4	<a href="#">0900 00 27</a>	27	39.5	0.079
	R1	<a href="#">0900 27 34</a>	34	42.5	0.143
R1	R1	<a href="#">0900 00 34</a>	34	45.5	0.152

## 0901 Equal and Unequal Adaptor, Male BSPP and Metric Thread

Nickel-plated brass

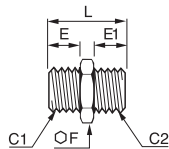

C1	C2		E	E1	F	L	Kg
M5x0.8	M5x0.8	<a href="#">0901 00 19</a>	4	4	8	11.5	0.002
	G1/8	<a href="#">0901 19 10</a>	4	6	14	14.5	0.008
G1/8	G1/8	<a href="#">0901 00 10</a>	6	6	14	16.5	0.009
	G1/4	<a href="#">0901 10 13</a>	6	8	17	19	0.016
	G3/8	<a href="#">0901 10 17</a>	6	9	19	20	0.020
G1/4	G1/4	<a href="#">0901 00 13</a>	8	8	17	21	0.019
	G3/8	<a href="#">0901 13 17</a>	8	9	19	22	0.023
G3/8	G1/2	<a href="#">0901 13 21</a>	8	10	24	23.5	0.036
	G3/8	<a href="#">0901 00 17</a>	9	9	19	23	0.025
G1/2	G1/2	<a href="#">0901 17 21</a>	9	10	24	24.5	0.038
	G1/2	<a href="#">0901 00 21</a>	10	10	24	25.5	0.039
G1/2	G3/4	<a href="#">0901 21 27</a>	10	12	30	27.5	0.062

# Nickel-Plated Brass Adaptors

## 0192 Unequal Straight Adaptor, Male BSPT/BSPP Thread

Nickel-plated brass

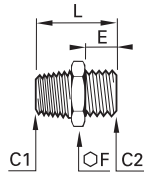

C1	C2		E	F	L	Kg
R1/8	G1/4	<a href="#">0192 10 13</a>	9.5	17	23.5	0.019
R1/4	G1/4	<a href="#">0192 13 13</a>	9.5	17	27.5	0.024
	G1/2	<a href="#">0192 13 21</a>	11	27	31.5	0.068
R3/8	G1/4	<a href="#">0192 17 13</a>	9.5	17	28	0.025
	G1/2	<a href="#">0192 17 21</a>	11	27	31.5	0.060
R1/2	G1/2	<a href="#">0192 21 21</a>	11	27	34	0.061

## 0902 Equal and Unequal Adaptor, Female BSPP and Metric Thread

Nickel-plated brass

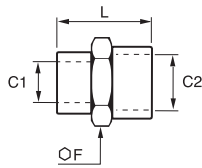

C1	C2		F	L	Kg
M5x0.8	M5x0.8	<a href="#">0902 00 19</a>	8	11	0.003
	G1/8	<a href="#">0902 19 10</a>	14	13.5	0.009
G1/8	G1/8	<a href="#">0902 00 10</a>	14	15	0.010
	G1/4	<a href="#">0902 10 13</a>	17	19	0.017
	G3/8	<a href="#">0902 10 17</a>	22	20	0.027
	G1/2	<a href="#">0902 10 21</a>	24	20	0.015
G1/4	G1/4	<a href="#">0902 00 13</a>	17	22	0.020
	G3/8	<a href="#">0902 13 17</a>	22	22.5	0.030
	G1/2	<a href="#">0902 13 21</a>	26	24	0.033
G3/8	G3/8	<a href="#">0902 00 17</a>	22	23	0.033
	G1/2	<a href="#">0902 17 21</a>	24	26	0.036
G1/2	G1/2	<a href="#">0902 00 21</a>	26	28	0.048
	G3/4	<a href="#">0902 21 27</a>	32	30	0.077
	G1	<a href="#">0902 21 34</a>	40	39	0.145
G3/4	G3/4	<a href="#">0902 00 27</a>	32	32	0.076
	G1	<a href="#">0902 27 34</a>	40	41	0.146

## 0191 Tailpiece Adaptor for Rubber Hose, Male BSPP Thread

Nickel-plated brass

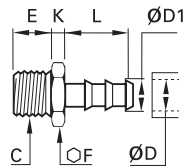

ØD	ØD1	C		E	F	K	L	Kg
4	6	G1/4	<a href="#">0191 04 13</a>	9.5	17	5	22.5	0.019
		G1/4	<a href="#">0191 07 13</a>	9.5	17	5	22.5	0.022
7	9	G1/2	<a href="#">0191 07 21</a>	11	27	7	29.5	0.056
		G1/4	<a href="#">0191 10 13</a>	9.5	17	5	22.5	0.020
10	12.2	G1/2	<a href="#">0191 10 21</a>	11	27	7	29.5	0.060
		G1/4	<a href="#">0191 13 13</a>	9.5	17	5	22.5	0.022
13	15.2	G1/2	<a href="#">0191 13 21</a>	11	27	7	29.5	0.059
		G1/2	<a href="#">0191 16 21</a>	11	27	7	36.5	0.068

## 0931 Tailpiece Adaptor for Rubber Hose, Male BSPP Thread

Nickel-plated brass

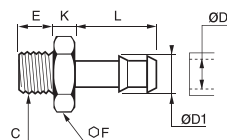

ØD	ØD1	C		E	F	K	L	Kg
4	4.5	M5x0.8	<a href="#">0931 04 19</a>	4	8	4	15	0.003
		G1/8	<a href="#">0931 06 10</a>	6	12	4.5	19	0.009
6	7	G1/4	<a href="#">0931 06 13</a>	8	14	5	19	0.013
		G1/8	<a href="#">0931 07 10</a>	6	12	4	19	0.009
		G1/4	<a href="#">0931 07 13</a>	8	14	5	19	0.013
7	8	G3/8	<a href="#">0931 07 17</a>	9	19	5	19	0.022
		G1/8	<a href="#">0931 08 10</a>	6	12	4	19	0.009
		G1/4	<a href="#">0931 08 13</a>	8	14	5	19	0.014
8	9	G3/8	<a href="#">0931 08 17</a>	9	19	5	19	0.022
		G1/4	<a href="#">0931 10 13</a>	8	14	5	19	0.016
		G3/8	<a href="#">0931 10 17</a>	9	19	5	19	0.023
10	12	G1/2	<a href="#">0931 10 21</a>	10	22	6	20	0.031
		G3/8	<a href="#">0931 15 17</a>	9	19	6	24	0.030
15	17	G1/2	<a href="#">0931 15 21</a>	10	22	6	24	0.038
		G1/2	<a href="#">0931 18 21</a>	10	22	6	24	0.040

# Nickel-Plated Brass Adaptors

## 0934

### Tailpiece Adaptor for Polymer Tubing, Male BSPT Thread

Nickel-plated brass

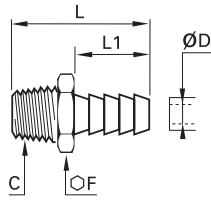

ØD	C		F	L	L1	Kg
6	R1/8	<a href="#">0934 06 10</a>	12	31.5	19	0.009
	R1/4	<a href="#">0934 06 13</a>	14	35	19	0.014
7	R1/8	<a href="#">0934 07 10</a>	12	31.5	19	0.009
	R1/4	<a href="#">0934 07 13</a>	14	35	19	0.014
8	R1/8	<a href="#">0934 08 10</a>	12	31.5	19	0.010
	R1/4	<a href="#">0934 08 13</a>	14	35	19	0.015
9	R1/8	<a href="#">0934 09 10</a>	12	31.5	19	0.012
	R1/4	<a href="#">0934 09 13</a>	14	35	19	0.015
	R3/8	<a href="#">0934 09 17</a>	17	35.5	19	0.021
10	R1/2	<a href="#">0934 09 21</a>	22	38.5	19	0.032
	R1/8	<a href="#">0934 10 10</a>	12	32.5	20	0.010
	R1/4	<a href="#">0934 10 13</a>	14	36	20	0.015
12	R3/8	<a href="#">0934 10 17</a>	17	36.5	20	0.022
	R1/2	<a href="#">0934 10 21</a>	22	39.5	20	0.033
	R1/4	<a href="#">0934 12 13</a>	14	36	20	0.019
14	R3/8	<a href="#">0934 12 17</a>	17	36.5	20	0.021
	R1/2	<a href="#">0934 12 21</a>	22	39.5	20	0.033
16	R3/8	<a href="#">0934 14 17</a>	17	38.5	22	0.023
	R1/2	<a href="#">0934 14 21</a>	22	41.5	22	0.036
17	R3/8	<a href="#">0934 16 17</a>	17	38.5	22	0.026
	R1/2	<a href="#">0934 16 21</a>	22	41.5	22	0.038
18	R3/4	<a href="#">0934 16 27</a>	27	45	22	0.062
	R3/8	<a href="#">0934 17 17</a>	18	40.5	24	0.030
	R1/2	<a href="#">0934 17 21</a>	22	43.5	24	0.043
20	R3/8	<a href="#">0934 18 17</a>	19	40.5	24	0.031
	R1/2	<a href="#">0934 18 21</a>	22	43.5	24	0.043
	R3/4	<a href="#">0934 18 27</a>	27	47	24	0.062
20	R3/8	<a href="#">0934 20 17</a>	22	41	24	0.038
	R1/2	<a href="#">0934 20 21</a>	22	43.5	24	0.046

## 0935

### Tailpiece Adaptor for Polymer Tubing, Male BSPP Thread

Nickel-plated brass

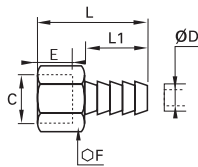

ØD	C		E	F	L	L1	Kg
6	G1/8	<a href="#">0935 06 10</a>	8	12	28.5	19	0.007
7	G1/8	<a href="#">0935 07 10</a>	8	12	28.5	19	0.012
8	G1/4	<a href="#">0935 08 13</a>	11	15	31.5	19	0.019
9	G1/4	<a href="#">0935 09 13</a>	11	15	31.5	19	0.020
	G3/8	<a href="#">0935 09 17</a>	11.5	19	32	19	0.025
10	G3/8	<a href="#">0935 10 17</a>	11.5	19	33	20	0.025
12	G3/8	<a href="#">0935 12 17</a>	11.5	19	33	20	0.027
	G1/2	<a href="#">0935 12 21</a>	14.5	24	36	20	0.040

# Stainless Steel Adaptors

## 1844 Equal Stud Elbow, Male BSPT/Female BSPP Thread

Stainless steel 316L

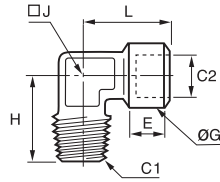

C1	C2		E	G	H	J	L	Kg
R1/8	G1/8	<a href="#">1844 10 10</a>	7.5	15	20.5	10	22.5	0.022
R1/4	G1/4	<a href="#">1844 13 13</a>	12	18.5	27.5	12	26.5	0.047
R3/8	G3/8	<a href="#">1844 17 17</a>	12	23.5	28	14	30	0.069
R1/2	G1/2	<a href="#">1844 21 21</a>	15	28	38	18	38	0.116
R3/4	G3/4	<a href="#">1844 27 27</a>	16.5	33	41	22	44.5	0.158
R1	G1	<a href="#">1844 34 34</a>	19	40	48	32	50	0.312

## 1843 Equal Elbow, Female BSPP Thread

Stainless steel 316L

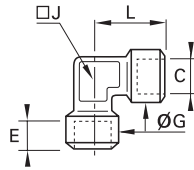

C		E	G	J	L	Kg
G1/8	<a href="#">1843 10 10</a>	7.5	17.5	12	22.5	0.042
G1/4	<a href="#">1843 13 13</a>	11	18.5	15	26.5	0.053
G3/8	<a href="#">1843 17 17</a>	11.5	23.5	18	29	0.079
G1/2	<a href="#">1843 21 21</a>	15	28	23	38	0.157
G3/4	<a href="#">1843 27 27</a>	16.5	33	22	43.5	0.209
G1	<a href="#">1843 34 34</a>	19	40	32	52	0.444

## 1845 Equal Tee, Female BSPP Thread

Stainless steel 316L

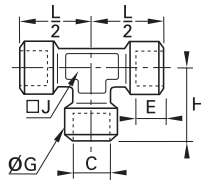

C		E	G	H	J	L/2	Kg
G1/8	<a href="#">1845 10 10</a>	7.5	17.5	22.5	12	22.5	0.058
G1/4	<a href="#">1845 13 13</a>	11	18.5	26.5	15	26.5	0.076
G3/8	<a href="#">1845 17 17</a>	11.5	23.5	29	18	29	0.102
G1/2	<a href="#">1845 21 21</a>	15	28	38	23	38	0.218
G3/4	<a href="#">1845 27 27</a>	16.5	33	43.5	22	43.5	0.301
G1	<a href="#">1845 34 34</a>	19	40	50	32	50	0.446

## 1817 Equal Bulkhead Adaptor, Female BSPP Thread

Stainless steel 316L

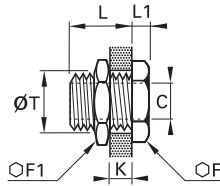

C		F	F1	K <sub>max</sub>	L	L1	ØT <sub>min</sub>	Kg
G1/8	<a href="#">1817 00 10</a>	19	22	9	14	4	16.5	0.031
G1/4	<a href="#">1817 00 13</a>	24	27	15	21	4	20.5	0.053
G3/8	<a href="#">1817 00 17</a>	30	32	14	21	5	26.5	0.090
G1/2	<a href="#">1817 00 21</a>	32	36	20	27	6	28.5	0.108
G3/4	<a href="#">1817 00 27</a>	41	41	22.5	30	6	34.5	0.152
G1	<a href="#">1817 00 34</a>	46	50	24.5	34	8	42.5	0.251

## 1871 Equal Bulkhead Adaptor, Female NPT Thread

Stainless steel 316L

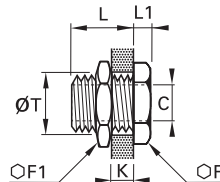

C		F	F1	K <sub>max</sub>	L	L1	ØT <sub>min</sub>	Kg
NPT1/8	<a href="#">1871 00 11</a>	19	22	9	14	5	16.5	0.031
NPT1/4	<a href="#">1871 00 14</a>	24	22	9	14	5	16.5	0.060
NPT3/8	<a href="#">1871 00 18</a>	30	32	18	23	5	26.5	0.096
NPT1/2	<a href="#">1871 00 22</a>	32	36	22	29	6	28.5	0.119

# Stainless Steel Adaptors

## 1855 Equal Connector, Female BSPP Thread

Stainless steel 316L

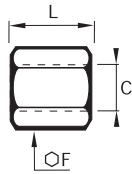

C		F	L	Kg
G1/8	<a href="#">1855 10 10</a>	14	17	0.013
G1/4	<a href="#">1855 13 13</a>	17	24	0.023
G3/8	<a href="#">1855 17 17</a>	22	25	0.042
G1/2	<a href="#">1855 21 21</a>	27	32	0.079
G3/4	<a href="#">1855 27 27</a>	14	35	0.102
G1	<a href="#">1855 34 34</a>	41	40	0.202

## 1870 Equal Connector, Female NPT Thread

Stainless steel 316L

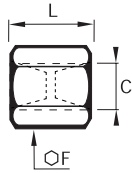

C		F	L	Kg
NPT1/8	<a href="#">1870 11 11</a>	14	19	0.015
NPT1/4	<a href="#">1870 14 14</a>	17	28	0.029
NPT3/8	<a href="#">1870 18 18</a>	22	28	0.050
NPT1/2	<a href="#">1870 22 22</a>	27	35	0.092

## 1862 Reducer Connector, Female BSPP Thread

Stainless steel 316L

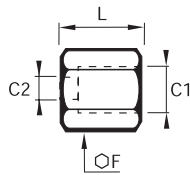

C1	C2		F	L	Kg
G1/4	G1/8	<a href="#">1862 13 10</a>	17	20.5	0.024
G3/8	G1/8	<a href="#">1862 17 10</a>	22	21	0.043
	G1/4	<a href="#">1862 17 13</a>	22	24.5	0.048
G1/2	G1/4	<a href="#">1862 21 13</a>	27	28.5	0.086
	G3/8	<a href="#">1862 21 17</a>	27	29	0.081
G3/4	G1/2	<a href="#">1862 27 21</a>	32	39.5	0.148
G1	G3/4	<a href="#">1862 34 27</a>	41	45	0.281

## 1864 Adaptor, Male NPT/Female BSPP Thread

Stainless steel 316L

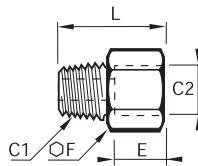

C1	C2		E	F	L	Kg
NPT1/8	G1/8	<a href="#">1864 11 10</a>	7.5	14	21.5	0.015
NPT1/4	G1/4	<a href="#">1864 14 13</a>	11	17	30	0.028
NPT3/8	G3/8	<a href="#">1864 18 17</a>	11.5	22	31	0.043
NPT1/2	G1/2	<a href="#">1864 22 21</a>	15	27	39.5	0.081

## 1867 Adaptor, Male BSPT/Female NPT Thread

Stainless steel 316L

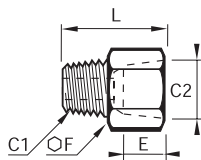

C1	C2		E	F	L	Kg
R1/8	NPT1/8	<a href="#">1867 10 11</a>	8	14	21	0.015
R1/4	NPT1/4	<a href="#">1867 13 14</a>	11.5	17	28.5	0.028
R3/8	NPT3/8	<a href="#">1867 17 18</a>	12	22	29.5	0.044
R1/2	NPT1/2	<a href="#">1867 21 22</a>	15.5	27	37.5	0.083

# Stainless Steel Adaptors

## 1863 Reducer, Male BSPT/Female BSPP Thread

Stainless steel 316L

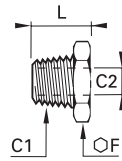

C1	C2		F	L	Kg
R1/4	G1/8	<a href="#">1863 13 10</a>	14	16	0.008
R3/8	G1/8	<a href="#">1863 17 10</a>	17	16.5	0.019
	G1/4	<a href="#">1863 17 13</a>	17	16.5	0.011
R1/2	G1/4	<a href="#">1863 21 13</a>	22	21	0.035
	G3/8	<a href="#">1863 21 17</a>	22	21	0.023
R3/4	G1/2	<a href="#">1863 27 21</a>	27	25.5	0.045
R1	G3/4	<a href="#">1863 34 27</a>	36	28.5	0.083

## 1872 Reducer, Male/Female NPT Thread

Stainless steel 316L

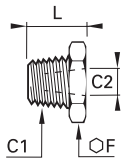

C1	C2		F	L	Kg
NPT1/4	NPT1/8	<a href="#">1872 14 11</a>	14	16	0.010
NPT3/8	NPT1/8	<a href="#">1872 18 11</a>	19	16.5	0.023
	NPT1/4	<a href="#">1872 18 14</a>	19	16.5	0.016
NPT1/2	NPT1/4	<a href="#">1872 22 14</a>	22	21	0.039
	NPT3/8	<a href="#">1872 22 18</a>	22	21	0.027

## 1861 Increaser, Male BSPT/Female BSPP Thread

Stainless steel 316L

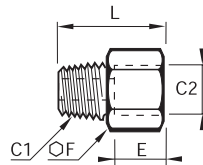

C1	C2		E	F	L	Kg
R1/8	G1/4	<a href="#">1861 10 13</a>	11	17	24	0.022
	G3/8	<a href="#">1861 10 17</a>	11.5	22	25	0.038
R1/4	G3/8	<a href="#">1861 13 17</a>	11.5	22	28.5	0.042
	G1/2	<a href="#">1861 13 21</a>	15	27	32.5	0.069
R3/8	G1/2	<a href="#">1861 17 21</a>	15	27	33	0.070
R1/2	G3/4	<a href="#">1861 21 27</a>	16.5	32	38	0.093
R3/4	G1	<a href="#">1861 27 34</a>	19	41	43.5	0.182

## 1873 Increaser, Male/Female NPT Thread

Stainless steel 316L

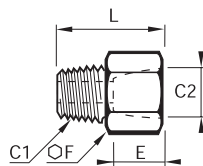

C1	C2		E	F	L	Kg
NPT1/8	NPT1/4	<a href="#">1873 11 14</a>	14	17	25	0.024
	NPT3/8	<a href="#">1873 11 18</a>	14	22	25	0.039
NPT1/4	NPT3/8	<a href="#">1873 14 18</a>	14	22	28.5	0.042
	NPT1/2	<a href="#">1873 14 22</a>	17.5	27	31	0.064
NPT3/8	NPT1/2	<a href="#">1873 18 22</a>	17.5	27	31.5	0.064

## 1821 Equal and Unequal Adaptor, Male BSPT Thread

Stainless steel 316L

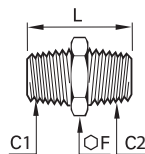

C1	C2		F	L	Kg
R1/8	R1/8	<a href="#">1821 10 10</a>	12	19	0.009
R1/4	R1/8	<a href="#">1821 13 10</a>	14	23.5	0.015
	R1/4	<a href="#">1821 13 13</a>	14	27	0.019
R3/8	R1/4	<a href="#">1821 17 13</a>	17	27.5	0.024
	R3/8	<a href="#">1821 17 17</a>	17	28	0.023
R1/2	R3/8	<a href="#">1821 21 17</a>	22	32.5	0.042
	R1/2	<a href="#">1821 21 21</a>	22	36	0.047
R3/4	R1/2	<a href="#">1821 27 21</a>	27	41	0.079
	R3/4	<a href="#">1821 27 27</a>	27	42	0.088
R1	R3/4	<a href="#">1821 34 27</a>	36	46	0.142
	R1	<a href="#">1821 34 34</a>	36	48	0.146



# Stainless Steel Adaptors

## 1821 Equal Adaptor, Male NPT Thread

Stainless steel 316L

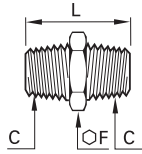

C		F	L	Kg
NPT1/8	<a href="#">1821 11 11</a>	12	23	0.011
NPT1/4	<a href="#">1821 14 14</a>	14	32	0.023
NPT3/8	<a href="#">1821 18 18</a>	19	33	0.031
NPT1/2	<a href="#">1821 22 22</a>	22	42	0.056
NPT3/4	<a href="#">1821 28 28</a>	27	40	0.081
NPT1	<a href="#">1821 35 35</a>	36	46	0.136

## 1823 Tailpipe Adaptor for Rubber Hose, Male BSPT Thread

Stainless steel 316L

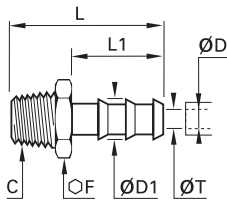

ØD	ØD1	C		F	L	L1	ØT	Kg
7	9	R1/8	<a href="#">1823 07 10</a>	10	34	22.5	5	0.009
		R1/4	<a href="#">1823 07 13</a>	14	38.5	22.5	6	0.017
10	12.2	R1/4	<a href="#">1823 10 13</a>	14	38.5	22.5	7	0.018
		R3/8	<a href="#">1823 10 17</a>	17	39	22.5	9.5	0.021
13	15	R3/8	<a href="#">1823 13 17</a>	17	46	29.5	11	0.025
16	18.5	R1/2	<a href="#">1823 16 21</a>	22	59	38	14	0.049

## 1823 Tailpipe Adaptor for Rubber Hose, Male NPT Thread

Stainless steel 316L

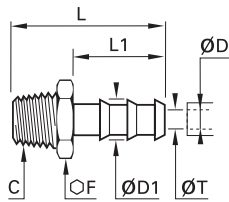

ØD	ØD1	C		F	L	L1	ØT	Kg
1/4	8.3	NPT1/8	<a href="#">1823 56 11</a>	12	34	22.5	5.3	0.010
		NPT1/4	<a href="#">1823 56 14</a>	14	38.5	22.5	5.3	0.016
3/8	11.7	NPT1/4	<a href="#">1823 60 14</a>	14	38.5	22.5	8.5	0.018
		NPT3/8	<a href="#">1823 60 18</a>	19	39	22.5	8.5	0.026

# Brass Manifolds

**0135**

Manifold Block, Female BSP Thread

Brass

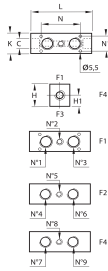

	<b>C</b>		<b>H</b>	<b>H1</b>	<b>K</b>	<b>L</b>	<b>N</b>	<b>Kg</b>
G1/4		<b>0135 06 13</b>	30	13	25	70	37	0.335
		<b>0135 09 13</b>	30	13	25	87	54	0.409
G1/2		<b>0135 06 21</b>	40	16	35	86	45	0.714
		<b>0135 09 21</b>	40	16	35	109	68	0.899
G3/4		<b>0135 10 27</b>	45	21	40	122	78	1.232

This product is designed to distribute in several directions.

The number of ports can be increased by using tee pieces, cross pieces or double banjo couplings.

## Installation Options

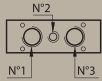
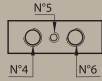
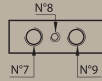
	 F1			 F2				 F4				
	Number of Outlets	N°1	N°2	N°3	Number of Outlets	N°4	N°5	N°6	Number of Outlets	N°7	N°8	N°9
<b>0135 06 13</b>	1		G1/4		2	G1/8		G1/8	2	G1/8		G1/8
<b>0135 09 13</b>	2	G1/4		G1/4	3	G1/8	G1/8	G1/8	3	G1/8	G1/8	G1/8
<b>0135 06 21</b>	1		G1/2		2	G1/4		G1/4	2	G1/8		G1/8
<b>0135 09 21</b>	2	G1/2		G1/2	3	G1/4	G1/4	G1/4	3	G1/8	G1/8	G1/8
<b>0135 10 27</b>	3	G1/2	G1/8	G1/2	3	G1/8	G1/8	G1/8	3	G1/4	G1/8	G1/4

# Anodised Aluminium Manifolds

## 3310 In-Line Manifold

Treated aluminium, NBR

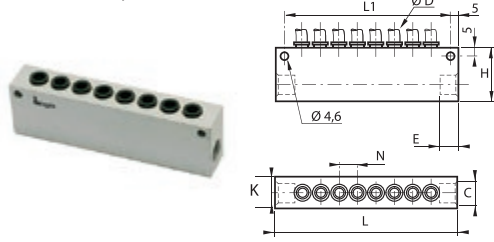

ØD	C		Number of Outlets	E	H	K	L	L1	N	Kg
4	G1/4	<a href="#">3310 04 13</a>	8	10	33	20	114	104	11.5	0.164
6	G1/4	<a href="#">3310 06 13</a>	8	10	33	20	114	104	12.5	0.170
8	G3/8	<a href="#">3310 08 17</a>	6	12	33	20	114	104	15	0.148
10	G1/2	<a href="#">3310 10 21</a>	6	16	48	25	145.5	135.5	17	0.334
12	G1/2	<a href="#">3310 12 21</a>	6	16	45	25	158	148	20.5	0.370

## 3311 Manifold, Female BSPP and Metric Thread

Treated aluminium

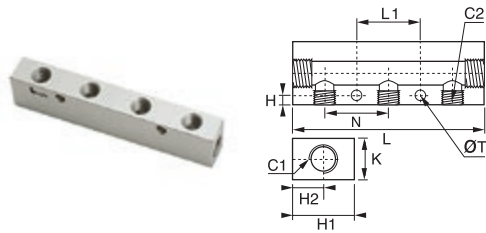

C1	C2		Number of Outlets	H	H1	H2	K	L	L1	N	ØT	Kg
G1/8	M5x0.8	<a href="#">3311 19 10 07</a>	7	3.5	20	8.5	15	95	80	11	4.4	0.067
		<a href="#">3311 10 13 02</a>	2	4.5	30	15	20	61	50	30	5	0.074
		<a href="#">3311 10 13 03</a>	3	4.5	30	15	20	91	30	30	5	0.121
G1/4	G1/8	<a href="#">3311 10 13 04</a>	4	4.5	30	15	20	121	60	30	5	0.165
		<a href="#">3311 10 13 05</a>	5	4.5	30	15	20	151	90	30	5	0.209
		<a href="#">3311 10 13 06</a>	6	4.5	30	15	20	181	120	30	5	0.244
G3/8	G1/4	<a href="#">3311 13 17 02</a>	2	5.5	30	11	20	74	61	36	6.5	0.076
		<a href="#">3311 13 17 03</a>	3	6	30	11	20	110	36	36	6.5	0.121
		<a href="#">3311 13 17 04</a>	4	6	30	11	20	146	72	36	6.5	0.144
		<a href="#">3311 13 17 05</a>	5	6	30	11	20	182	108	36	6.5	0.212
		<a href="#">3311 13 17 06</a>	6	6	30	11	20	218	144	36	6.5	0.265

## 3312 Cross Manifold, Female BSPP and Metric Thread

Treated aluminium

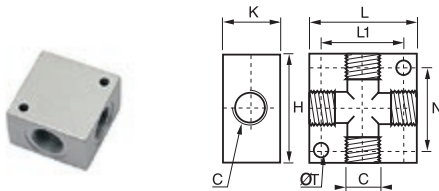

C		H	K	L	L1	N	ØT	Kg
M5x0.8	<a href="#">3312 00 19</a>	20	10	20	12	12	4.5	0.010
G1/8	<a href="#">3312 00 10</a>	30	16	30	23	22	4.5	0.029
G1/4	<a href="#">3312 00 13</a>	40	20	40	30	27	5.5	0.061
G3/8	<a href="#">3312 00 17</a>	50	25	50	38	39	6.5	0.125
G1/2	<a href="#">3312 00 21</a>	50	25	50	38	39	6.5	0.101

## 3313 Double Manifold, Female BSPP Thread

Treated aluminium

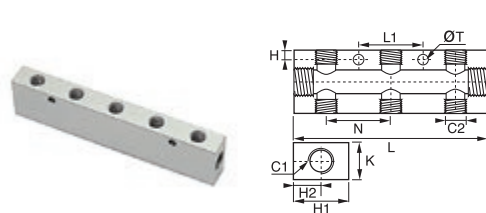

C1	C2		Number of Outlets	H	H1	H2	K	L	L1	N	ØT	Kg
G1/4	G1/8	<a href="#">3313 10 13 02</a>	2x2	4.5	30	15	20	61	50	30	5	0.075
		<a href="#">3313 10 13 03</a>	2x3	4.5	30	15	20	91	30	30	5	0.115
		<a href="#">3313 10 13 04</a>	2x4	4.5	30	15	20	121	60	30	5	0.151
G3/8	G1/4	<a href="#">3313 10 13 05</a>	2x5	4.5	30	15	20	151	90	30	5	0.194
		<a href="#">3313 13 17 02</a>	2x2	6	40	20	20	74	61	36	6.5	0.109
		<a href="#">3313 13 17 03</a>	2x3	6	40	20	20	110	36	36	6.5	0.179
G1/2	G1/4	<a href="#">3313 13 17 04</a>	2x4	6	40	20	20	146	72	36	6.5	0.238
		<a href="#">3313 13 17 05</a>	2x5	6	40	20	20	182	108	36	6.5	0.286
		<a href="#">3313 13 21 03</a>	2x3	6	40	20	28	116	36	36	6.5	0.233
		<a href="#">3313 13 21 04</a>	2x4	6	40	20	28	152	72	36	6.5	0.295
		<a href="#">3313 13 21 05</a>	2x5	6	40	20	28	188	108	36	6.5	0.374

# Anodised Aluminium Manifolds

## 3301 Modular Manifold

Treated aluminium, NBR

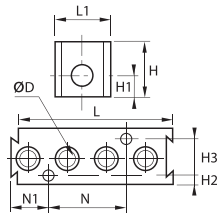

ØD		Number of Outlets	H	H1	H2	H3	L	L1	N	N1	Kg
4	<a href="#">3301 04 00</a>	8	25	10	4.5	16	73.5	25	35	17	0.108
6	<a href="#">3301 06 00</a>	4	25	10	4.5	16	73.5	25	35	17	0.110

Fixing with screw M3x20

## 3301 Manifold, Female BSPP Thread

Treated aluminium, NBR

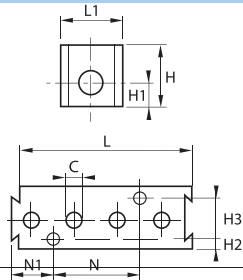

C		Number of Outlets	H	H1	H2	H3	L	L1	N	N1	Kg
G1/8	<a href="#">3301 07 10</a>	4	25	10	4.5	16	73.5	25	35	17	0.097

Fixing with screw M3x20

NPT available on request

## 3302 Single Manifold, Female BSPP Thread

Treated aluminium, NBR

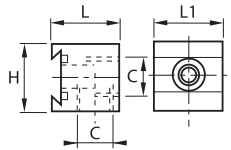

C		H	L	L1	Kg
G1/4	<a href="#">3302 01 13 01</a>	25	24.5	25	0.031

3302 01 13: side entry thread

3302 01 13 01: rear entry thread

NPT available on request

## 3302 Double Manifold, Female BSPP Thread

Treated aluminium, NBR

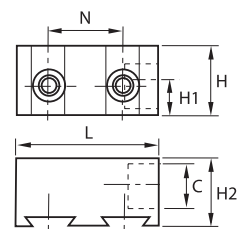

C		H	H1	H2	L	N	Kg
G3/8	<a href="#">3302 02 17</a>	25	12.5	24.5	51	26	0.061

Side entry thread

NPT available on request

## 3302 Triple Manifold, Female BSPP Thread

Treated aluminium, NBR

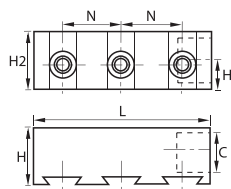

C		H	H1	H2	L	N	Kg
G3/8	<a href="#">3302 03 17</a>	25	12.5	25	77	26	0.087

Lateral supply

NPT available on request

# Anodised Aluminium Manifolds

## 3303 End Plate for Manifold

Treated aluminium

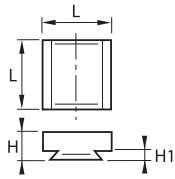

3303 00 01

H	H1	L	Kg
9.5	3.5	25	0.014

## 3303 Angled Fixing Plate

Treated aluminium

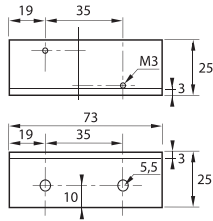

3303 00 02

Kg
0.029

# Brass Plugs

## 0205 Internal Hexagon Head Plug, Male BSPT Thread

Brass

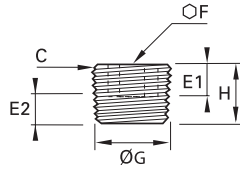

C		E1	E2 min	E2 max	F	G	H	Kg
R1/8	<a href="#">0205 10 00</a>	6	3.1	4.9	5	9.7	8	0.003
R1/4	<a href="#">0205 13 00</a>	8	4.7	7.3	6	13.2	10	0.007
R3/8	<a href="#">0205 17 00</a>	8	5.1	7.7	8	16.7	11	0.013
R1/2	<a href="#">0205 21 00</a>	8	6.4	10	10	21	13	0.026
R3/4	<a href="#">0205 27 00</a>	11	7.7	11.3	14	26.4	17	0.054
R1	<a href="#">0205 34 00</a>	13	8.1	12.7	17	33.2	19	0.094
R1 1/4	<a href="#">0205 42 00</a>	14	10.4	15	22	41.9	22	0.178
R1 1/2	<a href="#">0205 49 00</a>	14	10.4	15	24	47.8	22	0.246
R2	<a href="#">0205 48 00</a>	16	13.6	18.2	30	59.6	25	0.431

For BSPT plug from 1/2" - 1 1/2" inclusive:

Conforms to DIN 906

Thread: EN 10226-1

## 0205 Internal Hexagon Head Plug, Male NPT Thread

Brass

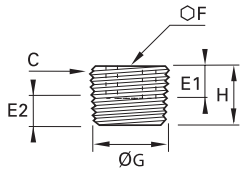

C		E1	E2 min	E2 max	F	G	H	Kg
NPT1/8	<a href="#">0205 11 00</a>	6	3.2	5	5	10.2	8	0.003
NPT1/4	<a href="#">0205 14 00</a>	8	4.4	7.2	6	13.6	10	0.008
NPT3/8	<a href="#">0205 18 00</a>	8	4.7	7.5	8	17	11	0.014
NPT1/2	<a href="#">0205 22 00</a>	8	6.3	9.9	10	21.2	13	0.026
NPT3/4	<a href="#">0205 28 00</a>	11	6.8	10.4	14	26.6	17	0.052
NPT1	<a href="#">0205 35 00</a>	13	8	12.4	17	33.2	19	0.091

## HHP Internal Hexagon Head Plug, Male NPTF Thread, Heavy Series

Brass

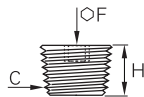

C		F*	H	Kg
NPTF1/4	<a href="#">1/4 HHP-B</a>	1/4	12	0.009

\*Inch dimensions \*\*Max. working pressure: 260 bar

## 219P Hexagon Head Plug, Male NPTF Thread

Brass

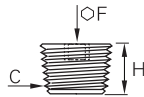

C		F*	H	Kg
NPTF1/8	<a href="#">219P-2</a>	3/16	8	0.004
NPTF1/4	<a href="#">219P-4</a>	1/4	12	0.009
NPTF3/8	<a href="#">219P-6</a>	5/16	12	0.015

\*Inch dimensions

## 0209 Square Head Plug, Male BSPT Thread

Brass

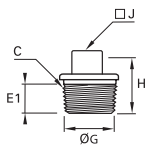

C		E1	E2 min	E2 max	G	H	J	Kg
R1/8	<a href="#">0209 10 00</a>	6	3.1	4.9	9.7	16	6	0.007
R1/4	<a href="#">0209 13 00</a>	8	4.7	7.3	13.2	18	8	0.014
R3/8	<a href="#">0209 17 00</a>	10	5.1	7.7	16.7	20	10	0.025
R1/2	<a href="#">0209 21 00</a>	11	6.4	10	21	22	13	0.047
R3/4	<a href="#">0209 27 00</a>	15	7.7	11.3	26.4	28	17	0.097
R1	<a href="#">0209 34 00</a>	18	8.1	12.7	33.2	32	19	0.169

Conforms to DIN 906

Thread: EN 10226-1

# Brass Plugs

## 0220 Hex Head Plug, Male BSPP and Metric Thread

Brass, technical polymer

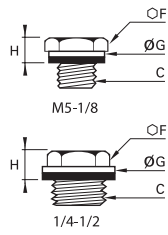

C		F	G	H1	Kg
M5x0.8	<a href="#">0220 19 00</a>	8	8	5	0.002
G1/8	<a href="#">0220 10 00</a>	14	14	7.5	0.011
G1/4	<a href="#">0220 13 00</a>	17	17	7.5	0.019
G3/8	<a href="#">0220 17 00</a>	17	22	8.5	0.024
G1/2	<a href="#">0220 21 00</a>	22	27	10	0.041

Thread with pre-assembled sealing washer

M5: with screwdriver slot for tightening

Maximum allowable working pressure = 20 bar

Part number with suffix 99, maximum allowable working pressure = 250 bar, example: 0220 19 00 99

Conforms to BNA 229 (with the exception of M5 model), BSPP thread, ISO ISO 228-1,

Parallel metric thread, ISO NFE 03-054

## 0200 Hex Head Plug, Male BSPP and Metric Thread

Brass

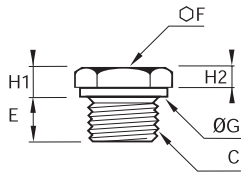

C		E	F	G	H1	H2	Kg
M6x1	<a href="#">0200 52 00</a>	6	10	10	4	3.5	0.004
M8x1.25	<a href="#">0200 57 00</a>	7	13	13	4	3.5	0.007
M10x1	<a href="#">0200 60 00</a>	8	14	14	5	4.5	0.011
M12x1	<a href="#">0200 65 00</a>	9	17	17	5	4.5	0.018
M12x1.25	<a href="#">0200 66 00</a>	9	17	17	5	4.5	0.018
G1/8	<a href="#">0200 10 00</a>	7	14	13.7	5.5	4	0.011
G1/4	<a href="#">0200 13 00</a>	8.5	17	16.7	5.5	4	0.019

# Brass Plugs

## 0201

### Hex Head Plug with Collar, Male BSPP and Metric Thread

Brass

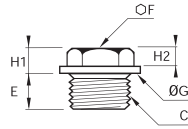

C		E	F	G	H1	H2	Kg
M16x1.5	<a href="#">0201 75 00</a>	10	17	22	6.5	5	0.025
M18x1.5	<a href="#">0201 78 00</a>	10	17	24	7	5	0.027
M20x1.5	<a href="#">0201 80 00</a>	10	17	26	7.5	5	0.031
M22x1.5	<a href="#">0201 82 00</a>	10	22	30	7.5	5	0.044
M24x1.5	<a href="#">0201 83 00</a>	10	22	32	7.5	5	0.048
M24x2	<a href="#">0201 92 00</a>	10	22	32	7.5	5	0.046
M30x2	<a href="#">0201 88 00</a>	11	27	38	8.5	6	0.075
G3/8	<a href="#">0201 17 00</a>	10	17	21.7	6.5	4.5	0.024
G1/2	<a href="#">0201 21 00</a>	10	22	26.7	7.5	5	0.041
G3/4	<a href="#">0201 27 00</a>	11	22	31.7	8.5	6	0.058
G1	<a href="#">0201 34 00</a>	11	27	39.7	8.5	6	0.086
G1 1/4	<a href="#">0201 42 00</a>	12	30	49.7	10	7	0.142

## HP3

### Hexagon Head Plug, Male BSPT Thread

Brass

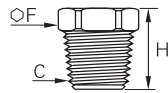

C		F	H	Kg
R1/8	<a href="#">1/8HP3B</a>	10	12	0.007
R1/4	<a href="#">1/4HP3B</a>	14	16	0.018
R3/8	<a href="#">3/8HP3B</a>	17	17	0.029
R1/2	<a href="#">1/2HP3B</a>	22	21	0.059
R3/4	<a href="#">3/4HP3B</a>	27	24	0.110
R1	<a href="#">1HP3B</a>	36	27	0.196

## 218P

### Hexagon Head Plug, Male NPTF Thread, Heavy Series

Brass

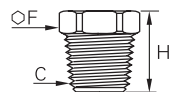

C		F	H	Kg
NPTF1/8	<a href="#">218P-2</a>	7/16	14	0.008
NPTF1/4	<a href="#">218P-4</a>	9/16	19	0.020
NPTF3/8	<a href="#">218P-6</a>	11/16	20	0.033
NPTF1/2	<a href="#">218P-8</a>	7/8	25	0.058

\*Inch dimensions

## 0202

### Internal Hexagon Head Plug with Collar, Male Metric Thread

Brass

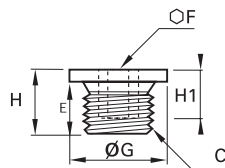

C		E	F	G	H	H1	Kg
M12x1	<a href="#">0202 65 00</a>	9	6	17	11	8	0.009
M12x1.25	<a href="#">0202 66 00</a>	9	6	17	11	8	0.009
M14x1.5	<a href="#">0202 71 00</a>	10	6	19	13	10	0.015
M16x1.5	<a href="#">0202 75 00</a>	10	8	22	13	10	0.019
M18x1.5	<a href="#">0202 78 00</a>	10	10	24	13	10	0.022
M20x1.5	<a href="#">0202 80 00</a>	10	12	26	13	10	0.025
M22x1.5	<a href="#">0202 82 00</a>	10	12	30	13	10	0.034
M27x2	<a href="#">0202 86 00</a>	11	17	35	15	11	0.052
M30x2	<a href="#">0202 88 00</a>	11	19	38	15	11	0.062

Parallel metric threads, ISO standard NFE 03-054



# Nickel-Plated Brass Plugs

## 0936 Internal Hexagon Head Plug, Male BSPT Thread

Nickel-plated brass

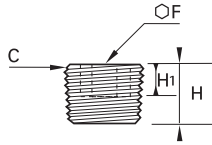

C		F	H	Kg
R1/8	<a href="#">0936 00 10</a>	5	8	0.003
R1/4	<a href="#">0936 00 13</a>	6	10	0.007
R3/8	<a href="#">0936 00 17</a>	8	11	0.013
R1/2	<a href="#">0936 00 21</a>	10	13	0.026

## 0919 Internal Hexagon Head Plug, Male BSPP and Metric Thread

Nickel-plated brass

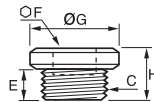

C		E	F	G	H	Kg
M5x0.8	<a href="#">0919 00 19</a>	4	2.5	8	6.5	0.001
G1/8	<a href="#">0919 00 10</a>	6	5	15	9.5	0.007
G1/4	<a href="#">0919 00 13</a>	8	6	18	11.5	0.013
G3/8	<a href="#">0919 00 17</a>	9	8	21	13	0.021
G1/2	<a href="#">0919 00 21</a>	10	10	25	14.5	0.035
G3/4	<a href="#">0919 00 27</a>	11	14	31	15.5	0.049
G1	<a href="#">0919 00 34</a>	13	17	38	17.5	0.072

## 0938 External Hexagon Head Plug, Male BSPP Thread

Nickel-plated brass

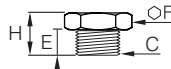

C		E	F	H	Kg
M5x0.8	<a href="#">0938 00 19</a>	4	8	7	0.002
G1/8	<a href="#">0938 00 10</a>	6	14	10	0.007
G1/4	<a href="#">0938 00 13</a>	8	17	12.5	0.014
G3/8	<a href="#">0938 00 17</a>	9	19	13.5	0.020
G1/2	<a href="#">0938 00 21</a>	10	24	15.5	0.031
G3/4	<a href="#">0938 00 27</a>	11	30	16.5	0.050
G1	<a href="#">0938 00 34</a>	13	38	19	0.100

## FN4 Hexagon Head End Plug, Male BSPP Thread

Nickel-plated brass

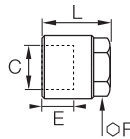

C		E	F	L	Kg
G1/8	<a href="#">1/8FN4BL</a>	7.5	12	11	0.005
G1/4	<a href="#">1/4FN4BL</a>	11	14	19	0.015
G1/2	<a href="#">1/2FN4BL</a>	14	19	22	0.040

# Steel Plugs

## 0206 Internal Hexagon Head Plug, Male BSPT Thread

Steel

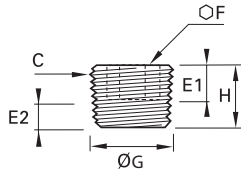

C		E1	E2 <sub>min</sub>	E2 <sub>max</sub>	F	G	H	Kg
R1/8	<a href="#">0206 10 00</a>	6	3.1	4.9	5	9.7	8	0.003
R1/4	<a href="#">0206 13 00</a>	8	4.7	7.3	6	13.2	10	0.007
R3/8	<a href="#">0206 17 00</a>	8	5.1	7.7	8	16.7	11	0.012
R1/2	<a href="#">0206 21 00</a>	8	6.4	10	10	21	13	0.023
R3/4	<a href="#">0206 27 00</a>	11	7.7	11.3	14	26.4	17	0.048
R1	<a href="#">0206 34 00</a>	13	8.1	12.7	17	33.2	19	0.085
R1 1/4	<a href="#">0206 42 00</a>	14	10.4	15	22	41.9	22	0.166
R1 1/2	<a href="#">0206 49 00</a>	14	10.4	15	24	47.8	22	0.222

For BSPT plugs, from 1/2" - 1 1/2" inclusive

Conforms to DIN 906

Thread, conforms to EN 10226-1

## 0206 Internal Hexagon Head Plug, Male NPT Thread

Steel

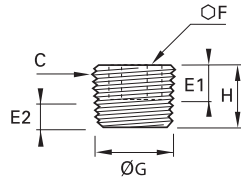

C		E1	E2 <sub>min</sub>	E2 <sub>max</sub>	F	G	H	Kg
NPT1/16	<a href="#">0206 08 00</a>	6	3.8	6.4	4	7.8	7	0.002
NPT1/8	<a href="#">0206 11 00</a>	6	3.2	5	5	10.2	8	0.003
NPT1/4	<a href="#">0206 14 00</a>	8	4.4	7.2	6	13.6	10	0.007
NPT3/8	<a href="#">0206 18 00</a>	8	4.7	7.5	8	17	11	0.012
NPT1/2	<a href="#">0206 22 00</a>	8	6.3	9.9	10	21.2	13	0.023
NPT3/4	<a href="#">0206 28 00</a>	11	6.8	10.4	14	26.6	17	0.048
NPT1	<a href="#">0206 35 00</a>	13	8	12.4	17	33.2	19	0.082

## 0210 Hex Head Plug, Male BSPP and Metric Thread

Steel

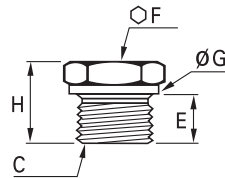

C		E	F	G	H	Kg
M8x1.25	<a href="#">0210 57 00</a>	8	14	12	15	0.011
M10x1	<a href="#">0210 60 00</a>	8	14	14	15	0.013
M12x1.25	<a href="#">0210 66 00</a>	11	17	17	18	0.021
G1/8	<a href="#">0210 10 00</a>	8	14	14	15	0.013
M14x1.25	<a href="#">0210 70 00</a>	11	19	19	20	0.032
G1/4	<a href="#">0210 13 00</a>	12	19	18	21	0.031
G3/8	<a href="#">0210 17 00</a>	12	22	22	21	0.046
G1/2	<a href="#">0210 21 00</a>	14	27	26	24	0.078
G3/4	<a href="#">0210 27 00</a>	16	32	32	27	0.134
G1	<a href="#">0210 34 00</a>	18	41	39	33	0.269
G1 1/4	<a href="#">0210 42 00</a>	20	50	49	35	0.441

Profile of head undercut conforms to DIN 3852-1, form D/E

BSPP threads, ISO 228-1

Parallel metric threads, NFE 03-054

## 0216 Hex Head Plug, Male BSPT Thread

Steel

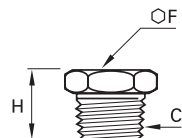

C		F	H	Kg
R1/8	<a href="#">0216 10 00</a>	13	16	0.012
R1/4	<a href="#">0216 13 00</a>	17	19	0.023
R3/8	<a href="#">0216 17 00</a>	19	21	0.038
R1/2	<a href="#">0216 21 00</a>	22	23	0.060

BSPT thread conforms to EN 10226-1





# Steel Plugs

**0216**

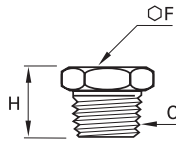
Hex Head Plug, Male NPT Thread

Steel



C		F	H	Kg
NPT1/8	 0216 11 00	13	16	0.012
NPT1/4	 0216 14 00	17	19	0.023
NPT3/8	 0216 18 00	19	21	0.038
NPT1/2	 0216 22 00	22	23	0.060

# Stainless Steel Plugs

## 0285 Internal Hexagon Head Plug, Male BSPT Thread

Stainless steel 316L

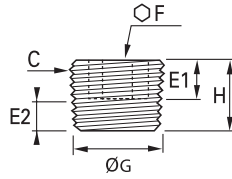

C		E1	E2 min	E2 max	F	G	H	Kg
R1/8	<a href="#">0285 10 00</a>	6	3.1	4.9	5	9.7	8	0.003
R1/4	<a href="#">0285 13 00</a>	8	4.7	7.3	6	13.2	10	0.007
R3/8	<a href="#">0285 17 00</a>	8	5.1	7.7	8	16.7	11	0.013
R1/2	<a href="#">0285 21 00</a>	8	6.4	10	10	21	13	0.024
R3/4	<a href="#">0285 27 00</a>	11	7.7	11.3	14	26.4	17	0.051
R1	<a href="#">0285 34 00</a>	13	8.1	12.7	17	33.2	19	0.089

## 0285 Internal Hexagon Head Plug, Male NPT Thread

Stainless steel 316L

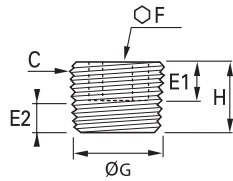

C		E1	E2 min	E2 max	F	G	H	Kg
NPT1/8	<a href="#">0285 11 00</a>	6	3.2	5	5	10.2	8	0.003
NPT1/4	<a href="#">0285 14 00</a>	8	4.4	7.2	6	13.6	10	0.007
NPT3/8	<a href="#">0285 18 00</a>	8	4.7	7.5	8	17	11	0.013
NPT1/2	<a href="#">0285 22 00</a>	8	6.3	9.9	10	21.2	13	0.025

# Sealing Accessories

## 0138

### Copper Washer

Copper

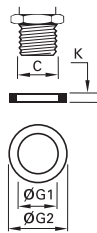

C		G1	G2	K	Kg
M6	<a href="#">0138 06 00</a>	6.3	9	1	0.033
M8	<a href="#">0138 08 00</a>	8.3	11	1	0.001
M12	<a href="#">0138 12 00</a>	12.3	15.5	1.3	0.001
M14	<a href="#">0138 14 00</a>	14.3	18	1.5	0.001
M16	<a href="#">0138 16 00</a>	16.3	20	1.5	0.001
M18	<a href="#">0138 18 00</a>	18.3	22	1.5	0.001
M20	<a href="#">0138 20 00</a>	20.3	24	1.5	0.001
M22	<a href="#">0138 22 00</a>	22.3	27	1.5	0.002
M24	<a href="#">0138 24 00</a>	24.3	29	2	0.003
M26	<a href="#">0138 26 00</a>	26.3	31	2	0.003
M30	<a href="#">0138 30 00</a>	30.3	36	2	0.004
M36	<a href="#">0138 36 00</a>	36.3	42	2	0.005
M39	<a href="#">0138 39 00</a>	39.3	44	2	0.007
M45	<a href="#">0138 45 00</a>	45.3	52	2	0.008
M52	<a href="#">0138 52 00</a>	52.3	60	2	0.009
G1/8	<a href="#">0138 10 00</a>	10.3	13.5	1	0.001
G1/4	<a href="#">0138 13 00</a>	13.5	18	1.3	0.001
G3/8	<a href="#">0138 17 00</a>	17.3	21	1.5	0.001
G1/2	<a href="#">0138 21 00</a>	21.3	26	1.5	0.002
G3/4	<a href="#">0138 27 00</a>	27.3	32	2	0.003
G1	<a href="#">0138 33 00</a>	33.5	39	2	0.005
G1 1/4	<a href="#">0138 42 00</a>	42.5	49	2	0.007
G1 1/2	<a href="#">0138 48 00</a>	48.3	55	2	0.008
G2	<a href="#">0138 60 00</a>	60	68	2.5	0.014

DIN 7603  
ISO 65061

## 0137

### Bonded Seal

Zinc-plated steel with NBR seal

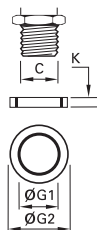

C		G1	G2	K	Kg
M12	<a href="#">0137 12 00</a>	12.7	19	1.5	0.001
M14	<a href="#">0137 14 00</a>	14.7	21	1.5	0.001
M16	<a href="#">0137 16 00</a>	16.7	23	1.5	0.002
M18	<a href="#">0137 18 00</a>	18.7	27	2	0.004
M20	<a href="#">0137 20 00</a>	20.7	29	2	0.004
M22	<a href="#">0137 22 00</a>	22.7	31	2	0.005
M24	<a href="#">0137 24 00</a>	24.7	33	2	0.005
M30	<a href="#">0137 30 00</a>	30.7	39	2	0.071
M39	<a href="#">0137 39 00</a>	40	51	2.5	0.012
M45	<a href="#">0137 45 00</a>	46	57	2.5	0.014
G1/8	<a href="#">0137 10 00</a>	10.7	17	1.5	0.001
G1/4	<a href="#">0137 13 00</a>	13.7	20.6	2.1	0.002
G3/8	<a href="#">0137 17 00</a>	17.4	23.7	1.5	0.002
G1/2	<a href="#">0137 21 00</a>	21.5	28.6	2.5	0.004
G3/4	<a href="#">0137 27 00</a>	27	35.3	2	0.007
G1	<a href="#">0137 33 00</a>	33.7	42	2	0.007
G1 1/4	<a href="#">0137 42 00</a>	43	54	2.5	0.013
G1 1/2	<a href="#">0137 48 00</a>	49	60	2.5	0.015
G2	<a href="#">0137 60 00</a>	60.7	73	3	0.027

Note: to use these bonded seals successfully it is necessary to spot face around the female thread to provide a sealing "land".

The diameter should be 0.3 mm to 0.5 mm greater than the external diameter of the seal.

The surface finish of the thread should not exceed 12 µ.

# Sealing Accessories

## 0605 Fluoropolymer Tape

FKM



Kg

### 0605 12 12

0.012

Can be used for temperatures from - 250°C to +260°C.

Chemically inert and resistant to gases, acids, solvents, hydrocarbons, oils, alkalines, steam etc.

Non-toxic, waterproof, self-lubricating.

In accordance with CFR21.

Can be used on all materials.

Used to facilitate the preparation of leak-free threaded joints.

Supplied on a reel, length = 12 m, width = 12.7 mm, thickness 0.08 mm.

## 0602 Captive Sealing Washer

Technical polymer

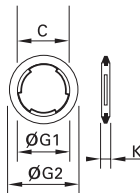

C



G1

G2

K

Kg

M5x0.8	<a href="#">0602 29 93 15</a>	5.2	7.8	1.5	0.001
G1/8	<a href="#">0602 23 10 20</a>	10.3	14	2	0.001
G1/4	<a href="#">0602 23 11 20</a>	13.7	17.5	2	0.001
G3/8	<a href="#">0602 23 12 20</a>	17.2	21	2	0.001
G1/2	<a href="#">0602 23 13 20</a>	21.5	25.5	2.5	0.002
G3/4	<a href="#">0602 27 32 20</a>	27	32	2.5	0.001
G1	<a href="#">0602 30 60 20</a>	33.8	39	3	0.001

Maximum allowable working pressure: 20 bar

## 0139 Bi-Material Captive Sealing Washer

Zinc-plated steel with NBR seal

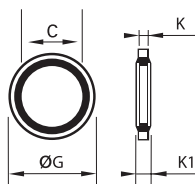

C



G

K

K1

Kg

G1/8	<a href="#">0139 10 00</a>	14	1	1.7	0.001
G1/4	<a href="#">0139 13 00</a>	17	1	1.7	0.001
G3/8	<a href="#">0139 17 00</a>	22	1.2	2.1	0.001
G1/2	<a href="#">0139 21 00</a>	26	1.6	2.5	0.002
G3/4	<a href="#">0139 27 00</a>	32	1.5	2.5	0.003
G1	<a href="#">0139 34 00</a>	39.6	1.7	2.6	0.003

Maximum allowable working pressure: 250 bar

Technical characteristics of captive seals **0602**

Tightening torque



	M5x0.8	G1/8	G1/4	G3/8	G1/2	G3/4	G1
Min. Torque in daN.m	0.06	0.08	0.3	0.5	1	1.2	1.9
Max. Torque daN.m	0.16	0.8	1.2	3	3.5	6	9

# Tube Supports

## 0127

### Brass Tube Support for Polymer Tubing

Brass

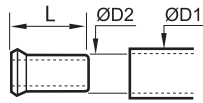

ØD1	ØD2		L	Kg
4	2	<a href="#">0127 04 00</a>	11	0.001
	2.7	<a href="#">0127 04 27</a>	11	0.001
5	3	<a href="#">0127 05 03</a>	11	0.001
	3.3	<a href="#">0127 05 00</a>	11.5	0.009
6	4	<a href="#">0127 06 00</a>	11.5	0.001
	5.5	<a href="#">0127 08 55</a>	14	0.001
8	6	<a href="#">0127 08 00</a>	14	0.001
	7	<a href="#">0127 10 07</a>	18	0.001
10	7.5	<a href="#">0127 10 75</a>	18	0.001
	8	<a href="#">0127 10 00</a>	18	0.002
12	8	<a href="#">0127 12 08</a>	18	0.002
	9	<a href="#">0127 12 09</a>	18	0.001
14	10	<a href="#">0127 12 00</a>	18	0.001
	11	<a href="#">0127 14 11</a>	18	0.002
15	12	<a href="#">0127 14 00</a>	18	0.002
	12	<a href="#">0127 15 12</a>	18	0.002
16	13	<a href="#">0127 16 13</a>	18	0.003
18	14	<a href="#">0127 18 14</a>	19.5	0.003
20	15	<a href="#">0127 20 15</a>	20.5	0.003
22	16	<a href="#">0127 22 16</a>	21	0.004
25	19	<a href="#">0127 25 19</a>	25	0.007

This tube support guarantees good gripping, at high temperatures and pressures, by preventing collapsing of the tube.

## 1827

### Stainless Steel Tube Support for Fluoropolymer Tubing

Stainless steel 316L

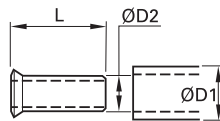

ØD1	ØD2		L	Kg
6	4	<a href="#">1827 06 00</a>	11.5	0.001
8	6	<a href="#">1827 08 00</a>	14	0.001
10	8	<a href="#">1827 10 00</a>	18	0.001
12	9	<a href="#">1827 12 09</a>	18	0.001
	10	<a href="#">1827 12 00</a>	18	0.001
16	14	<a href="#">1827 16 00</a>	18	0.002

This tube support is necessary when using fluoropolymer tubing at all temperatures compatible with the fitting/tubing assembly.









## Together, we can connect you to the best in technology

Inventor of the push-in fitting with more than 40 years of experience, Parker Legris has the know-how necessary for providing fluid connectors adapted to a wide variety of environments, such as production automation, packaging, transport, food process and the medical industry. Our wide selection of fittings, tubing, ball valves and accessories, along with our capacity to develop specific products, allow our customers to find the very best connector solution. Parker Legris, the right partner to accompany you in product development.

aerospace  
climate control  
electromechanical  
filtration  
fluid & gas handling  
hydraulics  
pneumatics  
process control  
sealing & shielding



ENGINEERING YOUR SUCCESS.

[www.parkerlegris.com](http://www.parkerlegris.com)

# Index

Part Number	Page	0222	1-37	0904	9-18	3082	2-8	3303	9-29	4991	6-23
		0285	9-36	0905	9-18	3086	2-8	3304	1-21	4992	6-23
0101	5-10, 11	0400	6-10	0906	9-18	3088	2-9	3306	1-21	6101	1-109
0102	5-16	0401	6-10	0907	9-19	3089	2-8	3310	1-21, 9-27	6104	1-110
0103	5-13	0402	6-10	0908	9-17	3091	1-35	3311	9-27	6105	1-109
0104	5-17	0411	6-10	0909	9-17	3100	1-16, 2-8	3312	9-27	6106	1-110
0105	5-9	0414	6-10	0910	9-15	3101	1-8	3313	9-27	6114	1-109
0106	5-15	0432	6-15	0911	9-15	3102	1-17	3320	1-31	6179	1-109
0107	5-17	0436	6-15	0912	9-14	3103	1-14	3321	1-31	6270	1-75
0108	5-13	0437	6-15	0913	9-14	3104	1-18	3329	1-31	6271	1-77
0109	5-12	0438	6-15	0914	9-15	3106	1-17	3379	1-32	6273	1-75
0110	5-22	0439	6-15	0915	9-15	3107	1-19	3381	1-32	6274	1-79
0111	5-21	0446	6-11	0916	9-16	3108	1-14	3391	1-35	6276	1-81
0112	5-28	0448	6-12	0917	9-16	3109	1-10, 11	3524	1-29	6300	1-50, 2-10
0113	5-16	0449	6-13	0919	9-33	3110	1-37, 60	3527	1-29	6302	1-54
0114	5-11	0452	6-12	0920	9-19	3112	1-16	3528	1-29	6304	1-55
0116	5-16	0461	6-14	0921	9-14	3113	1-13	3529	1-29	6306	1-54
0117	9-8	0462	6-14	0922	9-14	3114	1-9	3538	1-28	6307	1-56
0118	5-14	0465	6-29	0923	9-15	3116	1-20	3539	1-28	6315	1-48, 49
0119	5-15	0469	6-13	0924	9-16	3118	1-27	3549	1-28	6316	1-56
0120	5-28	0471	6-11	0927	9-16	3119	1-27	3600	1-98, 2-13	6322	1-59
0121	9-11	0472	6-11	0928	9-16	3120	1-24	3601	1-97	6325	1-49
0122	5-26	0482	6-12	0929	9-12	3121	1-9	3602	1-102	6326	1-58, 59
0123	9-12	0483	6-12	0931	9-20	3122	1-25	3603	1-100	6331	1-63
0124	5-21	0489	6-13	0932	9-17	3124	1-27	3604	1-102	6332	1-63
0125	5-27	0490	6-17	0933	9-18	3126	1-25, 93	3606	1-102	6333	1-63
0126	5-27	0491	6-17	0934	9-21	3129	1-12	3608	1-100	6336	1-63
0127	3-47, 5-30, 9-39	0492	6-17	0935	9-21	3130	1-37, 60, 81	3609	1-99	6340	1-55
0132	5-25	0494	6-18	0936	9-33	3131	1-10	3610	1-105	6351	1-59
0134	5-25	0496	6-18	0938	9-33	3132	1-16	3614	1-98	6352	1-49
0135	9-26	0497	6-18	1802	5-36	3133	1-13	3616	1-103	6353	1-49
0136	9-13	0501	6-39	1804	5-36	3136	1-20	3618	1-101	6355	1-53
0137	9-37	0502	6-39	1805	5-34	3139	1-20	3620	1-104	6366	1-58
0138	1-110, 9-37	0510	6-39	1806	5-36	3140	1-18	3621	1-98	6368	1-58
0139	9-38	0531	6-39	1809	5-35	3142	1-23	3622	1-104	6380	1-57
0142	5-17	0532	6-39	1810	5-39	3143	1-23	3626	1-105	6382	1-57
0143	9-7	0562	6-40	1814	5-34	3144	1-21	3629	1-99	6383	1-57
0144	9-7	0563	6-40	1816	5-36	3146	1-20	3631	1-98	6388	1-57, 58
0145	9-7	0591	6-41	1817	9-22	3148	1-15	3636	1-103	6401	6-11
0152	9-7	0602	9-38	1820	5-35	3149	1-27	3639	1-103	6402	6-11
0155	9-8	0605	1-60, 105, 123, 9-38	1821	9-24, 25	3150	8-23	3666	1-104	6503	1-53
0158	9-8	0622	7-15	1822	5-39	3151	1-25, 77	3667	1-104	6505	1-48
0163	9-10	0623	7-15	1823	9-25	3158	1-15	3668	1-104	6508	1-52, 53
0164	5-47, 8-31, 9-9	0627	6-40	1824	5-39	3159	1-35	3669	1-100	6509	1-51, 52
0165	5-26	0630	6-40	1827	3-47, 5-39, 9-39	3160	1-35	3675	1-97	6521	1-50
0166	5-20	0651	7-9	1843	9-22	3166	1-24	3681	1-97	6579	1-51
0167	8-31, 9-9	0652	7-8	1844	9-22	3168	1-24	3693	1-101	6901	1-68
0168	9-9	0653	7-8, 7-10	1845	9-22	3169	1-13	3698	1-100	6903	1-70
0169	9-10	0654	7-7, 7-10	1855	9-23	3175	1-7, 8	3699	1-99	6905	1-68
0171	8-22, 23	0655	7-8	1861	9-24	3180	1-22	3800	1-123	6908	1-69
0172	8-24, 25	0656	7-9, 7-10	1862	9-23	3181	1-8	3803	1-119	6909	1-69
0178	1-37	0657	7-9	1863	9-24	3182	1-22	3805	1-115	6911	1-65
0180	8-23	0658	7-9	1864	9-23	3183	1-23	3808	1-120	6953	1-67
0181	8-22, 23	0659	7-7, 7-10	1866	5-39	3184	1-22	3809	1-117	6958	1-66
0183	8-22	0669	4-59	1867	9-23	3188	1-23	3821	1-116	6959	1-65
0184	8-22	0670	4-63	1870	9-23	3189	1-35	3826	1-123	6973	1-67
0185	8-24	0671	4-64	1871	9-22	3192	1-12	3889	1-118	6975	1-65
0186	8-24	0672	4-64	1872	9-24	3193	1-15	4020	6-35	6978	1-66
0187	8-24	0673	4-63	1873	9-24	3198	1-14	4021	6-35	6979	1-66
0189	8-24	0674	4-63	2203	8-27	3199	1-11	4022	6-35	6993	1-70
0191	9-20	0675	4-63	2270	8-27	3202	1-43	4023	6-35	6998	1-69
0192	9-20	0676	4-63	2272	8-25, 29	3204	1-43	4024	6-35	6999	1-68
0195	8-26	0677	4-64	2292	8-27	3206	1-43	4298	6-49	7000	4-16, 55, 6-33
0196	8-26	0681	8-31	2293	8-26	3218	1-42	4299	6-49	7010	4-10
0199	5-12	0682	4-64	2294	8-25, 29	3226	1-43	4402	6-31	7011	4-10
0200	9-31	0683	4-64	2295	8-26, 29	3229	1-41	4602	6-43	7012	4-10
0201	9-32	0691	8-31	2296	8-26	3266	1-43	4810	6-29	7020	4-17
0202	9-32	0694	3-39, 46	2297	8-25, 29	3281	1-41	4812	6-29	7030	4-18
0205	9-30	0695	3-39, 46	2299	7-15, 8-28	3293	1-41	4832	6-29	7031	4-18
0206	9-34	0697	3-47	2398	8-27	3298	1-41	4890	4-47	7040	4-14
0209	9-30	0900	9-19	2511	8-25	3299	1-41	4891	4-47	7041	4-14
0210	9-34	0901	9-19	3000	1-37, 123	3300	1-31	4892	4-47	7045	4-14
0216	9-34, 35	0902	9-20	3018	1-27	3301	9-28	4895	4-47	7060	4-11
0220	5-27, 31	0903	9-17	3081	2-9	3302	9-28	4902	6-23	7061	4-11

# Index

7062	4-12	7995	4-41	1100U..R	3-20	9084A	8-16	KRRS3	9-17
7065	4-11	7996	4-41	1100U..A	3-23	9086A	8-16	MM08BKT	1-90
7066	4-11	0101..39	5-10	1100U..K	3-25	9086E	8-14	MMS8UB	1-90
7067	4-12	0110..40	5-22	1100U..V	3-25	9086U	8-11	MRO434	9-7
7100	4-20	0110..60	5-22	1100Y	3-27	9087A	8-16	MRO8UB	1-90
7101	4-20	0110..70	5-22	1420U	3-33	9087E	8-14	P8UNBL	1-93
7110	4-20	0118..39	5-14	1441U..R	3-38	9087U	8-11	PPRC8UM	1-92
7111	4-21	0119..39	5-15	1442U..E	3-41	9094A	8-17	PPRF8UM	1-92
7130	4-19	0124..40	5-21	1442U..R	3-38	9094E	8-14	PPRV8UM	1-92
7140	4-19	0128..39	5-29	1445U..E	3-41	9094U	8-12	R3BPL	5-45
7160	4-19	0133..39	5-25	1445U..R	3-38	9401A	8-15	R68UNPMK	1-85
7170	4-21	0151..39	5-29	1447U..E	3-41	9401E	8-13	S3BPL	5-45
7180	4-20	0168..39	5-29	1447U..R	3-38	9401U	8-10	S8UNPMB	1-88
7190	4-21	0220..39	5-27	1460U	3-37	9405A	8-15	S8UNPMBPPAM	1-88
7300	4-53	0491..64	6-17	1461U	3-37	9405U	8-10	T2ENPMB	1-89
7316	4-55	0492..64	6-17	1462U	3-37	9410A	8-15	TLT	2-13
7318	4-55	0631..01	7-17	1470P	3-35	9410E	8-13	V68UNPMK	1-85
7416	4-55	0631..02	7-18	1470U	3-37	9410U	8-10	V8UNPMB	1-88
7471	4-55	0631..03	7-18	1471P	3-35	9414A	8-15	VDPF8UM	1-93
7630	4-18	0631..04	7-18	1471U	3-37	9414E	8-13	WBPL	5-47
7631	4-18	0631..05	7-18	1472P	3-35	9414U	8-10	WBPL-1	5-47
7640	4-15	0631..06	7-19	1472U	3-37	9416A	8-16	WEONPMB	1-87
7645	4-15	0631..07	7-19	2003U	3-19	9416E	8-13	WG8F8UB	1-92
7649	4-15	0631..08	7-19	2003U..R	3-20	9416U	8-11	WGG88B	1-92
7660	4-13	0631..09	7-17	2005P	3-11	9421A	8-15	WLNB	1-93
7662	4-14	0631..23	7-17	2005U	3-19	9421E	8-13	WNPMB	1-89
7665	4-13	0631..30	7-17	2005U..R	3-20	9421U	8-10		
7668	4-13	0690 01	7-11	2010P	3-11	9440A	8-16		
7669	4-13	0690 02	7-11	2010U	3-19	9440E	8-14		
7680	4-20	0690 03	7-11	2010U..R	3-20	9440U	8-11		
7762	4-21	0690 04	7-11	207ACBH	9-8	BPLM	5-47		
7770	4-16	0690 05	7-11	207P	9-9	BPLM-M	5-47		
7771	4-16	0690 06	7-12	209P	9-10	BVG4-L	6-21		
7772	4-16	0690 06 01	7-12	216P	9-12	BVG4-LOCK	6-24		
7776	4-16	0690 07	7-12	218P	9-32	BVG4P-LOCK	6-24		
7800	4-59	0690 08	7-12	219P	9-30	BVGT4-C	6-23		
7801	4-59	0690 09	7-12	222P	9-11	BVGT4-L	6-21		
7802	4-59	0690 10	7-13	3000 70 00	1-105	C3BPL	5-44		
7810	4-23	0690 11	7-13	3000 71 00	3-46	C3BPL-1	5-44		
7812	4-23	1005T	3-29	3000 71 11	3-46	C4BPL	5-44		
7818	4-51	1010P..M	3-33	3151..03	1-77	C68UNPMK	1-85		
7820	4-23	1010T..A	3-31	3800/3900	1-117, 2-13	C8BPL-1	5-44		
7822	4-23	1010T..P	3-31	3801/3901	1-115	C8UNPMB	1-88		
7828	4-51	1015Y..F	3-27	3802/3902	1-121	CLIP	1-37, 3-47		
7860	4-49	1025L	3-12	3803/3903	1-119	COR4BPL	5-45		
7861	4-49	1025P	3-11	3804/3904	1-121	D8C8UB	1-90		
7870	4-49	1025P..V	3-17	3805/3905	1-115	D8V8UB	1-90		
7871	4-49	1025T	3-29	3806/3906	1-121	DD44BKTL	9-14		
7880	4-37	1025U	3-19	3808/3908	1-119	F2NPMB	1-87		
7881	4-37	1025U..A	3-23	3809/3909	1-117	F3BPL	5-43		
7883	4-37	1025U..K	3-25	3816/3916	1-122	F3BPL-1	5-43		
7885	4-37	1025U..R	3-20	3821/3921	1-116	F4BPL	5-43		
7886	4-37	1025U..V	3-25	3831/3931	1-116	F8BPL	5-43		
7892	4-39	1025V	3-43	3866/3966	1-123	F8BPL-1	5-43		
7894	4-39	1025V..C	3-43	3879/3979	1-118	F8UGB	1-91		
7899	4-61	1030Y..F	3-27	3889/3989	1-118	F8UG4B	1-91		
7910	6-33	1040H	3-45	3893/3993	1-119	F8UG8B	1-91		
7911	6-33	1050P..M	3-33	3898/3998	1-120	F8UHA8UB	1-91		
7913	6-33	1050T..A	3-31	3899/3999	1-117	F8UNPMB	1-87		
7914	6-33	1050T..P	3-31	4202..20	6-48	FF44	9-11		
7921	4-57	1050V	3-43	4202..30	6-48	FG43	9-10		
7926	4-57	1050V..C	3-43	4212..20	6-48	FN4	9-33		
7930	4-43	1075Y..F	3-27	4212..30	6-48	FTL	2-13		
7931	4-43	1080H	3-45	4222..20	6-49	GG-B	9-9		
7932	4-43	1096Y..F	3-27	4222..30	6-49	HBPL	5-46		
7960	4-57	1098Y..F	3-27	6000 71 00	3-17, 25, 46	HBPL-1	5-46		
7961	4-57	1099Y..F	3-27	6270..03	1-75	HHP	9-30		
7970	4-61	1100H	3-45	6271..03	1-77	HNPMB	1-89		
7971	4-61	1100P	3-11	6273..03	1-75	HP3	9-32		
7984	4-41	1100P..R	3-15	9071U	8-31	JBPL	5-46		
7985	4-41	1100P..V	3-17	9080A	8-17	JBPL-1	5-46		
7992	4-45	1100T..P	3-31	9080E	8-14	JNPMB	1-89		
7994	4-41	1100U	3-19	9080U	8-12	JNPMK	1-85		



# Parker Safety Guide

## User Responsibility

### Selection and Use of Fittings, Function Fittings, Tubing and Related Products

**WARNING:** Failure or improper selection or improper use of fittings, function fittings, tubing or related products ("Products") can cause death, personal injury and property damage.

Possible consequences of failure or improper selection or improper use of these Products include but are not limited to:

- Fittings thrown off at high speed.
- High velocity fluid discharge.
- Explosion or burning of the conveyed fluid.
- Electrocutation from high voltage electric power lines.
- Contact with suddenly moving or falling objects that are controlled by the conveyed fluid.
- Injections by high pressure fluid discharge.
- Dangerously whipping tubing.
- Contact with conveyed fluids that may be hot, cold, toxic or otherwise injurious.
- Sparking or explosion caused by static electricity build-up or other sources of electricity.
- Sparking or explosion while spraying paint or flammable liquids.
- Injuries resulting from inhalation, ingestion or exposure to fluids.
- Dynamic applications with strong oscillation.

The user, through his own analysis and testing, is solely responsible for making the final selection of the system and components and assuring that all performance, endurance, maintenance, safety and warning requirements of the application are met. The user must analyze all aspects of the application, follow applicable industry standards, and follow the information concerning the product in the current product catalog and in any other materials provided from Parker or its subsidiaries or authorized distributors.

To the extent that Parker or its subsidiaries or authorized distributors provide component or system options based upon data or specifications provided by the user, the user is responsible for determining that such data and specifications are suitable and sufficient for all applications and reasonably foreseeable uses of the components or systems.

**Parker Legris has a continuous product development policy and therefore reserves the right to modify products shown in this catalogue. Please treat all dimensions and photos therefore as indicative.**

### Photography Credits:

Jochen Detscher

### Graphic Design:

Sylvain Fromentin



# Parker's Motion & Control Technologies

At Parker, we're guided by a relentless drive to help our customers become more productive and achieve higher levels of profitability by engineering the best systems for their requirements. It means looking at customer applications from many angles to find new ways to create value. Whatever the motion and control technology need, Parker has the experience, breadth of product and global reach to consistently deliver. No company knows more about motion and control technology than Parker. For further info call 00800 27 27 5374



## Aerospace

### Key Markets

Aftermarket services  
Commercial transports  
Engines  
General & business aviation  
Helicopters  
Launch vehicles  
Military aircraft  
Missiles  
Power generation  
Regional transports  
Unmanned aerial vehicles

### Key Products

Control systems & actuation products  
Engine systems & components  
Fluid conveyance systems & components  
Fluid metering, delivery & atomization devices  
Fuel systems & components  
Fuel tank inerting systems  
Hydraulic systems & components  
Thermal management  
Wheels & brakes



## Climate Control

### Key Markets

Agriculture  
Air conditioning  
Construction Machinery  
Food & beverage  
Industrial machinery  
Life sciences  
Oil & gas  
Precision cooling  
Process  
Refrigeration  
Transportation

### Key Products

Accumulators  
Advanced actuators  
CO<sub>2</sub> controls  
Electronic controllers  
Filter driers  
Hand shut-off valves  
Heat exchangers  
Hose & fittings  
Pressure regulating valves  
Refrigerant distributors  
Safety relief valves  
Smart pumps  
Solenoid valves  
Thermostatic expansion valves



## Electromechanical

### Key Markets

Aerospace  
Factory automation  
Life science & medical  
Machine tools  
Packaging machinery  
Paper machinery  
Plastics machinery & converting  
Primary metals  
Semiconductor & electronics  
Textile  
Wire & cable

### Key Products

AC/DC drives & systems  
Electric actuators, gantry robots & slides  
Electrohydraulic actuation systems  
Electromechanical actuation systems  
Human machine interface  
Linear motors  
Stepper motors, servo motors, drives & controls  
Structural extrusions



## Filtration

### Key Markets

Aerospace  
Food & beverage  
Industrial plant & equipment  
Life sciences  
Marine  
Mobile equipment  
Oil & gas  
Power generation & renewable energy  
Process  
Transportation  
Water Purification

### Key Products

Analytical gas generators  
Compressed air filters & dryers  
Engine air, coolant, fuel & oil filtration systems  
Fluid condition monitoring systems  
Hydraulic & lubrication filters  
Hydrogen, nitrogen & zero air generators  
Instrumentation filters  
Membrane & fiber filters  
Microfiltration  
Sterile air filtration  
Water desalination & purification filters & systems



## Fluid & Gas Handling

### Key Markets

Aerial lift  
Agriculture  
Bulk chemical handling  
Construction machinery  
Food & beverage  
Fuel & gas delivery  
Industrial machinery  
Life sciences  
Marine  
Mining  
Mobile  
Oil & gas  
Renewable energy  
Transportation

### Key Products

Check valves  
Connectors for low pressure fluid conveyance  
Deep sea umbilicals  
Diagnostic equipment  
Hose couplings  
Industrial hose  
Mooring systems & power cables  
PTFE hose & tubing  
Quick couplings  
Rubber & thermoplastic hose  
Tube fittings & adapters  
Tubing & plastic fittings



## Hydraulics

### Key Markets

Aerial lift  
Agriculture  
Alternative energy  
Construction machinery  
Forestry  
Industrial machinery  
Machine tools  
Marine  
Material handling  
Mining  
Oil & gas  
Power generation  
Refuse vehicles  
Renewable energy  
Truck hydraulics  
Turf equipment

### Key Products

Accumulators  
Cartridge valves  
Electrohydraulic actuators  
Human machine interfaces  
Hybrid drives  
Hydraulic cylinders  
Hydraulic motors & pumps  
Hydraulic systems  
Hydraulic valves & controls  
Hydrostatic steering  
Integrated hydraulic circuits  
Power take-offs  
Power units  
Rotary actuators  
Sensors



## Pneumatics

### Key Markets

Aerospace  
Conveyor & material handling  
Factory automation  
Life science & medical  
Machine tools  
Packaging machinery  
Transportation & automotive

### Key Products

Air preparation  
Brass fittings & valves  
Manifolds  
Pneumatic accessories  
Pneumatic actuators & grippers  
Pneumatic valves & controls  
Quick disconnects  
Rotary actuators  
Rubber & thermoplastic hose & couplings  
Structural extrusions  
Thermoplastic tubing & fittings  
Vacuum generators, cups & sensors



## Process Control

### Key Markets

Alternative fuels  
Biopharmaceuticals  
Chemical & refining  
Food & beverage  
Marine & shipbuilding  
Medical & dental  
Microelectronics  
Nuclear Power  
Offshore oil exploration  
Oil & gas  
Pharmaceuticals  
Power generation  
Pulp & paper  
Steel  
Water/wastewater

### Key Products

Analytical Instruments  
Analytical sample conditioning products & systems  
Chemical injection fittings & valves  
Fluoropolymer chemical delivery fittings, valves & pumps  
High purity gas delivery fittings, valves, regulators & digital flow controllers  
Industrial mass flow meters/controllers  
Permanent no-weld tube fittings  
Precision industrial regulators & flow controllers  
Process control double block & bleeds  
Process control fittings, valves, regulators & manifold valves



## Sealing & Shielding

### Key Markets

Aerospace  
Chemical processing  
Consumer  
Fluid power  
General industrial  
Information technology  
Life sciences  
Microelectronics  
Military  
Oil & gas  
Power generation  
Renewable energy  
Telecommunications  
Transportation

### Key Products

Dynamic seals  
Elastomeric o-rings  
Electro-medical instrument design & assembly  
EMI shielding  
Extruded & precision-cut, fabricated elastomeric seals  
High temperature metal seals  
Homogeneous & inserted elastomeric shapes  
Medical device fabrication & assembly  
Metal & plastic retained composite seals  
Shielded optical windows  
Silicone tubing & extrusions  
Thermal management  
Vibration dampening



ENGINEERING YOUR SUCCESS.



# Parker Worldwide

## Europe, Middle East, Africa

**AE – United Arab Emirates,** Dubai  
Tel: +971 4 8127100  
parker.me@parker.com

**AT – Austria,** Wiener Neustadt  
Tel: +43 (0)2622 23501-0  
parker.austria@parker.com

**AT – Eastern Europe,** Wiener Neustadt  
Tel: +43 (0)2622 23501 900  
parker.easteurope@parker.com

**AZ – Azerbaijan,** Baku  
Tel: +994 50 2233 458  
parker.azerbaijan@parker.com

**BE/LU – Belgium,** Nivelles  
Tel: +32 (0)67 280 900  
parker.belgium@parker.com

**BG – Bulgaria,** Sofia  
Tel: +359 2 980 1344  
parker.bulgaria@parker.com

**BY – Belarus,** Minsk  
Tel: +48 (0)22 573 24 00  
parker.poland@parker.com

**CH – Switzerland,** Etoy  
Tel: +41 (0)21 821 87 00  
parker.switzerland@parker.com

**CZ – Czech Republic,** Klecany  
Tel: +420 284 083 111  
parker.czechrepublic@parker.com

**DE – Germany,** Kaarst  
Tel: +49 (0)2131 4016 0  
parker.germany@parker.com

**DK – Denmark,** Ballerup  
Tel: +45 43 56 04 00  
parker.denmark@parker.com

**ES – Spain,** Madrid  
Tel: +34 902 330 001  
parker.spain@parker.com

**FI – Finland,** Vantaa  
Tel: +358 (0)20 753 2500  
parker.finland@parker.com

**FR – France,** Contamine s/Arve  
Tel: +33 (0)4 50 25 80 25  
parker.france@parker.com

**GR – Greece,** Athens  
Tel: +30 210 933 6450  
parker.greece@parker.com

**HU – Hungary,** Budaörs  
Tel: +36 23 885 470  
parker.hungary@parker.com

**IE – Ireland,** Dublin  
Tel: +353 (0)1 466 6370  
parker.ireland@parker.com

**IT – Italy,** Corsico (MI)  
Tel: +39 02 45 19 21  
parker.italy@parker.com

**KZ – Kazakhstan,** Almaty  
Tel: +7 7273 561 000  
parker.easteurope@parker.com

**NL – The Netherlands,** Oldenzaal  
Tel: +31 (0)541 585 000  
parker.nl@parker.com

**NO – Norway,** Asker  
Tel: +47 66 75 34 00  
parker.norway@parker.com

**PL – Poland,** Warsaw  
Tel: +48 (0)22 573 24 00  
parker.poland@parker.com

**PT – Portugal,** Leca da Palmeira  
Tel: +351 22 999 7360  
parker.portugal@parker.com

**RO – Romania,** Bucharest  
Tel: +40 21 252 1382  
parker.romania@parker.com

**RU – Russia,** Moscow  
Tel: +7 495 645-2156  
parker.russia@parker.com

**SE – Sweden,** Spånga  
Tel: +46 (0)8 59 79 50 00  
parker.sweden@parker.com

**SK – Slovakia,** Banská Bystrica  
Tel: +421 484 162 252  
parker.slovakia@parker.com

**SL – Slovenia,** Novo Mesto  
Tel: +386 7 337 6650  
parker.slovenia@parker.com

**TR – Turkey,** Istanbul  
Tel: +90 216 4997081  
parker.turkey@parker.com

**UA – Ukraine,** Kiev  
Tel: +380 44 494 2731  
parker.ukraine@parker.com

**UK – United Kingdom,** Warwick  
Tel: +44 (0)1926 317 878  
parker.uk@parker.com

**ZA – South Africa,** Kempton Park  
Tel: +27 (0)11 961 0700  
parker.southafrica@parker.com

## North America

**CA – Canada,** Milton, Ontario  
Tel: +1 905 693 3000

**US – USA,** Cleveland  
Tel: +1 216 896 3000

## Asia Pacific

**AU – Australia,** Castle Hill  
Tel: +61 (0)2-9634 7777

**CN – China,** Shanghai  
Tel: +86 21 2899 5000

**HK – Hong Kong**  
Tel: +852 2428 8008

**IN – India,** Gurgaon  
Tel: +91 124 459 0600  
legris.india@parker.com

**JP – Japan,** Tokyo  
Tel: +81 (0)3 6408 3901

**KR – South Korea,** Seoul  
Tel: +82 2 559 0400

**MY – Malaysia,** Shah Alam  
Tel: +60 3 7849 0800

**NZ – New Zealand,** Mt Wellington  
Tel: +64 9 574 1744

**SG – Singapore**  
Tel: +65 6887 6300

**TH – Thailand,** Bangkok  
Tel: +662 186 7000

**TW – Taiwan,** Taipei  
Tel: +886 2 2298 8987

## South America

**AR – Argentina,** Buenos Aires  
Tel: +54 3327 44 4129

**BR – Brazil,** Sao Jose dos Campos  
Tel: +55 800 727 5374

**CL – Chile,** Santiago  
Tel: +56 2 623 1216

**MX – Mexico,** Toluca  
Tel: +52 72 2275 4200

European Product Information Centre  
Free phone: 00 800 27 27 5374  
(from AT, BE, CH, CZ, DE, DK, EE, ES, FI,  
FR, IE, IL, IS, IT, LU, MT, NL, NO, PL, PT, RU,  
SE, SK, UK, ZA)

